

Rolling Bearings

Content

Foreword 7

1. Basic Calculations 8

 1.1 Dynamic Load 8

 1.1.1 Basic Dynamic Load Rating 8

 1.1.2 Life 8

 1.1.3 Equivalent Dynamic Load 14

 1.1.4 Temperature Influence 17

 1.2 Static Load 17

 1.2.1 Basic Static Load Rating 17

 1.2.2 Equivalent Static Load 17

 1.2.3 Bearing Safety under Static Load 18

 1.3 Limiting Speed 19

2. Rolling Bearing Design Data 20

 2.1 Boundary Dimensions 20

 2.2 Designation 20

 2.3 Tolerance 27

 2.4 Internal Clearance 45

 2.5 Cages 48

 2.6 Shields and Seals 48

3. Bearing Arrangement Design 49

 3.1 General Principles of Rolling Bearing Arrangement Design 49

 3.2 Bearing Location 50

 3.2.1 Radial Location of Bearing 50

 3.2.2 Axial Securing of Bearing 52

 3.3 Sealing 58

 3.3.1 Non-Contact Sealing 58

 3.3.2 Rubber Sealing 59

 3.3.3 Combined Sealing 60

4. Bearing Lubrication 61

 4.1 Grease Lubrication 61

 4.1.1 Relubrication Interval 61

 4.1.2 Bearing Greases 64

 4.2 Oil Lubrication 64

 4.2.1 Bearing Oils 64

 4.3 Lubrication with Solid Lubricants 65

5. Mounting and Dismounting Rolling Bearings 67

6. Standards 68

Single Row Deep Groove Ball Bearings 70

Single Row Angular Contact Ball Bearings 122

Double Row Angular Contact Ball Bearings 130

Double Row Self-Aligning Ball Bearings 143

Thrust ball bearings 153

Single Row Cylindrical Roller Bearings 166

Needle bearings 166

 Needle bearings with guide ribs without and with inner ring 240

 Drawn cup needle roller bearings open / closed 258

 Inner rings 271

Single Row Tapered Roller Bearings 277

Double - Row Spherical Roller Bearings 294

Spherical Plain Bearings 323

Single-row full-complement cylindrical roller bearings 328

Double-row full-complement cylindrical roller bearings 340

Spherical roller thrust bearings 356

Cylindrical roller thrust bearings 367

Insert bearings and Housing units 377

Accessories 403

Special Cylindrical Roller Bearings for Railway Vehicles 419

Special Double Row Ball Bearings for Textile Machines and Measuring Instruments 424

Special Double Row Bearings for Water Pumps of Combustion Engines 429

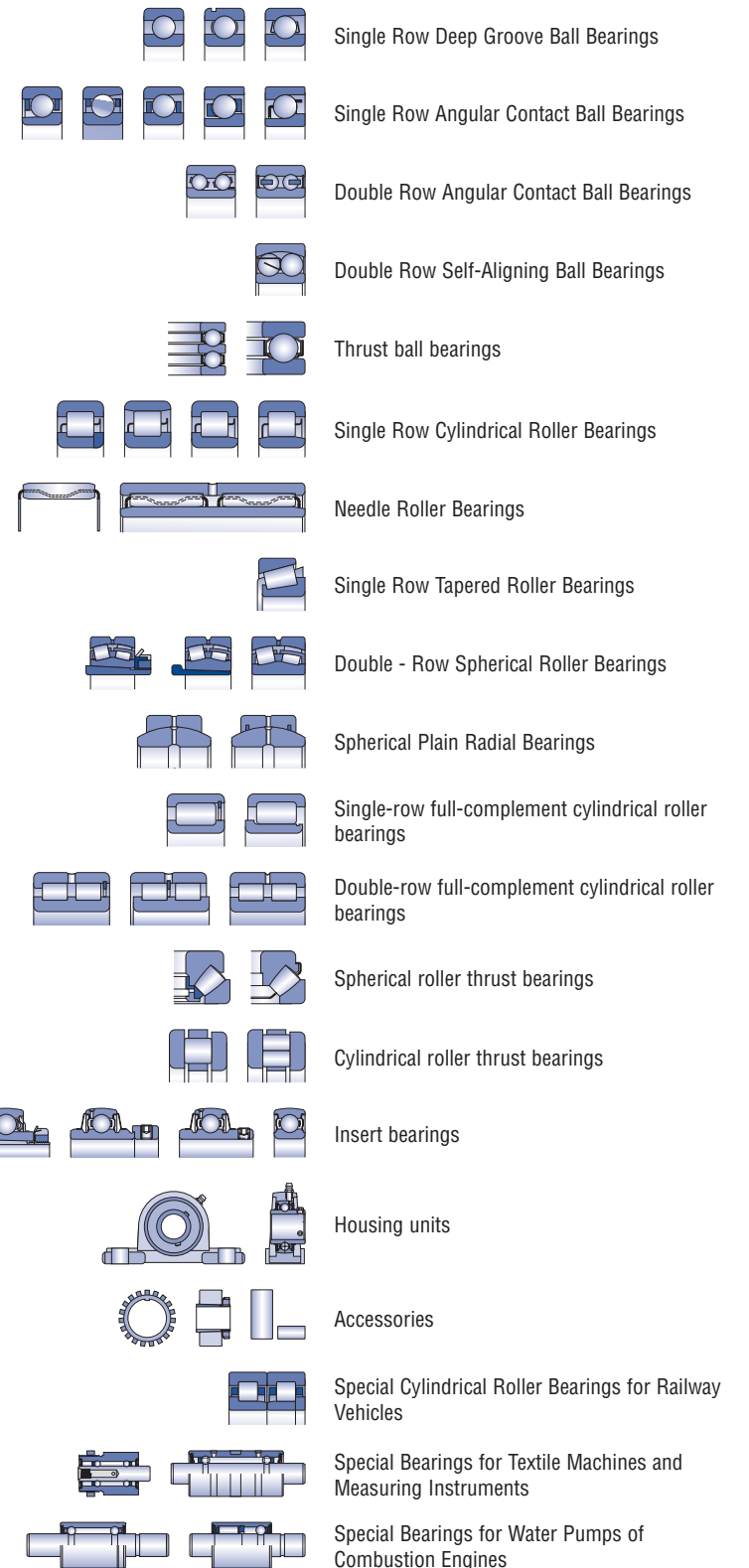

Foreword

Publication Rolling Bearings shows a survey of standardized rolling bearings and accessories being produced and delivered under designation KINEX.

In the design, production, storage and sales of the rolling bearings international standards ISO and national standards are used.

Technical section of the publication contains the most important facts concerning calculations, the design data about the arrangement design, lubrication, as well as mounting and dismounting rolling bearings. The produced standardized rolling bearings and accessories in the basic design and in the main applications from the basic design, as e.g. bearings with tapered bore, shielded bearings or bearings with snap ring groove on outer ring, etc., are shown in the "Rolling Bearings Dimension Tables" part.

1. Basic Calculations

Required bearing size is determined by the action of the external forces and according to the bearing required life and its reliability in the arrangement. Magnitude, direction and kind of load acting on the bearing, as well as the operating speed, are decisive for the type and bearing size selection. Other special or important conditions of each individual arrangement must be taken into account, e.g. operating temperature, limited space availability, simplicity of mounting, lubrication requirements, sealing, etc., and all of these can influence selection of the most suitable bearing. For given concrete conditions various bearing types can meet those requirements.

From the point of view of outer load acting and the bearing function in respective arrangement or unit we distinguish two types of the rolling bearing load in the bearing technique:

- when rolling bearing rings are relatively rotating against each other and bearing is under outer load (which is valid for most bearings), this is called dynamic bearing load,

- when rolling bearing rings either do not move against each other or they move only very slowly, the bearing carries an oscillating motion or the outer load acts for a shorter time than one bearing revolution, this is called static bearing load.

For bearing safety calculation, the life limited by bearing breakdown due to material fatigue of a bearing component is decisive in the first case. In the second case there are durable deformations of functional surfaces on the contact surfaces of rolling elements and raceways.

1.1 Dynamic Load 1.1.1 Basic Dynamic Load Rating

Basic dynamic load rating is a constant invariable load which the bearing can theoretically carry at the nominal life of one million revolutions.

For radial bearings, the radial dynamic load rating C_r refers to constant load. For thrust bearings, the axial dynamic load rating C_a refers to unvariable, purely axial load, acting centrally.

Basic dynamic load ratings C_r and C_a , whose size depends on bearing dimensions, rolling element number, material and bearing design, are shown for each bearing in the dimension tables. Values of the basic dynamic load ratings were stated according to the standard ISO 281. These values are verified in testing equipments and by operation results.

1.1.2 Life

Rolling bearing life is defined as the number of revolution carried out by one bearing ring against the other ring, until the first signs of material fatigue occur on one ring or the rolling element.

Great differences in life can occur among bearings of the same type, that is why according to the standard ISO 281 the basic life is used as the basis for life calculation, i.e. life shown by the operation time attained or exceeded by a bearing group at 90% reliability.

Life Equation

Nominal bearing life is mathematically defined by the life equation valid for all bearing types.

$$L_{10} = \left(\frac{C}{P}\right)^p \text{ or } \frac{C}{P} \cdot 5 \cdot (L_{10})^{\frac{1}{p}}$$

L_{10} - nominal life	[10 ⁶ rev]
C - basic dynamic load rating (values C_r, C_a are given in the dimension tables)	[kN]
P - equivalent dynamic bearing load (equations for P_r, P_a calculations are in section 1.1.3 and at each design group of bearings)	[kN]
p - exponent for ball bearings $p = 3$ for cylindrical, needle-, spherical- and tapered roller bearings	$p = \frac{10}{3}$

C/P ratio in dependence on life L_{10}

Table 1

For ball bearings				For cylindrical roller, needle roller, spherical roller and tapered roller bearings			
Life L_{10}	$\frac{C}{P}$	Life L_{10}	$\frac{C}{P}$	Life L_{10}	$\frac{C}{P}$	Life L_{10}	$\frac{C}{P}$
10 ⁶ rev		10 ⁶ rev		10 ⁶ rev		10 ⁶ rev	
0.5	0.793	600	8.43	0.5	0.812	600	6.81
0.75	0.909	650	8.66	0.75	0.917	650	6.98
1	1	700	8.88	1	1	700	7.14
1.5	1.14	750	9.09	1.5	1.13	750	7.29
2	1.26	800	9.28	2	1.24	800	7.43
3	1.44	850	9.47	3	1.39	850	7.56
4	1.59	900	9.65	4	1.52	900	7.70
5	1.71	950	9.83	5	1.62	950	7.82
6	1.82	1 000	10	6	1.71	1 000	7.94
8	2	1 100	10.3	8	1.87	1 100	8.17
10	2.15	1 200	10.6	10	2	1 200	8.39
12	2.29	1 300	10.9	12	2.11	1 300	8.59
14	2.41	1 400	11.2	14	2.21	1 400	8.79
16	2.52	1 500	11.4	16	2.30	1 500	8.97
18	2.62	1 600	11.7	18	2.38	1 600	9.15
20	2.71	1 700	11.9	20	2.46	1 700	9.31
25	2.92	1 800	12.2	25	2.63	1 800	9.48
30	3.11	1 900	12.4	30	2.77	1 900	9.63
35	3.27	2 000	12.6	35	2.91	2 000	9.78
40	3.42	2 200	13	40	3.02	2 200	10.1
45	3.56	2 400	13.4	45	3.13	2 400	10.3
50	3.68	2 600	13.8	50	3.23	2 600	10.6
60	3.91	2 800	14.1	60	3.42	2 800	10.8
70	4.12	3 000	14.4	70	3.58	3 000	11
80	4.31	3 500	15.2	80	3.72	3 500	11.5
90	4.48	4 000	15.9	90	3.86	4 000	12
100	4.64	4 500	16.5	100	3.98	4 500	12.5
120	4.93	5 000	17.1	120	4.20	5 000	12.9
140	5.19	5 500	17.7	140	4.40	5 500	13.2
160	5.43	6 000	18.2	160	4.58	6 000	13.6
180	5.65	7 000	19.1	180	4.75	7 000	14.2
200	5.85	8 000	20	200	4.90	8 000	14.8
250	6.30	9 000	20.8	250	5.24	9 000	15.4
300	6.69	10 000	21.5	300	5.54	10 000	15.8
350	7.05	12 500	23.2	350	5.80	12 500	16.9
400	7.37	15 000	24.7	400	6.03	15 000	17.9
450	7.66	17 500	26	450	6.25	17 500	18.7
500	7.94	20 000	27.1	500	6.45	20 000	19.5
550	8.19	25 000	29.2	550	6.64	25 000	20.9

Table 1 shows dependence of the life L_{10} in million revolutions and respective ratio C/P.

If the rotational speed does not change, the revised life calculation expressing the nominal life in operation hours can be used:

$$L_{10h} = \left(\frac{C}{P}\right)^p \cdot \frac{10^6}{60 \cdot n} \quad \begin{array}{l} h - \text{nominal life} \\ n - \text{rotational speed} \end{array} \quad \begin{array}{l} [\text{h}] \\ [\text{min}^{-1}] \end{array}$$

C/P dependence from the nominal life L_{10} and the rotational speed n is shown for ball bearings in Table 2, for cylindrical roller, needle roller, spherical roller and tapered roller bearings in Table 3.

In arrangements of the axles of road and railway vehicles the nominal life can be expressed by a revised relation in the volume of kilometers travelled.

$$L_{10km} = \left(\frac{C}{P}\right)^p \cdot \frac{\pi D}{1000}$$

L_{10km} - nominal life
D - wheel diameter

[10⁶ km]
[m]

Reference Nominal Life Values

In cases, where the life for a given arrangement is not specified in advance, the values in tables 4 and 5 can be considered as adequate

Reference Nominal Life Values in Operating Hours

Table 4

Machine Type	Nominal Life L_{10h} h
Devices and tools rarely used	1 000
Household electric appliances, small fans	2 000 to 4 000
Machines for intermittent operation, hand tools, workshop lifting tackles, agricultural machines	4 000 to 8 000
Machines with intermittent operation where high reliability is required, auxiliary power station equipment, belt conveyors, trucks, elevators	8 000 to 15 000
Rolling mills	6 000 to 12 000
Machines operating 8 - 16 hours - stationary electric motors, gear drives, textile machine spindles, plastic material processing machines, printing machines, cranes	15 000 to 30 000
Machine tools in general	20 000 to 30 000
Machines with continuous operation - stationary electric machines, conveying equipment, roller conveyors, pumps, centrifuges, blowers, compressors, hammer mills, crushers, briquetting presses, mine hoists, rope pulleys	40 000 to 60 000
Machines with continuous operation for high operating reliability - power station plants, water works machinery, paper making machines, ship machines	100 000 to 200 000

Reference Nominal Life Values in Kilometers

Table 5

Vehicle Type	Nominal Life L_{10km} km
Road vehicle wheels :	
motor cycles	60 000
passenger cars	150 000 to 250 000
trucks, buses	400 000 to 500 000
Axle box bearings for railway vehicles:	
freight wagons (according to UIC) under continuous maximum axle load acting	800 000
tram cars	1 500 000
railway passenger carriages	3 000 000
motor wagons and motor units	3 000 000 to 4 000 000
locomotives	3 000 000 to 5 000 000

Equation of Adjusted Life

Adjusted life is a corrected nominal life, where by calculation not only of the load but the influence of bearing components, material, physical, mechanical, and chemical qualities of lubricants and the temperature regime of the bearing the operating environment are taken into account.

$$L_{na} = a_1 \cdot a_{23} \cdot L_{10}$$

L_{na} - adjusted life for (100-n)% reliability and other usual operation conditions [10⁶ rev]
 a_1 - life factor for other than 90% reliability, see Table 6
 a_{23} - life factor of material, lubricant, production technology and operation conditions, see Pict. 1
 L_{10} - nominal life

Factor a_1 Values

Table 6

Reliability (%)	L_n	a_1
90	L_{10}	1.00
95	L_5	0.62
96	L_4	0.53
97	L_3	0.44
98	L_2	0.33
99	L_1	0.21

We can find basic values of a_{23} by using the diagram in Pict. 1.

$$\chi = \frac{\nu}{\nu_1}$$

ν - kinematic lubricant viscosity by operation bearing temperature [mm².s⁻¹]
 ν_1 - kinematic viscosity for defined rotational speed and selected bearing dimensions [mm².s⁻¹]

Values ν and ν_1 are determined according to the diagrams in Pict. 23 or 24.

In the diagram, Pict. 1, the line I is valid for radial ball bearings operating in a very clean environment. In other cases the factor a_{23} is lower, depending on the environment cleanliness, and the decreasing tendency is dependent on the bearing design group in following order:

- angular contact ball bearings
- tapered roller bearings
- cylindrical roller bearings
- double row self-aligning ball bearings
- spherical roller bearings

Line II can be used when stating the factor a_{23} for spherical roller bearings operating in a dusty environment.

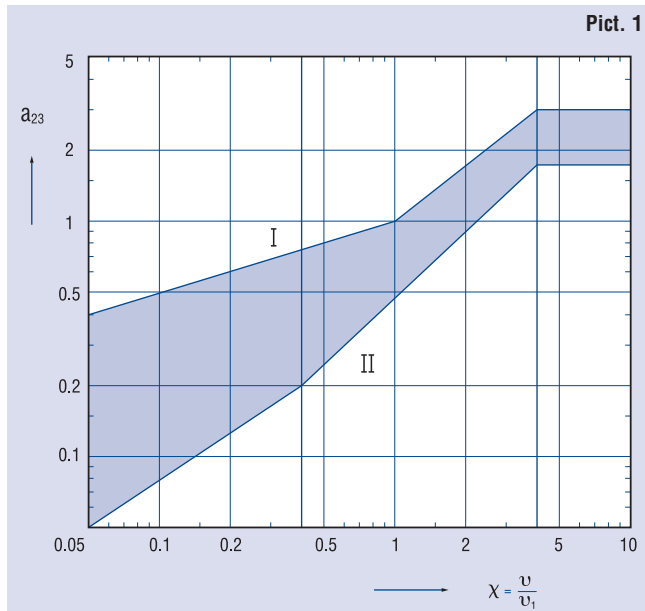

1.1.3 Equivalent Dynamic Load

In the arrangement the bearing is subjected to generally acting forces in various magnitudes, at various rotational speeds and with different acting period. From the point of view of calculation methodology the acting forces should be re-calculated into the constant load, by which the bearing will have the same life as it reaches in the conditions of the actual load.

Such a re-calculated constant radial or axial load is called the equivalent load P_e or P_r (radial) or P_a (axial).

Combined Load Constant Load

The outer forces acting on a bearing are not changed both from the point of view of size and time dependence.

Radial Bearings

If the radial bearings are simultaneously subjected to constant forces in radial and axial directions, the following equation is valid for calculating the radial equivalent dynamic load:

$$P_r = X \cdot F_r + Y \cdot F_a \quad [\text{kN}]$$

P_r	- radial equivalent dynamic load	[kN]
F_r	- radial bearing load	[kN]
F_a	- axial bearing load	[kN]
X	- radial dynamic load factor	
Y	- axial dynamic load factor	

Factors X and Y depend on the ratio F_a/F_r . Values X and Y are shown in the dimension tables or in the introduction to each bearing type where closer information regarding bearing calculation of the respective type is given.

Thrust Bearings

Thrust ball bearings can carry only forces acting in axial direction and the following equation is valid for calculating axial equivalent dynamic load:

$$P_a = F_a \quad [\text{kN}]$$

P_a	- axial equivalent dynamic load	[kN]
F_a	- axial bearing load	[kN]

Fluctuating Load

Spherical roller thrust bearings can also carry some radial load, but only by simultaneous acting of axial load, when condition $F_r \leq 0.55 F_a$ must be fulfilled. Axial equivalent dynamic load is calculated from equation

$$P_a = F_a + 1.2 F_r \quad [\text{kN}]$$

Real fluctuating load, whose time course we know, is for calculation replaced by mean hypothetical load. This hypothetical load has the same influence on the bearing as the fluctuating load.

Change of Load Magnitude by Constant Rotational Speed

If the bearing is subjected to a load in a constant direction, whose magnitude is changed in dependence on time and the rotational speed is constant (Pict. 2), we can calculate the mean hypothetical load F_s according to the following equation

$$F_s = \left(\sum_{i=1}^n F_i^3 \cdot \frac{q_i}{100} \right)^{\frac{1}{3}} \quad [\text{kN}]$$

F_s	- mean hypothetical constant load	[kN]
$F_i = F_1, \dots, F_n$	- constant partial actual load	[kN]
$q_i = q_1, \dots, q_n$	- share of fractional load effects	[%]

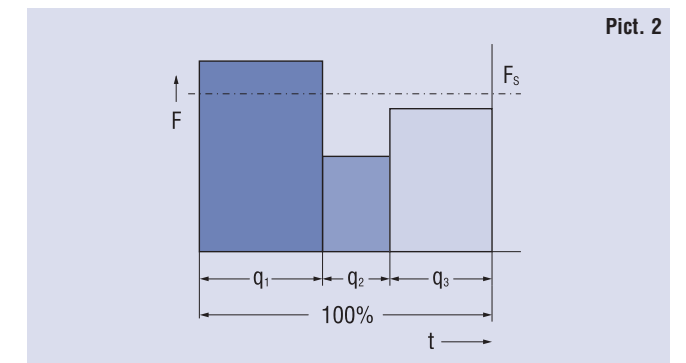

At constant rotational speed with linear change of the load in constant direction (Pict. 3) the mean hypothetical load can be calculated from equation

$$F_s = \frac{F_{\min} + 2F_{\max}}{3} \quad [\text{kN}]$$

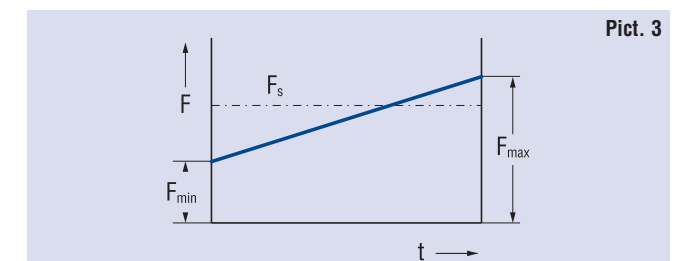

If the actual load has a sine behaviour (Pict. 4), the mean hypothetical load is

$$F_s = 0.75 \cdot F_{\max} \quad [\text{kN}]$$

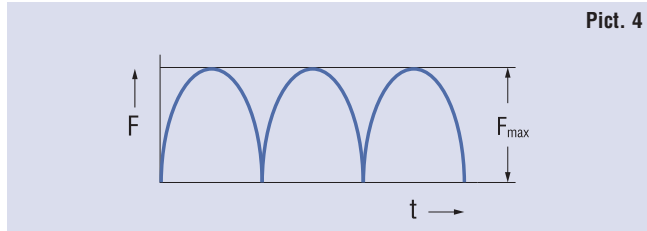

Change of Load Magnitude by Change of Rotational Speed

If the bearing is subjected in time to a varying load and the rotational speed is being changed, the mean hypothetical load is calculated from equation

$$F_s = \left(\frac{\sum_{i=1}^n F_i^3 \cdot q_i \cdot n_i}{\sum_{i=1}^n q_i \cdot n_i} \right)^{\frac{1}{3}} \quad [\text{kN}]$$

$n_i = n_1, \dots, n_n$ - constant rotational speed in time of partial loads F_1, \dots, F_n acting [min⁻¹]
 $q_i = q_1, \dots, q_n$ - share of partial load and rotational speed acting [%]

If in dependence on time only the rotational speed is changed, the mean hypothetical constant rotational speed is calculated from equation

$$n_s = \frac{\sum_{i=1}^n q_i \cdot n_i}{100} \quad [\text{min}^{-1}]$$

n_s - mean rotational speed [min⁻¹]

Oscillating Motion of Bearing

By oscillating motion with amplitude γ (Pict. 5) it is the simplest way of substituting the oscillating motion by hypothetical rotation, when the rotational speed equals the oscillation frequency. For radial bearings the mean hypothetical load is calculated from the equation:

$$F_s = F_r \left(\frac{\gamma}{90} \right)^{\frac{1}{p}} \quad [\text{kN}]$$

F_s - mean hypothetical load [kN]
 F_r - actual radial load [kN]
 γ - oscillating motion amplitude [°]
 p - exponent $p = 3$ for ball bearings

$p = \frac{10}{3}$ for cylindrical roller, needle roller, spherical roller and tapered roller bearings

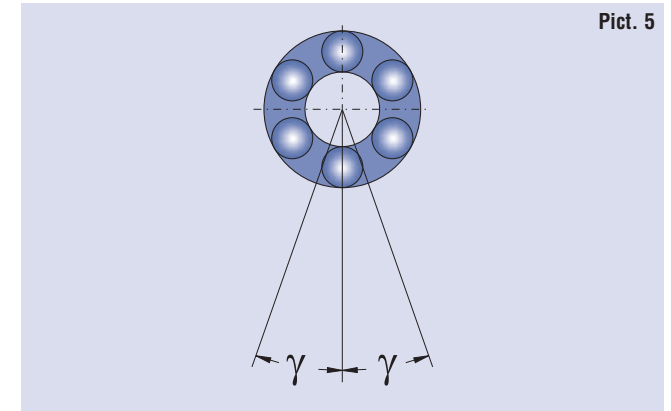

1.1.4 Temperature Influence

Delivered bearing assortment is determined for usage in an environment with operating temperatures up to 120 °C. Exceptions are double row spherical roller bearings which can work at temperatures up to 180 °C, and single row ball bearings with seals (RS, 2RS, RSR, 2RSR) applicable up to 110 °C, with seals RS2, -2RS2 applicable up to 180 °C.

For higher operation temperatures the bearings are produced so that their necessary physical and mechanical qualities and dimensional stability can be secured.

Values of the basic dynamic load ratings C_r or C_a shown in the dimension tables of this publication should be multiplied by factor f_t , shown in Table 7.

Values of f_t Factor

Table 7

Operating Temperature to [°C]	150	200	250	300
Factor f_t	0.95	0.9	0.75	0.6

1.2 Static Load 1.2.1 Basic Static Load Rating

Radial basic static load rating C_{0r} and axial basic static load rating C_{0a} are shown for each bearing in the dimension tables of this publication. Values C_{0r} and C_{0a} were stated by a calculation according to the standard ISO 76.

Basic static load rating is the load which corresponds to calculated contact stresses at the most heavily loaded contact zone of the rolling element and bearing raceway:

- 4 600 MPa for double row self-aligning ball bearings
- 4 200 MPa for the other ball bearings
- 4 000 MPa for cylindrical roller, needle roller, spherical roller and tapered roller bearings

1.2.2 Equivalent Static Load

Equivalent static load is a re-calculated radial load P_{0r} for radial bearings and axial axis load P_{0a} for thrust bearings.

$P_{0r} = X_0 F_r + Y_0 F_a$	[kN]
$P_{0a} = X_0 F_r + Y_0 F_a$	[kN]
P_{0r} - radial static equivalent load	[kN]
P_{0a} - axial static equivalent load	[kN]
F_r - radial bearing load	[kN]
F_a - axial bearing load	[kN]
X_0 - radial load factor	
Y_0 - axial load factor	

Factor s_0

Table 8

Bearing motion	Type of load, demands on bearing running	s_0	
		Ball Bearings	Cylindrical roller, needle roller, spherical roller, tapered roller bearings
Rotary	distinct impact load, high demands on smooth running	2	4
	after static loading bearing rotates under smaller load	1.5	3
	normal demands on smooth running		
	normal operating conditions and normal demands on running	1	1.5
	smooth impact-free operating	0.5	1
Oscillating	small oscillation angle with high frequency, with uneven impact loading	2	3.5
	large oscillating angle with low frequency and with approximately constant periodic load	1.5	2.5
Non-rotary	distinct impact load	1.5 to 1	3 to 2
	normal and small load, no special demands on bearing operation	1 to 0.4	2 to 0.8
	spherical roller thrust bearings at all kinds of motions and loads	-	4

Factors X_0 and Y_0 are given for individual bearings in the dimensional tables of this publication. Subsequently, closer data for stating the equivalent static load of given bearing type are also given here.

1.2.3 Bearing Safety under Static Load

In practice the bearing safety under static load is found by the ratio C_{or}/P_{or} or C_{oa}/P_{oa} and is compared with data in table 8, where the values of the least permissible factors s_0 for various operation conditions are shown.

$$s_0 = \frac{C_{or}}{P_{or}} \text{ or } \frac{C_{oa}}{P_{oa}}$$

s_0	- safety factor under static load	
C_{or}	- radial basic static load rating	[kN]
C_{oa}	- axial basic static load rating	[kN]
P_{or}	- radial equivalent static load or maximum acting impact force $F_{r \max}$ (Pict. 6) under distinct impact load	[kN]
P_{oa}	- axial equivalent static load or maximum acting impact force $F_{a \max}$ (Pict. 6) under distinct impact load	[kN]

Pict. 6

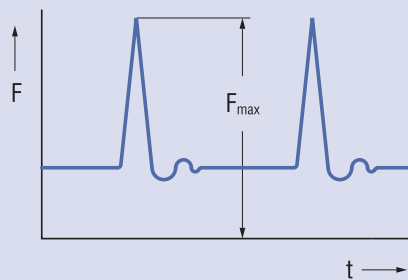

1.3 Limiting Speed

Limiting speed depends on the bearing type, its accuracy, cage design, internal clearance, operating conditions in arrangement, kind of lubrication and on other factors. This influence summary determines the heat generation in the bearing and also limited rotational speed which is first of all limited by the lubricant operating temperature.

For orientation, limiting rotational speed values are shown in the dimension tables for individual bearings in normal tolerance class, both for grease and oil lubrication.

Given values are valid under presumption of adequate load ($L_{10h} \geq 100\,000$ h), normal operating conditions and cooling.

It is also necessary to reduce the limiting speed values for radial bearings which are permanently loaded by relatively great axial force. The resulting limiting speed values depend on the ratio of axial and radial load F_a/F_r .

The shown limiting speed can be exceeded for ball bearings up to 3 times, cylindrical roller bearings up to 2 times, for other bearings except spherical roller and tapered roller bearings up to 1.5 times and for spherical roller bearings 1.3 times.

This exceeding requires :

- adaptation of lubrication and cooling
- higher bearing tolerance class and corresponding accuracy of the abutment parts
- higher radial clearance than normal
- cage of suitable design and material

2. Rolling Bearing Design Data

2.1 Boundary Dimensions

Bearings introduced in this publication are made in dimensions complying with the international standards ISO 15, ISO 355 and ISO 104.

In the dimensional plan each bearing bore diameter d corresponds to several outer diameters D and various widths are added to them - B or T for radial and H for thrust bearings. Bearings having the same bore diameter and outer diameter belong to one diameter series which is designated according to the ascending outer diameter by figures 7, 8, 9, 0, 1, 2, 3, 4. Within each diameter series there are bearings of various width series according to the ascending width: 8, 0, 1, 2, 3, 4, 5, 6 for radial bearings and 7, 9, 1, 2 for thrust bearings. Diameter and width series form dimension series which are designated by a two digit number, where the first digit indicates the width series and the second the diameter one, as shown in Pict. 7.

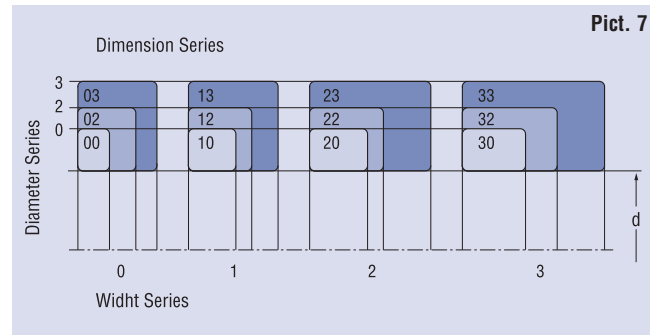

Dimensional plan also includes the bearing ring chamfer dimensions, so called mounting chamfer, see Pict. 8

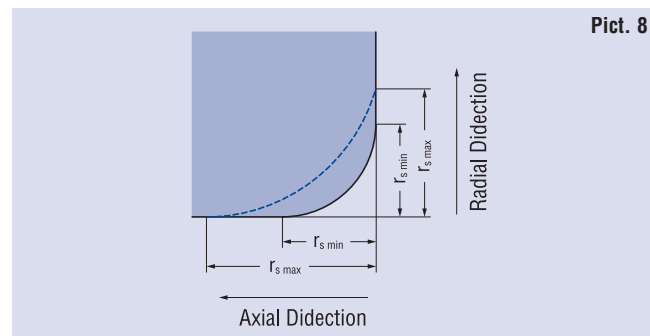

2.2 Designation

Bearing designation is created by numerical and letter symbols indicating the type, size and design of the bearing, see the scheme.

In the basic design the bearings are designated by a basic designation which consists of bearing type and size designation. The type designation is usually created by the symbol indicating the bearing design (see position 3 in the scheme) and the symbol for dimension series or diameter series (positions 4 and 5 in the scheme), e.g. bearing type 223, 302, NJ22, 511, 62, 12, etc. Bearing size designation is created by symbols for the nominal bore diameter d (see position 6 in the scheme).

Bearings with bore diameter $d < 10$ mm:

Digit separated by a slash, or the last digit indicates directly the bore diameter in mm, e.g. 619/2, 624.

Overview of chamfer limiting values according to international standard ISO 582 is given in Table 9.

Limiting Dimensions of Mounting Chamfer

Table 9

r_s min	Radial Bearings except Tapered Roller Bearings				Tapered Roller Bearings				Thrust Bearings
	d or D above	to	r_s max in radial direction	in axial direction	d or D above	to	r_s max in radial direction	in axial direction	r_s max in radial and axial direction
mm									
0.15	-	-	0.3	0.6	-	-	-	-	0.3
0.2	-	-	0.5	0.8	-	-	-	-	0.5
0.3	-	40	0.6	1	-	40	0.7	1.4	0.8
	40	-	0.8	1	40	-	0.9	1.6	0.8
0.6	-	40	1	2	-	40	1.1	1.7	1.5
	40	-	1.3	2	40	-	1.3	2	1.5
1	-	50	1.5	3	-	50	1.6	2.5	2.2
	50	-	1.9	3	50	-	1.9	3	2.2
1.1	-	120	2	3.5	-	-	-	-	2.7
	120	-	2.5	4	-	-	-	-	2.7
1.5	-	120	2.3	4	-	120	2.3	3	3.5
	120	-	3	5	120	250	2.8	3.5	3.5
	-	-	-	-	250	-	3.5	4	3.5
2	-	80	3	4.5	-	120	2.8	4	4
	80	220	3.5	5	120	250	3.5	4.5	4
	220	-	3.8	6	250	-	4	5	4
2.1	-	280	4	6.5	-	-	-	-	4.5
	280	-	4.5	7	-	-	-	-	4.5
2.5	-	100	3.8	6	-	120	3.5	5	-
	100	280	4.5	6	120	250	4	5.5	-
	280	-	5	7	250	-	4.5	6	-
3	-	280	5	8	-	120	4	5.5	5.5
	280	-	5.5	8	120	250	4.5	6.5	5.5
	-	-	-	-	250	400	5	7	5.5
	-	-	-	-	400	-	5.5	7.5	5.5
4	-	-	6.5	9	-	120	5	7	6.5
	-	-	-	-	120	250	5.5	7.5	6.5
	-	-	-	-	250	400	6	8	6.5
	-	-	-	-	400	-	6.5	8.5	6.5
5	-	-	8	10	-	180	6.5	8	8
	-	-	-	-	180	-	7.5	9	8
6	-	-	10	13	-	180	7.5	10	10
	-	-	-	-	180	-	9	11	10
7.5	-	-	12.5	17	-	-	-	-	12.5
9.5	-	-	15	19	-	-	-	-	15
12	-	-	18	24	-	-	-	-	18
15	-	-	21	30	-	-	-	-	21

Bearings with bore diameter $d = 10$ to 17 mm:

double digit number 00 indicates bore $d = 10$ mm, e.g. 6200
01 $d = 12$ mm, e.g. 6001
02 $d = 15$ mm, e.g. 6202
03 $d = 17$ mm, e.g. 6303

An exception to the designation are separable single row ball bearings - types E and BO, where the double digit number indicates directly the bore diameter in mm, e.g. E17.

Bearings with bore diameter $d = 20$ to 480 mm:

Bore diameter is a fivefold of the last double digit number, e.g. bearing 1320 has the bore diameter $d = 20 \times 5 = 100$.

An exception create bearings with bore $d = 22, 28, \text{ and } 32 \text{ mm}$, where the double digit number separated by a slash indicates directly the bore diameter in mm, e.g. 320/32AX, further separable single row ball bearings - type E and single row cylindrical roller bearings - type E, where the double digit number, or number indicates directly the bore diameter in mm, e.g.: E20.

Bearings with bore diameter $d \geq 500 \text{ mm}$

The last three or four digit number separated by a slash indicates directly the bore diameter in mm, e.g. 230/530M, NU29/1060.

Bearings produced in different design than standard are designated by so called complete designation, see the scheme. It consists of the basic designation and prefixes and suffixes indicating the difference from the basic design.

Meaning of Prefixes and Suffixes

In compliance with complete designation a survey and meaning of used prefixes and suffixes is given in the following part. (Number in brackets at individual groups corresponds to the position number in the scheme).

Prefixes Material Different from Standard Bearing Steel (1)

X corrosion resisiting steel, e.g. X 623
T case hardened steel, e.g. T 32240

Incomplete Bearing (2)

L removable ring of separable bearing, e.g. LNU 206, for thrust ball bearings without shaft washer, e.g. L 51215
R separable bearing without removable ring, e.g. RNU 206 or R N310
E single shaft washer of thrust roller bearing, e.g. E 51314
W single housing washer of thrust ball bearing, e.g. W 51411
K cage with rolling elements, e.g. K NU320

Suffixes Difference of Internal Design (7)

A single row angular contact ball bearing, contact angle $\alpha = 25^\circ$, e.g. B7205ATB P5
AA single row angular contact ball bearing with contact angle $\alpha = 26^\circ$, e.g. B72010AATB P4
B single row angular contact ball bearing with contact angle $\alpha = 40^\circ$, e.g. 7304B
BE single row angular contact ball bearing with contact angle $\alpha = 40^\circ$, in new design, e.g. 7310BETNG
C Single row angular contact ball bearing with contact angle $\alpha = 15^\circ$, e.g. B7202CTB P4
CA single row angular contact ball bearing with contact angle $\alpha = 12^\circ$, e.g. B7202CATB P5
CB single row angular contact ball bearing with contact angle $\alpha = 10^\circ$, e.g. B7206CBTB P4
CC double row spherical roller bearing in new design, e.g. 23996CCM
D single row ball bearing - type 160 with higher load rating, e.g. 16004D
E single row cylindrical roller bearing with higher load rating, e.g. NU209E

Difference of Boundary Dimensions

X change of boundary dimensions, introduced by new international standards, e.g. 32028AX

Shields or Seals

RS seal on one side, e.g. 6304RS
-2RS seals on both sides, e.g. 6204-2RS
RSN seal on one side and snap ring groove in outer ring opposite to seal side, e.g. 6306RSN
RSNB seal on one side and snap ring groove in outer ring on the same side as seal, e.g. 6210RSNB
-2RSN seals on both sides and snap ring groove in outer ring, e.g. 6310-2RSN
RSR seal on one side adhering to flat surface of inner ring, e.g. 624RSR
-2RSR seals on both sides adhering to flat surface of inner ring, e.g. 608-2RSR
Z metal shield on one side, e.g. 6206Z

-2Z metal shields on both sides, e.g. 6304-2Z
ZN metal shield on one side and snap ring groove in outer ring opposite to metal shield, e.g. 6208ZN
ZNB metal shield on one side and snap ring groove in outer ring on the same side as shield, e.g. 6306ZNB
-2ZN metal shields on both sides and snap ring groove in outer ring, e.g. 6208-2ZN
ZR metal shield on one side adhering to flat surface of inner ring, e.g. 608ZR
-2ZR metal shields on both sides adhering to flat surface of inner ring, e.g. 608-2ZR

Bearing Ring Design Variation (10)

K tapered bore, taper 1:12, e.g. 6207K
K30 tapered bore, taper 1:30, e.g. 24064K30M
N snap ring groove in outer ring, e.g. 6308N
NR snap ring groove in outer ring and inserted snap ring, e.g. 6310NR
NX snap ring groove in outer ring whose boundary dimensions do not correspond to ISO 464, e.g. 6210NX
D split inner ring, e.g. 3309D
W33 groove and lubrication holes in bearing outer ring surface, e.g. 23148W33M
O lubrication grooves in bearing outer ring, e.g. NU10140

Cages (11)

Cage material for bearings in basic design is not usually indicated.
J pressed steel cage, rolling element centred, e.g. 6034J
Y pressed brass cage, rolling elements centred, e.g. 6001Y
F machined steel cage, rolling elements centred, e.g. 6418F
L machined light metal cage, rolling elements centred, e.g. NG180L C3S0
M machined brass or bronze cage, rolling elements centred, e.g. NU330M
T machined cage made of textite, rolling elements centred, e.g. 6005T
TN machined cage made of polyamide or similar plastic, rolling elements centred, e.g. 6207TN
TNG machined cage made of polyamide or similar plastic with glass fibres, rolling elements centred, e.g. 2305TNG

Cage design (introduced symbols are always used in connection with cage material symbols).

A cage centred on outer ring, e.g. NU226MA
B cage centred on inner ring, e.g. 6210TB
P machined window-type cage, e.g. NU1060MAP
H one-piece open-type cage, e.g. 6209TNH
S cage with lubrication grooves, e.g. NJ418MAS
V bearing without cage, full rolling element number, e.g. NU209V

Tolerance Class (12)

P0 standard tolerance class (not indicated), e.g. 6204
P6 higher tolerance class than standard, e.g. 6322 P6
P5 higher tolerance class than P6, e.g. 6201 P5
P5A in some parameters higher tolerance class than P5, e.g. 6006TB P5A
P4 higher tolerance class than P5, e.g. 6207 P4
P4A in some parameters higher tolerance class than P4, e.g. 6007 P4A
P2 higher tolerance class than P4, e.g. 6306 P2
P6E higher tolerance class for rotating electric machines, e.g. 6204 P6E

Clearances (13)	C2	clearance less than normal, e.g. 608 C2 normal clearance (not indicated), e.g. 6204
	C3	clearance greater than normal, e.g. 6310 C3
	C4	clearance greater than C3, e.g. NU320M C4
	C5	clearance greater than C4, e.g. 22330M C5
	NA	radial clearance for bearings with non-interchangeable rings (always after radial clearance symbol), e.g. NU215 P63NA
	R...	radial clearance in non-standardized range (range in mm), e.g. 6210A R10-20
A...	axial clearance in non-standardized range (range in mm), e.g. 3210 A20-30	

Vibration Level (14)	C6	reduced vibration level lower than normal (not indicated) e.g. 6304 C6
	C06	reduced vibration level lower than C6, e.g. 6205 C06
	C66	reduced vibration level lower than C06, e.g. 6205 C66
	Concrete C06 and C66 values are determined after negotiations between customer and supplier. <i>Note: Bearings in tolerance class P5 and higher have vibration level C6</i>	

Increased Operation Safety C7, C8, C9 - bearings with increased operation safety determined primarily for aircraft industry, e.g. 16008 C8

Symbol Combination (12 - 15) Symbols for tolerance class, bearing internal clearances, vibration levels and increased operation safety are combined, when symbol C is omitted from the second and following special bearing characteristics, e.g.:

P6 + C3 = P63	e.g. 6211 P63
P6 + C8 = P68	e.g. 16002 P68
C3 + C6 = C36	e.g. 6303-2RS C36
P5 + C3 + C9 = P539	e.g. 6205MA P539
P6 + C2NA + C6 = P626NA	e.g. NU1038 P626NA

Bearing Arrangement in Matched Set (16) Designation of the arrangement in matched sets of two, three or four bearings consists of symbols indicating the bearing arrangement and symbols determining internal clearance, or preload of matched bearings.
Besides symbols shown in the table also U symbol is used and it indicates that respective bearings can be universally matched, e.g. B7003CTA P4UL.

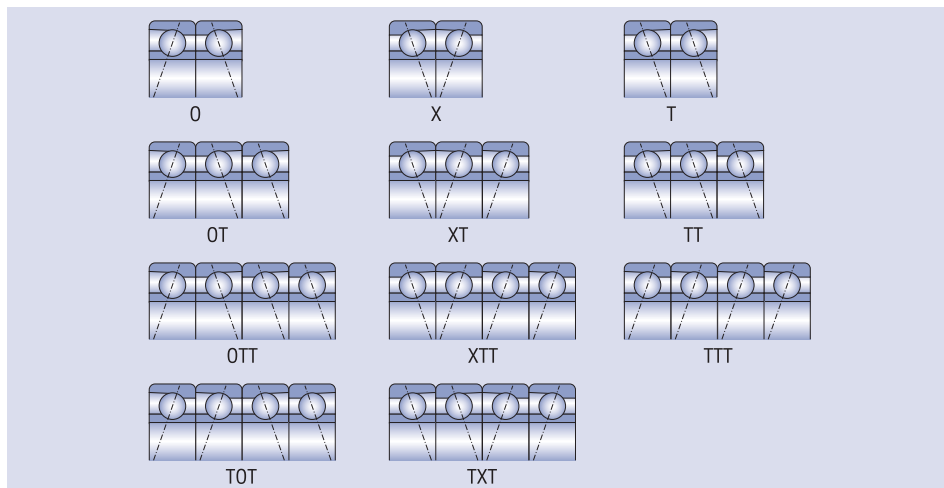

Internal Clearance or Preload Introduced symbols are always used in combination with matching symbols.

A	bearing matching with clearance, e.g. 73050 A
O	bearing matching without clearance, e.g. 7305 P6XO
L	bearing matching with light preload, e.g. B7205CATB P4UL
M	bearing matching with medium preload, e.g. B7204CATB P5XM
S	bearing matching with great preload, e.g. B7304AATB P4OS

Stabilization for Operation at Higher Temperature Both rings have stabilized dimensions for operation at higher temperature

S0	for operating temperature up to 150°C
S1	up to 200°C
S2	up to 250°C
S3	up to 300°C
S4	up to 350°C
S5	up to 400°C

Designation example - NG160 LB C4S3.

Friction Moment (18)

JU	reduced friction moment, e.g. 619/2 JU
JUA	bearings with determined friction moment for starting up, e.g. 623 JUA
JUB	bearings with determined friction moment for running out, e.g. 623 JUB

Grease (19) For designation of bearings with shields or seals on both sides, filled with grease different from the standard one, symbol combinations are used for designation. The first two symbols determine the operating temperature range and the third (a letter) the name or type of lubricant, according to producer's prescription, or another symbol (a digit) determines the grease volume, which the sealed or shielded inner bearing's space is filled with.

TL	grease for low operating temperatures from -60°C to +100°C, designation example 6302-2RS TL
TM	grease for medium operating temperatures from -30°C to +110°C, designation example 6204-2ZR TM
TH	grease for high operating temperatures from -30°C to +200°C, designation example 6202-2Z TH
TW	grease for both low and high operating temperatures from -40°C to +150°C, designation example 6310-2Z C4TW

Note: Symbol TM need not be marked on bearings and packages.

Non-standard PLC bearings PLC A-BC-DE-F designation structure

PLC	symbol for special rolling bearing
A	design group
0	single row ball bearings
1	double row ball bearings
2	thrust ball bearings
3	not occupied
4	single row cylindrical roller, spherical roller and needle roller bearings
5	double and multi-row cylindrical roller, spherical roller and needle roller bearings
6	single, double and four-row tapered roller bearings
7	special double row bearings
8	assembly units and separate parts
9	thrust cylindrical roller, spherical roller, tapered roller and needle roller bearings
BC	dimensional group - two digit symbols
DE	series number in dimensional group - two digit symbols
F	variation of design - one digit symbol

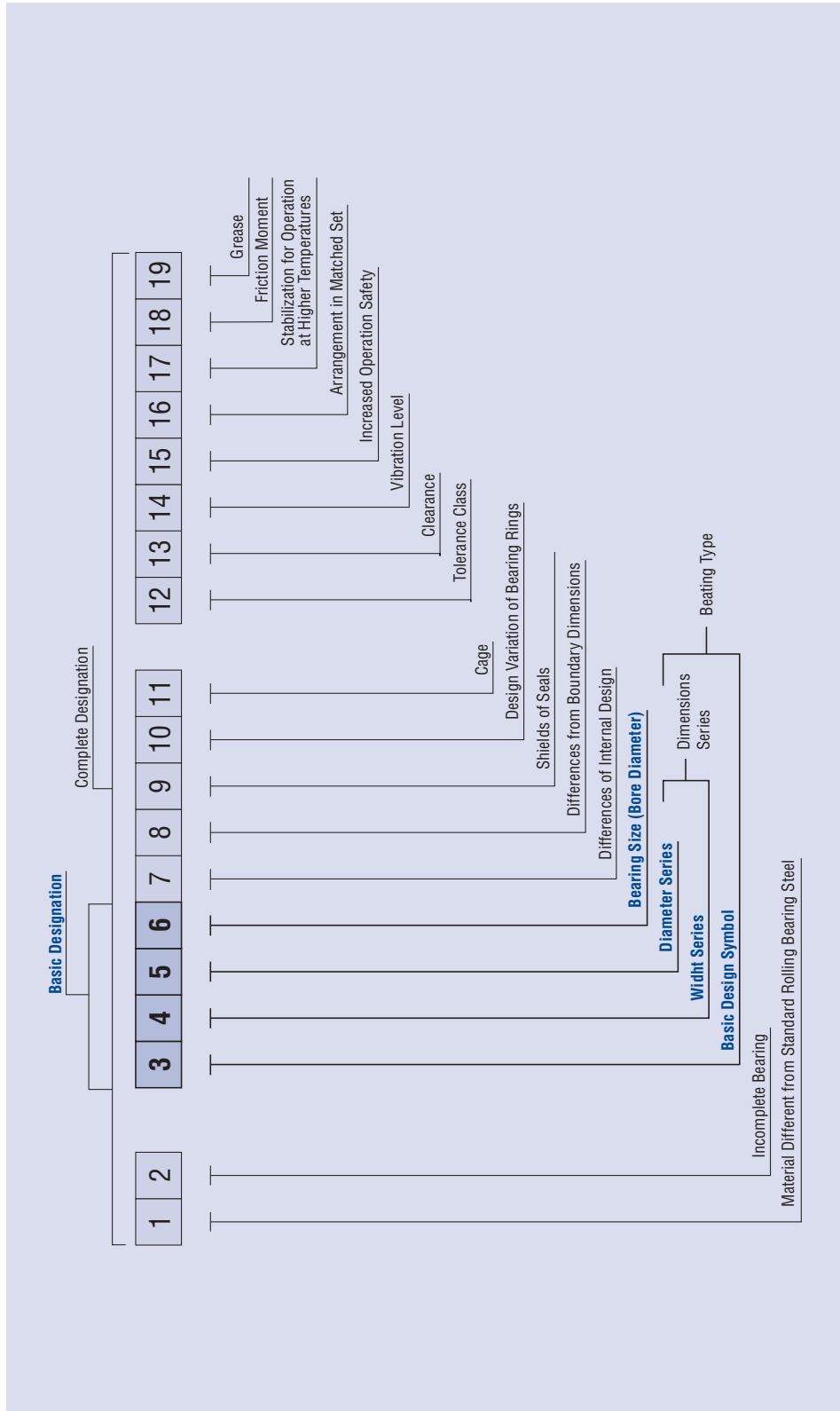

2.3 Tolerance

Under bearing tolerance, dimension and operation accuracy is understood. Bearings are manufactured in tolerance classes P0, P6, P5A, P4, P4A, P2, SP and UP.

Tolerance class P0 is the basic one and a decreasing number in designation means the higher bearing tolerance class. Limiting values for dimension and operation accuracy shown in tables 20 to 30 comply with the standard ISO 492. Designation P5A and P4A are used for bearings manufactured in corresponding tolerance class (P5, P4), or selected parameters are in higher tolerance class than P5 and P4.

Tolerance Symbols and Their Meaning

d	Nominal bore diameter of a cylindrical bore or at the theoretical small end of a tapered bore
d ₁	Nominal diameter at the theoretical large end of a tapered bore
d ₂	Nominal diameter of shaft washer of double direction thrust bearings
Δ _{ds}	Deviation of a two-point size of bore diameter of a cylindrical bore from its nominal size
Δ _{dmp}	Cylindrical bore: deviation of a mid-range size (out of two-point sizes) of bore diameter in any cross-section from its nominal size Tapered bore: deviation of a mid-range size (out of two-point sizes) of bore diameter at the theoretical small end from its nominal size
Δ _{d1mp}	Deviation of a mid-range size (out of twopoint sizes) of bore diameter at the theoretical large end of a tapered bore from its nominal size
Δ _{d2mp}	Mean shaft washer bore diameter deviation of double direction thrust bearings in single radial plane
V _{dp}	Bore diameter variation ; difference between the largest and smallest single bore diameters in one radial plane
V _{dsp}	Range of two-point sizes of bore diameter in any cross-section of a cylindrical or tapered bore
V _{dmp}	Range of mid-range sizes (out of two-point sizes) of bore diameter obtained from any cross-section of a cylindrical bore
V _{d2p}	Shaft washer bore diameter variation of double direction thrust bearings
D	Nominal outside diameter
Δ _{Ds}	Deviation of a two-point size of outside diameter from its nominal size
Δ _{Dmp}	Deviation of a mid-range size (out of twopoint sizes) of outside diameter in any crosssection from its nominal size
V _{Dsp}	Range of two-point sizes of outside diameter in any cross-section
V _{Dp}	Outside diameter variation; difference between the largest and smallest single outsider diameters in one radial plane
V _{Dmp}	Range of mid-range sizes (out of two-point sizes) of outside diameter obtained from any cross-section
B	Nominal ring width
T	Nominal assembled bearing width
T ₁	Nominal effective width of inner subunit assembled with a master outer ring
T ₂	Nominal effective width of outer ring assembled with a master inner subunit
Δ _{Bs}	Symmetrical rings: deviation of a two-point size of inner ring width from its nominal size Asymmetrical rings, upper limit: deviation of a minimum circumscribed size of inner ring width, between two opposite lines, in any longitudinal section which includes the inner ring bore axis, from its nominal size Asymmetrical rings, lower limit: deviation of a two-point size of inner ring width from its nominal size
Δ _{Cs}	Symmetrical rings: deviation of a two-point size of outer ring width from its nominal size Asymmetrical rings, upper limit: deviation of a minimum

circumscribed size of outer ring width, between two opposite lines, in any longitudinal section which includes the outer ring outside surface axis, from its nominal size

Asymmetrical rings, lower limit: deviation of a two-point size of outer ring width from its nominal size

ΔT_s	Deviation of minimum circumscribed size of assembled bearing width from its nominal size
ΔT_{1s}	Deviation of minimum circumscribed size of effective width (inner subunit assembled with a master outer ring) from its nominal size
ΔT_{2s}	Deviation of minimum circumscribed size of effective width (outer ring assembled with a master inner subunit) from its nominal size
C	Nominal ring width
V_{Bs}	Symmetrical rings: range of two-point sizes of inner ring width Asymmetrical rings: range of minimum circumscribed sizes of inner ring width, between two opposite lines, obtained from any longitudinal section which includes the inner ring bore axis
V_{Cs}	Symmetrical rings: range of two-point sizes of outer ring width Asymmetrical rings: range of minimum circumscribed sizes of outer ring width between two opposite lines, obtained from any longitudinal section which includes the outer ring outside surface axis
K_{ia}	Circular radial run-out of inner ring bore surface of assembled bearing with respect to datum, i.e. axis, established from the outer ring outside surface
K_{ea}	Circular radial run-out of outer ring outside surface of assembled bearing with respect to datum, i.e. axis, established from the inner ring bore surface
S_i	Parallelism of inner ring raceway with respect to the face
S_e	Parallelism of outer ring raceway with respect to the face
S_{ia}	Circular axial run-out of inner ring face of assembled bearing with respect to datum, i.e. axis, established from the outer ring outside surface
S_{ea}	Circular axial run-out of outer ring face of assembled bearing with respect to datum, i.e. axis, established from the inner ring bore surface
S_d	Circular axial run-out of inner ring face with respect to datum, i.e. axis, established from the inner ring bore surface
S_D	Perpendicularity of outer ring outside surface axis with respect to datum established from the outer ring face

Dimension and Running Accuracy of Radial Bearings (except Tapered Roller Bearings)

Table 10

Tolerance Class normal

Inner Ring										Limit deviations and tolerance values in micrometers			
d mm		$t_{\Delta dmp}$		t_{Vdsp}			t_{VDmp}	t_{Kia}	$t_{\Delta Bs}$			t_{VBs}	
				Diameter series					All	Normal	Modified ^a		
>	≤	U	L	9	0, 1	2, 3, 4		U	L				
-	0.6	0	-8	10	8	6	6	10	0	-40	-	12	
0.6	2.5	0	-8	10	8	6	6	10	0	-40	-	12	
2.5	10	0	-8	10	8	6	6	10	0	-120	-250	15	
10	18	0	-8	10	8	6	6	10	0	-120	-250	20	
18	30	0	-10	13	10	8	8	13	0	-120	-250	20	
30	50	0	-12	15	12	9	9	15	0	-120	-250	20	
50	80	0	-15	19	19	11	11	20	0	-150	-380	25	
80	120	0	-20	25	25	15	15	25	0	-200	-380	25	
120	180	0	-25	31	31	19	19	30	0	-250	-500	30	
180	250	0	-30	38	38	23	23	40	0	-300	-500	30	
250	315	0	-35	44	44	26	26	so	0	-350	-500	35	
315	400	0	-40	50	50	30	30	60	0	-400	-630	40	
400	500	0	-45	56	56	34	34	65	0	-450	-	50	
500	630	0	-50	63	63	38	38	70	0	-500	-	60	
630	800	0	-75	-	-	-	-	80	0	-750	-	70	
800	1 000	0	-100	-	-	-	-	90	0	-1 000	-	80	
1 000	1 250	0	-125	-	-	-	-	100	0	-1 250	-	100	
1 250	1 600	0	-160	-	-	-	-	120	0	-1 600	-	120	
1 600	2 000	0	-200	-	-	-	-	140	0	-2 000	-	140	

^a Applies to inner rings and outer rings of single bearings made for paired and stack assemblies. Also applies to inner rings with tapered bore with $d \geq 50$ mm.

Dimension and Running Accuracy of Radial Bearings (except Tapered Roller Bearings) Continued table 10

Tolerance Class normal

Outer Ring		Limit deviations and tolerance values in micrometers										
D mm	t _{Δdmp}	t _{vDsp} ^a						t _{vDmp} ^a	t _{Kea}	t _{ΔCs} t _{ΔC1s} ^b		t _{vCs} t _{vC1s} ^b
		Open bearings			Capped bearings					U	L	
		Diameter series										
>	≤	U	L	9	0, 1	2, 3, 4	2, 3, 4	U	L			
-	2.5	0	-8	10	8	6	10	6	15	Identical to t _{ΔBs} and t _{vBs} of an inner ring of the same bearing as the outer ring		
2.5	6	0	-8	10	8	6	10	6	15			
6	18	0	-8	10	8	6	10	6	15			
18	30	0	-9	12	9	7	12	7	15			
30	50	0	-11	14	11	8	16	8	20			
50	80	0	-13	16	13	10	20	10	25			
80	120	0	-15	19	19	11	26	11	35			
120	150	0	-18	23	23	14	30	14	40			
150	150	0	-25	31	31	19	38	19	45			
180	250	0	-30	38	38	23	-	23	50			
250	315	0	-35	44	44	26	-	26	60			
315	400	0	-40	50	50	30	-	30	70			
400	500	0	-45	56	56	34	-	34	80			
500	630	0	-50	63	63	38	-	38	100			
630	800	0	-75	94	94	55	-	55	120			
800	1 000	0	-100	125	125	75	-	75	140			
1 000	1 250	0	-125	-	-	-	-	-	160			
1 250	1 600	0	-160	-	-	-	-	-	190			
1 600	2 000	0	-200	-	-	-	-	-	220			
2 000	2 500	0	-250	-	-	-	-	-	250			

NOTE: The limit deviations for the outside diameter, D₁, of an outer ring flange are given in Table 24

- ^a Applies before mounting and after removal of internal or external snap ring.
- ^b Applies to groove ball bearings only.

Dimension and Running Accuracy of Radial Bearings (except Tapered Roller Bearings)

Table 11

Tolerance Class P6

Inner Ring		Limit deviations and tolerance values in micrometers											
d mm	t _{Δdmp}	t _{vDsp}						t _{vDmp}	t _{Kia}	t _{ΔBs}			t _{vBs}
		Open bearings			Capped bearings					U	Normal	Modified ^a	
		Diameter series											
>	≤	U	L	9	0, 1	2, 3, 4	U	L					
-	0.6	0	-7	9	7	5	5	5	0	-40	-	12	
0.6	2.5	0	-7	9	7	5	5	5	0	-40	-	12	
2.5	10	0	-7	9	7	5	5	6	0	-120	-250	15	
10	18	0	-7	9	7	5	5	7	0	-120	-250	20	
18	30	0	-8	10	8	6	6	8	0	-120	-250	20	
30	50	0	-10	13	10	8	8	10	0	-120	-250	20	
50	80	0	-12	15	15	9	9	10	0	-150	-380	25	
80	120	0	-15	19	19	11	11	13	0	-200	-380	25	
120	180	0	-18	23	23	14	14	18	0	-250	-500	30	
180	250	0	-22	28	28	17	17	20	0	-300	-500	30	
250	315	0	-25	31	31	19	19	25	0	-350	-500	35	
315	400	0	-30	38	38	23	23	30	0	-400	-630	40	
400	500	0	-35	44	44	26	26	35	0	-450	-	45	
500	630	0	-40	50	50	30	30	40	0	-500	-	50	

^a Applies to inner rings and outer rings of single bearings made for paired and stack assemblies. Also applies to inner rings with tapered bore with d ≥ 50 mm.

Outer Ring Limit deviations and tolerance values in micrometers

D mm	t _{ΔDmp}	t _{vDsp} ^a						t _{vDmp} ^a	t _{Kea}	t _{ΔCs} t _{ΔC1s} ^b		t _{vCs} t _{vC1s} ^b
		Open bearings			Capped bearings					U	L	
		Diameter series										
>	≤	U	L	9	0, 1	2, 3, 4	0, 1, 2, 3, 4	U	L			
-	2.5	0	-7	9	7	5	9	5	8	Identical to t _{ΔBs} and t _{vBs} of the same an inner bearing ring of as the outer ring		
2.5	6	0	-7	9	7	5	9	5	8			
6	18	0	-7	9	7	5	9	5	8			
18	30	0	-8	10	8	6	10	6	9			
30	50	0	-9	11	9	7	13	7	10			
50	80	0	-11	14	11	8	16	8	13			
80	120	0	-13	16	16	10	20	10	18			
120	150	0	-15	19	19	11	25	11	20			
150	180	0	-18	23	23	14	30	14	23			
180	250	0	-20	25	25	15	-	15	25			
250	315	0	-25	31	31	19	-	19	30			
315	400	0	-28	35	35	21	-	21	35			
400	500	0	-33	41	41	25	-	25	40			
500	630	0	-38	48	48	29	-	29	50			
630	800	0	-45	56	56	34	-	34	60			
800	1 000	0	-60	75	75	45	-	45	75			

NOTE: The limit deviations for the outside diameter D₁ of an outer ring flange are given in table 24.

- ^a Applies before mounting and after removal of internal or external snap ring.
- ^b Applies to groove ball bearings only.

Dimension and Running Accuracy of Radial Bearings (except Tapered Roller Bearings)

Table 12

Tolerance Class P5

d mm		t _{Δdmp}		t _{Vdsp}		t _{Vdmp}	t _{kia}	t _{sd}	t _{sia} ^a	t _{ΔBs}			t _{vBs}
>	≤	U	L	Diameter series						All	Normal	Modified ^b	
				9	0, 1, 2, 3, 4								
-	0.6	0	-5	5	4	3	4	7	7	0	-40	-250	5
0.6	2.5	0	-5	5	4	3	4	7	7	0	-40	-250	5
2.5	10	0	-5	5	4	3	4	7	7	0	-40	-250	5
10	18	0	-5	5	4	3	4	7	7	0	-80	-250	5
18	30	0	-6	6	5	3	4	8	8	0	-120	-250	5
30	50	0	-8	8	6	4	5	8	8	0	-120	-250	5
50	80	0	-9	9	7	5	5	8	8	0	-150	-250	6
80	120	0	-10	10	8	5	6	9	9	0	-200	-380	7
120	180	0	-13	13	10	7	8	10	10	0	-250	-380	8
180	250	0	-15	15	12	8	10	11	13	0	-300	-500	10
250	315	0	-18	18	14	9	13	13	15	0	-350	-500	13
315	400	0	-23	23	18	12	15	15	20	0	-400	-630	15

^b Applies to groove ball bearings only.
^b Applies to inner rings and outer rings of single bearings made for paired and stack assemblies.
 Also applies to inner rings with tapered bore with d ≥ 50 mm.

D mm		t _{ΔDmp}		t _{VDsp} ^{ab}		t _{Vdmp} ^b	t _{kea}	t _{SD} ^{ce} t _{SD1} ^{de}	t _{Sea} ^{cd}	t _{Sea1} ^d	t _{ΔCs}		t _{vCs} t _{vCs1} ^d
>	≤	U	L	Diameter series							U	L	
				9	0, 1, 2, 3, 4								
-	2.5	0	-5	5	4	3	5	4	8	11	Identical to t _{ΔBs} of an inner of the ring same bearing as the outer ring	5	
2.5	6	0	-5	5	4	3	5	4	8	11		5	
6	18	0	-5	5	4	3	5	4	8	11		5	
18	30	0	-6	6	5	3	6	4	8	11		5	
30	50	0	-7	7	5	4	7	4	8	11		5	
50	80	0	-9	9	7	5	8	4	10	14		6	
80	120	0	-10	10	8	5	10	4.5	11	16		8	
120	150	0	-11	11	8	6	11	5	13	18		8	
150	180	0	-13	13	10	7	13	5	14	20		8	
180	250	0	-15	15	11	8	15	5.5	15	21		10	
250	315	0	-18	18	14	9	18	6.5	18	25		11	
315	400	0	-20	20	15	10	20	6.5	20	28		13	
400	500	0	-23	23	17	12	23	7.5	23	33		15	
500	630	0	-28	28	21	14	25	9	25	35		18	
630	800	0	-35	35	26	18	30	10	30	42		20	

NOTE: The limit deviations for the outside diameter D₁ of an outer ring flange are given in table 24.
^a No values have been established for capped bearings.
^b Applies before mouting and after removal of internal or external snap ring.
^c Does not apply to bearings with flanged outer ring.
^d Applies to groove ball bearings only
^e Tolerance values have become half the values compared to the previous edition of this International Standard because in this edition, SD and SD1 are defined as perpendicularity of outer ring outside surface axis with respect to datum established from the outer ring face back face.

Dimension and Running Accuracy of Radial Bearings (except Tapered Roller Bearings)

Table 13

Tolerance Class P4

d mm		t _{Δdmp} ^a		t _{Vdsp}		t _{Vdmp}	t _{kia}	t _{sd}	t _{sia} ^c	t _{ΔBs}			t _{vBs}
>	≤	U	L	Diameter series						All	Normal	Modified ^d	
				9	0, 1, 2, 3, 4								
-	0.6	0	-4	4	3	2	2.5	3	3	0	-40	-250	2.5
0.6	2.5	0	-4	4	3	2	2.5	3	3	0	-40	-250	2.5
2.5	10	0	-4	4	3	2	2.5	3	3	0	-40	-250	2.5
10	18	0	-4	4	3	2	2.5	3	3	0	-80	-250	2.5
18	30	0	-5	5	4	2.5	3	4	4	0	-120	-250	2.5
30	50	0	-6	6	5	3	4	4	4	0	-120	-250	3
50	80	0	-7	7	5	3.5	4	5	5	0	-150	-250	4
80	120	0	-8	8	6	4	5	5	5	0	-200	-380	4
120	180	0	-10	10	8	5	6	6	7	0	-250	-380	5
180	250	0	-12	12	9	6	8	7	8	0	-300	-500	6

^a These deviations apply to diameter series 9 only.
^b These deviations apply to diameter series 0, 1, 2, 3 and 4 only.
^c Applies to groove ball bearings only.
^d Applies to inner rings and outer rings of single bearings made for paired or stack assemblies.

D mm		t _{ΔDmp} ^a		t _{VDsp} ^{cd}		t _{Vdmp} ^d	t _{kea}	t _{SD} ^{ef} t _{SD1} ^{fg}	t _{Sea} ^{eg}	t _{Sea1} ^g	t _{ΔCs}		t _{vCs} t _{vCs1} ^g
>	≤	U	L	Diameter series							U	L	
				9	0, 1, 2, 3, 4								
-	2.5	0	-4	4	3	2	3	2	5	7	Identical to t _{ΔBs} of an inner ring of the bearing same as the outer ring	2.5	
2.5	6	0	-4	4	3	2	3	2	5	7		2.5	
6	18	0	-4	4	3	2	3	2	5	7		2.5	
18	30	0	-5	5	4	2.5	4	2	5	7		2.5	
30	50	0	-6	6	5	3	5	2	5	7		2.5	
50	80	0	-7	7	5	3.5	5	2	5	7		3	
80	120	0	-8	8	6	4	6	2.5	6	8		4	
120	150	0	-9	9	7	5	7	2.5	7	10		5	
150	180	0	-10	10	8	5	8	2.5	8	11		5	
180	250	0	-11	11	8	6	10	3.5	10	14		7	
250	315	0	-13	13	10	7	11	4	10	14		7	
315	400	0	-15	15	11	8	13	5	13	18		8	

NOTE: The limit deviations for the outside diameter, D₁, of an outer ring flange are given in table 24.
^a These deviations apply to diameter series 9 only.
^b These deviations apply to diameter series 0, 1, 2, 3 and 4 only.
^c No values have been established for capped bearings.
^d Applies before mouting and after removal of internal or external snap ring.
^e Does not apply to bearings with flanged outer ring.
^f Tolerance values have become half the values compared to the previous edition of this International Standard because in this edition, SD and SD1 are defined as perpendicularity of outer ring outside surface axis with respect to datum established from the outer ring face back face.
^g Applies to groove ball bearings only.

Dimension and Running Accuracy of Radial Bearings (except Tapered Roller Bearings)

Table 14

Tolerance Class 2

d mm		t _{Δdmp} ^a t _{Δds} ^b		t _{Vdsp}	t _{Vdmp}	t _{Kia}	t _{Sd}	t _{Sia} ^c	t _{ΔBs}			t _{VBs}
>	≤	U	L						All	Normal	Modified	
									U	L		
-	0.6	0	-2.5	2.5	1.5	1.5	1.5	1.5	0	-40	-250	1.5
0.6	2.5	0	-2.5	2.5	1.5	1.5	1.5	1.5	0	-40	-250	1.5
2.5	10	0	-2.5	2.5	1.5	1.5	1.5	1.5	0	-40	-250	1.5
10	18	0	-2.5	2.5	1.5	1.5	1.5	1.5	0	-80	-250	1.5
18	30	0	-2.5	2.5	1.5	2.5	1.5	2.5	0	-120	-250	1.5
30	50	0	-2.5	2.5	1.5	2.5	1.5	2.5	0	-120	-250	1.5
50	80	0	-4	4	2	2.5	1.5	2.5	0	-150	-250	1.5
80	120	0	-5	5	2.5	2.5	2.5	2.5	0	-200	-380	2.5
120	150	0	-7	7	3.5	2.5	2.5	2.5	0	-250	-380	2.5
150	180	0	-7	7	3.5	5	4	5	0	-250	-380	4
180	250	0	-8	8	4	5	5	5	0	-300	-500	5

^a Applies to diameter series 9 only.
^b Applies to diameter series 0, 1, 2, 3 and 4 only.
^c Applies to groove ball bearings only.
^d Applies to inner rings and outer rings of single bearings made for paired or stack assemblies.

D mm		t _{ΔDmp} ^a t _{ΔDs} ^b		t _{Vdsp} ^{cd}	t _{Vdmp} ^d	t _{Kea}	t _{SD} ^{ef} t _{SD1} ^{fg}	t _{Sea} ^{gg}	t _{Sea1} ^g	t _{ΔCs} t _{ΔC1s} ^g		t _{Vcs} t _{Vc1s} ^g
>	≤	U	L							U	L	
-	2.5	0	-2.5	2.5	1.5	1.5	0.75	1.5	3			1.5
2.5	6	0	-2.5	2.5	1.5	1.5	0.75	1.5	3			1.5
6	18	0	-2.5	2.5	1.5	1.5	0.75	1.5	3			1.5
18	30	0	-4	4	2	2.5	0.75	2.5	4			1.5
30	50	0	-4	4	2	2.5	0.75	2.5	4			1.5
50	80	0	-4	4	2	4	0.75	4	6			1.5
80	120	0	-5	5	2.5	5	1.25	5	7			2.5
120	150	0	-5	5	2.5	5	1.25	5	7			2.5
150	180	0	-7	7	3.5	5	1.25	5	7			2.5
180	250	0	-8	8	4	7	2	7	10			4
250	315	0	-8	8	4	7	2.5	7	10			5
315	400	0	-10	10	5	8	3.5	8	11			7

NOTE: The limit deviations for the outside diameter, D₁, of an outer ring flange are given in table 24.
^a These deviations apply to diameter series 9 only.
^b These deviations apply to diameter series 0, 1, 2, 3 and 4 only.
^c No values have been established for capped bearings.
^d Applies before mounting and after removal of internal or external snap ring.
^e Does not apply to bearings with flanged outer ring.
^f Tolerance values have become half the values compared to the previous edition of this International Standard because in this edition, SD and SD1 are defined as perpendicularity of outer ring outside surface axis with respect to datum established from the outer ring face back face.
^g Applies to groove ball bearings only.

Dimension and Running Accuracy of Tapered Roller Bearings

Table 15

Tolerance Class normal

d mm		t _{Δdmp}		t _{Vdsp}	t _{Vdmp}	t _{Kia}
>	≤	U	L			
-	10	0	-12	12	9	15
10	18	0	-12	12	9	15
18	30	0	-12	12	9	18
30	50	0	-12	12	9	20
50	80	0	-15	15	11	25
80	120	0	-20	20	15	30
120	180	0	-25	25	19	35
180	250	0	-30	30	23	50
250	315	0	-35	35	26	60
315	400	0	-40	40	30	70
400	500	0	-45	45	34	80
500	630	0	-60	60	40	90
630	800	0	-75	75	45	100
800	1 000	0	-100	100	55	115
1 000	1 250	0	-125	125	65	130
1 250	1 600	0	-160	160	80	150
1 600	2 000	0	-200	200	100	170

D mm		t _{ΔDmp}		t _{Vdsp}	t _{Vdmp}	t _{Kea}
>	<	U	L			
-	18	0	-12	12	9	18
18	30	0	-12	12	9	18
30	50	0	-14	14	11	20
50	80	0	-16	16	12	25
80	120	0	-18	18	14	35
120	150	0	-20	20	15	40
150	180	0	-25	25	19	45
180	250	0	-30	30	23	50
250	315	0	-35	35	26	60
315	400	0	-40	40	30	70
400	500	0	-45	45	34	80
500	630	0	-50	60	38	100
630	800	0	-75	80	55	120
800	1 000	0	-100	100	75	140
1 000	1 250	0	-125	130	90	160
1 250	1 600	0	-160	170	100	180
1 600	2 000	0	-200	210	110	200
2 000	2 500	0	-250	265	120	220

NOTE: The limit deviations for the outside diameter, D₁, of an outer ring flange are given in table 24.

Dimension and Running Accuracy of Tapered Roller Bearings

Table 16

Tolerance Class normal

Width - inner ring, outer ring, single row rolling bearings and single row bearing half assemblies

Limit deviations and tolerance values in micrometers											
d mm		t _{ABs}		t _{ACs}		t _{ATs} t _{ATFs}		t _{AT1s}		t _{AT2s} t _{ATF2s}	
>	≤	U	L	U	L	U	L	U	L	U	L
-	10	0	-120	0	-120	+200	0	+100	0	+100	0
10	18	0	120	0	-120	+200	0	100	0	+100	0
18	30	0	-120	0	-120	+200	0	-100	0	+100	0
30	50	0	-120	0	-120	+200	0	-100	0	+100	0
50	80	0	-150	0	-150	+200	0	-100	0	+100	0
80	120	0	-200	0	-200	+200	-200	-100	-100	+100	-100
120	180	0	250	0	-250	1350	-250	150	150	+200	-100
180	250	0	-300	0	-300	+350	-250	-150	-150	+200	-100
250	315	0	-350	0	-350	+350	-250	-150	-150	+200	-100
315	400	0	400	0	-400	+400	-400	200	200	+200	-200
400	500	0	-450	0	-450	+150	-450	+225	-225	+225	-225
500	630	0	-500	0	-500	+500	-500	-	-	-	-
630	800	0	-750	0	-750	+600	-600	-	-	-	-
800	1000	0	-1000	0	-1000	+750	-750	-	-	-	-
1000	1250	0	-1250	0	-1250	+900	-900	-	-	-	-
1250	1600	0	-1600	0	-1600	+1050	-1050	-	-	-	-
1600	2000	0	-2000	0	-2000	+1200	-1200	-	-	-	-

Dimension and Running Accuracy of Tapered Roller Bearings

Table 17

Tolerance Class 6X

Width - inner ring, outer ring, single row rolling bearings and single row bearing half assemblies

Limit deviations and tolerance values in micrometers											
d mm		t _{ABs}		t _{ACs}		t _{ATs} t _{ATFs}		t _{AT1s}		t _{AT2s} t _{ATF2s}	
>	≤	U	L	U	L	U	L	U	L	U	L
-	10	0	-50	0	-100	+100	0	+50	0	+50	0
10	18	0	-50	0	-100	+100	0	+50	0	+50	0
18	30	0	-50	0	-100	+100	0	+50	0	+50	0
30	50	0	-50	0	-100	+100	0	+50	0	+50	0
50	80	0	-50	0	-100	+100	0	+50	0	+50	0
80	120	0	-50	0	-100	+100	0	+50	0	+50	0
120	180	0	-50	0	-100	+150	0	+50	0	+100	0
180	250	0	-50	0	-100	+150	0	+50	0	+100	0
250	315	0	-50	0	-100	+200	0	+100	0	+100	0
315	400	0	-50	0	-100	+200	0	+100	0	+100	0
400	500	0	-50	0	-100	+200	0	+100	0	+100	0

The diameter tolerances and radial run-out for inner and outer rings of this tolerance class are the same as those given in Table 15 for the normal class.

Dimension and Running Accuracy of Tapered Roller Bearings

Table 18

Tolerance Class 5

Inner Ring Limit deviations and tolerance values in micrometers

d mm		t _{Δdmp}		t _{Vdsp}	t _{Vdmp}	t _{Kia}	t _{sd}
>	≤	U	L				
-	10	0	-7	5	5	5	7
10	18	0	-7	5	5	5	7
18	30	0	-8	6	5	5	8
30	50	0	-10	8	5	6	8
50	80	0	-12	9	6	7	8
80	120	0	-15	11	0	0	9
120	180	0	-18	14	2	11	10
180	250	0	-22	17	11	13	11
250	315	0	-25	19	13	13	13
315	400	0	-30	23	15	15	15
400	500	0	-35	28	17	20	17
500	630	0	-40	35	20	25	20
630	800	0	-50	45	25	30	25
800	1000	0	-60	60	30	37	30
1000	1250	0	-75	75	37	45	40
1250	1600	0	-90	90	45	55	50

Outer Ring Limit deviations and tolerance values in micrometers

D mm		t _{ΔDmp}		t _{VDsp}	t _{VDmp}	t _{Kea}	t _{SD} ^{ab} t _{SD1} ^b
>	≤	U	L				
-	18	0	-8	6	5	6	4
18	30	0	-8	6	5	6	4
30	50	0	-9	7	5	7	4
50	80	0	-11	8	6	8	4
80	120	0	-13	10	7	10	4.5
120	150	0	-15	11	8	11	5
150	180	0	-18	14	9	13	5
180	250	0	-20	15	10	15	5.5
250	315	0	-25	19	13	18	6.5
315	400	0	-28	22	14	20	6.5
400	500	0	-33	26	17	24	8.5
500	630	0	-38	30	20	30	10
630	800	0	-45	38	25	36	12.5
800	1000	0	-60	50	30	43	15
1000	1250	0	-80	65	38	52	19
1250	1600	0	-100	90	50	62	25
1600	2000	0	-125	120	65	73	32.5

NOTE: The limit deviations for the outside diameter, D₁, of an outer ring flange are given in table 24.

^a Does not apply to bearings with flanged outer ring.

^b Tolerance values have become half the values compared to the previous edition of this International Standard because in this edition, SD and SD1 are defined as perpendicularity of outer ring outside surface axis with respect to datum established from the outer ring face back face.

Dimension and Running Accuracy of Tapered Roller Bearings

Table 19

Tolerance Class 5

Width - inner ring, outer ring, single row rolling bearings and single row bearing half assemblies

Limit deviations and tolerance values in micrometers											
d mm		t _{ABs}		t _{ACs}		t _{ATs} t _{ATFs}		t _{AT1s}		t _{AT2s} t _{ATF2s}	
>	≤	U	L	U	L	U	L	U	L	U	L
-	10	0	-200	0	-200	+200	-200	+100	-100	+100	-100
10	18	0	-200	0	-200	+200	-200	+100	-100	+100	-100
18	30	0	-200	0	-200	+200	-200	+100	-100	+100	-100
30	50	0	-240	0	-240	+200	-200	+100	-100	+100	-100
50	80	0	-300	0	-300	+200	-200	+100	-100	+100	-100
80	120	0	-400	0	-400	+200	-200	+100	-100	+100	-100
120	180	0	-500	0	-500	+350	-250	+150	-150	+200	-100
180	250	0	-600	0	-600	+350	-250	+150	-150	+200	-100
250	315	0	-700	0	-700	+350	-250	+150	-150	+200	-100
315	400	0	-800	0	-800	+400	-400	+200	-200	+200	-200
400	500	0	-900	0	-900	+450	-450	+225	-225	+225	-225
500	630	0	-1 100	0	100	+500	-500	-	-	-	-
630	800	0	-1 600	0	-1 600	+600	-600	-	-	-	-
800	1 000	0	-2 000	0	-2 000	+750	-750	-	-	-	-
1 000	1 250	0	-2 000	0	-2 000	+750	-750	-	-	-	-
1 250	1 600	0	-2 000	0	-2 000	+900	-900	-	-	-	-

Dimension and Running Accuracy of Tapered Roller Bearings

Table 20

Tolerance Class 4

Inner Ring Limit deviations and tolerance values in micrometers

d mm		t _{Ads}		t _{Vdsp}	t _{Vdmp}	t _{Kia}	t _{Sd}	t _{Sia}
>	≤	U	L					
-	10	0	-5	4	4	3	3	3
10	18	0	-5	4	4	3	3	3
18	30	0	-6	5	4	3	4	4
30	50	0	-8	6	5	4	4	4
50	80	0	-9	7	5	4	5	4
80	120	0	-10	8	5	5	5	5
120	180	0	-13	10	7	6	6	7
180	250	0	-15	11	8	8	7	8
250	315	0	-18	12	9	9	8	9

Outer Ring Limit deviations and tolerance values in micrometers

D mm		t _{ADs}		t _{VDsp}	t _{VDmp}	t _{Kea}	t _{SD} ^{ab} t _{SD1} ^b	t _{Sea} ^a	t _{Sea1}
>	≤	U	L						
-	18	0	-6	5	4	4	2	5	7
18	30	0	-6	5	4	4	2	5	7
30	50	0	-7	5	5	5	2	5	7
50	80	0	-9	7	5	5	2	5	7
80	120	0	-10	8	5	6	2.5	6	8
120	150	0	-11	8	6	7	2.5	7	10
150	180	0	-13	10	7	8	2.5	8	11
180	250	0	-15	11	8	10	3.5	10	14
250	315	0	-18	14	9	11	4	10	14
315	400	0	-20	15	10	13	5	13	18

NOTE: The limit deviations for the outside diameter, D₁, of an outer ring flange are given in table 24.

^a Does not apply to bearings with flanged outer ring.

^b Tolerance values have become half the values compared to the previous edition of this International Standard because in this edition, SD and SD1 are defined as perpendicularity of outer ring outside surface axis with respect to datum established from the outer ring face back face.

Dimension and Running Accuracy of Tapered Roller Bearings

Table 21

Tolerance Class 4

Width - inner ring, outer ring, single row rolling bearings and single row bearing half assemblies

Limit deviations and tolerance values in micrometers											
d mm		t _{ABs}		t _{ACs}		t _{ATs} t _{ATFs}		t _{AT1s}		t _{AT2s} t _{ATF2s}	
>	≤	U	L	U	L	U	L	U	L	U	L
-	10	0	-200	0	-200	+200	-200	+100	-100	+100	-100
10	18	0	-200	0	-200	+200	-200	+100	-100	+100	-100
18	30	0	-200	0	-200	+200	-200	+100	-100	+100	-100
30	50	0	-240	0	-240	+200	-200	+100	-100	+100	-100
50	80	0	-300	0	-300	+200	-200	+100	-100	+100	-100
80	120	0	-400	0	-400	+200	-200	+100	-100	+100	-100
120	180	0	-500	0	-500	+350	-250	+150	-150	+200	-100
180	250	0	-600	0	-600	+350	-250	+150	-150	+200	-100
250	315	0	-700	0	-700	+350	-250	+150	-150	+200	-100

Dimension and Running Accuracy of Tapered Roller Bearings

Table 22

Tolerance Class 2

Inner Ring Limit deviations and tolerance values in micrometers

d mm		t _{Ads}		t _{Vdsp}	t _{Vdmp}	t _{Kia}	t _{Sd}	t _{S1a}
>	≤	U	L					
-	10	0	-4	2.5	1.5	2	1.5	2
10	18	0	-4	2.5	1.5	2	1.5	2
18	30	0	-4	2.5	1.5	2.5	1.5	2.5
30	50	0	-5	3	2	2.5	2	2.5
50	80	0	-5	4	2	3	2	3
80	120	0	-6	5	2.5	3	2.5	3
120	180	0	-7	7	3.5	4	3.5	4
180	250	0	-8	7	4	5	5	5
250	315	0	-8	8	5	6	5.5	6

Outer Ring Limit deviations and tolerance values in micrometers

D mm		t _{ADs}		t _{VDsp}	t _{VDmp}	t _{Kea}	t _{SD} ^{ab} t _{SD1} ^b	t _{Sea} ^a	t _{Sea1}
>	<	U	L						
-	18	0	-5	4	2.5	2.5	0.75	2.5	4
18	30	0	-5	4	2.5	2.5	0.75	2.5	4
30	50	0	-5	4	2.5	2.5	1	2.5	4
50	80	0	-6	4	2.5	4	1.25	4	6
80	120	0	-6	5	3	5	1.5	5	7
120	150	0	-7	5	3.5	5	1.75	5	7
150	180	0	-7	7	4	5	2	5	7
180	250	0	-8	8	5	7	2.5	7	10
250	315	0	-9	8	5	7	3	7	10
315	400	0	-10	10	6	8	3.5	8	11

NOTE: The limit deviations for the outside diameter D1, of an outer ring flange are given in table 24.

^a Does not apply to bearings with flanged outer ring.

^b Tolerance values have become half the values compared to the previous edition of this International Standard because in this edition, SD and SD1 are defined as perpendicularity of outer ring outside surface axis with respect to datum established from the outer ring face back face.

Dimension and Running Accuracy of Tapered Roller Bearings

Table 23

Tolerance Class 2

Width - inner ring, outer ring, single row rolling bearings and single row bearing half assemblies

Limit deviations and tolerance values in micrometers

d mm		t _{ABs}		t _{ACs}		t _{ATs} t _{ATFs}		t _{AT1s}		t _{AT2s} t _{ATF2s}	
>	≤	U	L	U	L	U	L	U	L	U	L
-	10	0	-200	0	-200	+200	-200	+100	-100	+100	-100
10	18	0	-200	0	-200	+200	-200	+100	-100	+100	-100
18	30	0	-200	0	-200	+200	-200	+100	-100	+100	-100
30	50	0	-240	0	-240	+200	-200	+100	-100	+100	-100
50	80	0	-300	0	-300	+200	-200	+100	-100	+100	-100
80	120	0	-400	0	-400	+200	-200	+100	-100	+100	-100
120	180	0	-500	0	-500	+200	-250	+100	-100	+100	-150
180	250	0	-600	0	-600	+200	-300	+100	-150	+100	-150
250	315	0	-700	0	-700	+200	-300	+100	-150	+100	-150

Radial bearings, flange on the outer ring

Table 24

Limit deviations of the outer diameter of the flange

Limit deviations and tolerance values in micrometers

D ₁ mm		t _{AD1s}			
		Locating flange		Non-locating flange	
>	≤	U	L	U	L
-	6	0	-36	+220	-36
6	10	0	-36	+220	-36
10	18	0	-43	+270	-43
18	30	0	-52	+330	-52
30	50	0	-62	+390	-62
50	80	0	-74	+460	-74
80	120	0	-87	+540	-87
120	180	0	-100	+630	-100
180	250	0	-115	+720	-115
250	315	0	-130	+810	-130
315	400	0	-140	+890	-140
400	500	0	-155	+970	-155
500	630	0	-175	+1 100	-175
630	800	0	-200	+1 250	-200
800	1 000	0	-230	+1 400	-230
1 000	1 250	0	-260	+1 650	-260
1 250	1 600	0	-310	+1 950	-310
1 600	2 000	0	-370	+2 300	-370
2 000	2 500	0	-440	+2 800	-440

Taper hole, taper 1:12 and 1:30

Table 25

Tolerances for taper holes, for normal Tolerance Class, are specified in Tables 25 and 26.

Taper hole tolerances include:

- t_{Δdmp},
- conicity tolerance, determined by the tolerances for the inclination of the cone t_{ΔSL},
- tv_{dsp}.

NOTE: See Figure 9.

Limit deviations and tolerance values in micrometers

d mm		t _{Δdmp}		t _{ΔSL}		tv _{dsp} ^{ab}
>	≤	U	L	U	L	
-	10	+22	0	+15	0	9
10	18	+27	0	+18	0	11
18	30	+33	0	+21	0	13
30	50	+39	0	+25	0	16
50	80	+46	0	+30	0	19
80	120	+54	0	+35	0	22
120	180	+63	0	+40	0	40
180	250	+72	0	+46	0	46
250	315	+81	0	+52	0	52
315	400	+89	0	+57	0	57
400	500	+97	0	+63	0	63
500	630	+110	0	+70	0	70
630	800	+125	0	+80	0	-
800	1 000	+140	0	+90	0	-
1 000	1 250	+165	0	+105	0	-
1 250	1 600	+195	0	+125	0	-

^a Applies in any cross-section of the bore.

^b Does not apply to diameter series 7 and 8.

Taper hole, taper 1:30

Table 26

Limit deviations and tolerance values in micrometers

d mm		t _{Δdmp}		t _{ΔSL}		tv _{dsp} ^{ab}
>	≤	U	L	U	L	
-	50	+15	0	+30	0	19
50	80	+15	0	+30	0	19
80	120	+20	0	+35	0	22
120	180	+25	0	+40	0	40
180	250	+30	0	+46	0	46
250	315	+35	0	+52	0	52
315	400	+40	0	+57	0	57
400	500	+45	0	+63	0	63
500	630	+50	0	+70	0	70

^a Applies in any cross-section of the bore.

^b Does not apply to diameter series 7 and 8.

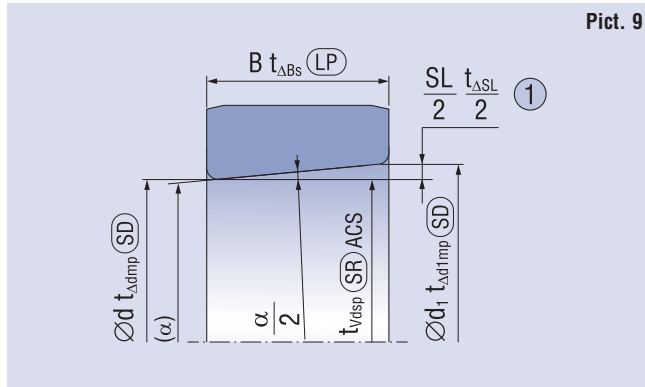

Pict. 9

①

SL is a calculated nominal size from d and d_1 , i.e. $SL = (d_1 - d) = 2B \tan(\alpha/2)$;
 ΔSL is a calculated characteristic, i.e. $\Delta SL = \Delta d_{1mp} - \Delta d_{mp}$

2.4 Internal Clearance

Bearing clearance is the value of one bearing displacement length of assembled bearing with respect to the other ring from one end position to the other one. The displacement can be in radial direction (radial clearance) or axial (axial clearance).

In a mounted bearing smaller radial clearance can be found than the same bearing had before mounting. Radial clearance reduction is caused by interference of the bearing rings on the shaft and in housing bore and thus it is dependent on selected tolerance of bearing seating surface diameters.

Another change of radial clearance, mainly its reduction, arises during operation from temperatures evoked by its own operation and surrounding sources, but also by elastic deformations caused by load.

Clearance for standard designed bearings is determined so that one of the bearing rings can be fixed, what is sufficient for most operation conditions in the arrangement. For special arrangements with different requirement on the radial clearance bearings with various radial clearance designated C1 up to C5 are produced.

Values for various internal clearances according to the standard ISO 5753-1 are shown for individual bearing types in tables 27 up to 32 and these values are valid for non-mounted bearings by zero measuring load.

For double row angular contact ball bearings instead of radial clearance the axial clearance measured at axial load 100 N is introduced.

Single row angular contact ball bearings and single row tapered roller bearings are usually mounted in pairs and the radial or axial clearance is adjusted during mounting.

Radial Clearance of Single Row Ball Bearings

Table 27

Bore Diameter		Radial Clearance									
d		C2		normal		C3		C4		C5	
over	to	min	max	min	max	min	max	min	max	min	max
mm	mm	μm									
2.5	10	0	7	2	13	8	23	14	29	20	37
10	18	0	9	3	18	11	25	18	33	25	45
18	24	0	10	5	20	13	28	20	36	28	48
24	30	1	11	5	20	13	28	23	41	30	53
30	40	1	11	6	20	15	33	28	46	40	64
40	50	1	11	6	23	18	36	30	51	45	73
50	65	1	15	8	28	23	43	38	61	55	90
65	80	1	15	10	30	25	51	46	71	65	105
80	100	1	18	12	36	30	58	53	84	75	120
100	120	2	20	15	41	36	66	61	97	90	140
120	140	2	23	18	48	41	81	71	114	105	160
140	160	2	23	18	53	46	91	81	130	120	180
160	180	2	25	20	61	53	102	91	147	135	200
180	200	2	30	25	71	63	117	107	163	150	215

Axial Clearance of Double Row Angular Contact Ball Bearings

Table 28

Bore Diameter		Axial Clearance							
d		C2		normal		C3		C4	
over	to	min	max	min	max	min	max	min	max
mm	mm	μm							
6	10	1	11	5	21	12	28	25	45
10	18	1	12	6	23	13	31	27	47
18	24	2	14	7	25	16	34	28	48
24	30	2	15	8	27	18	37	30	50
30	40	2	16	9	29	21	40	33	54
40	50	2	19	11	33	23	44	36	58
50	65	3	22	13	36	26	48	40	63
65	80	3	24	15	40	30	54	46	71

Radial Clearance of Double Row Self-Aligning Ball Bearing

Table 29

Bore Diameter		Cylindrical Bore Radial Clearance										Tapered Bore Radial Clearance									
d		C2		normal		C3		C4		C5		C2		normal		C3		C4		C5	
over	to	min	max	min	max	min	max	min	max	min	max	min	max	min	max	min	max	min	max	min	max
mm		µm																			
2.5	6	1	8	5	15	10	20	15	25	21	33	-	-	-	-	-	-	-	-	-	-
6	10	2	9	6	17	12	25	19	33	27	42	-	-	-	-	-	-	-	-	-	-
10	14	2	10	6	19	13	26	21	35	30	48	-	-	-	-	-	-	-	-	-	-
14	18	3	12	8	21	15	28	23	37	32	50	-	-	-	-	-	-	-	-	-	-
18	24	4	14	10	23	18	30	25	39	34	52	7	17	13	26	20	33	28	42	37	55
24	30	5	16	11	24	19	35	29	46	40	58	9	20	15	28	23	39	33	50	44	62
30	40	6	18	13	29	23	40	34	53	46	66	12	24	19	35	29	46	40	59	52	72
40	50	6	19	14	31	25	44	37	57	50	71	14	27	22	39	33	52	45	65	58	79
50	65	7	21	16	36	30	50	45	69	62	88	18	32	27	47	41	61	56	80	73	99
65	80	8	24	18	40	35	60	54	83	76	108	23	39	35	57	50	75	69	98	91	123
80	100	9	27	22	48	42	70	64	96	89	124	29	47	42	68	62	90	84	116	109	144
100	120	10	31	25	56	50	83	75	114	105	145	35	56	50	81	75	108	100	139	130	170
120	140	10	38	30	68	60	100	90	135	125	175	-	-	-	-	-	-	-	-	-	-
140	160	15	44	35	80	70	120	110	161	150	210	-	-	-	-	-	-	-	-	-	-

Radial Clearance of Single Row Cylindrical Roller Bearings

Table 30

Bore Diameter		Radial Clearance									
d		C2		normal		C3		C4		C5	
over	to	min	max	min	max	min	max	min	max	min	max
mm		µm									
10	24	0	25	20	45	35	60	50	75	65	90
24	30	0	25	20	45	35	60	50	75	70	95
30	40	5	30	25	50	45	70	60	85	80	105
40	50	5	35	30	60	50	80	70	100	95	125
50	65	10	40	40	70	60	90	80	110	110	140
65	80	10	45	40	75	65	100	90	125	130	165
80	100	15	50	50	85	75	110	105	140	155	190
100	120	15	55	50	90	85	125	125	165	180	220
120	140	15	60	60	105	100	145	145	190	200	245
140	160	20	70	70	120	115	165	165	215	225	275
160	180	25	75	75	125	120	170	170	220	250	300
180	200	35	90	90	145	140	195	195	250	275	330
200	225	45	105	105	165	160	220	220	280	305	365
225	250	45	110	110	175	170	235	235	300	330	395
250	280	55	125	125	195	190	260	260	330	370	440
280	315	55	130	130	205	200	275	275	350	410	485
315	355	65	145	145	225	225	305	305	385	455	535
355	400	100	190	190	280	280	370	370	460	510	600
400	450	110	210	210	310	310	410	410	510	565	665
450	500	110	220	220	330	330	440	440	550	625	735

Radial Clearance of Double Row Cylindrical Roller Bearings with Tapered Bore Bearing with Non-Interchangeable Rings Determined for Machine Tool Spindles

Table 31

Bore Diameter		Radial Clearance				Bore Diameter		Radial Clearance			
d		C1NA		C2NA		d		C1NA		C2NA	
over	to	min	max	min	max	over	to	min	max	min	max
mm		µm									
24	30	15	25	25	35	160	180	55	85	75	110
30	40	15	25	25	40	180	200	60	90	80	120
40	50	17	30	30	45	200	225	60	95	90	135
50	65	20	35	35	50	225	250	65	100	100	150
65	80	25	40	40	60	250	280	75	110	110	165
80	100	35	55	45	70	280	315	80	120	120	180
100	120	40	60	50	80	315	355	90	135	135	200
120	140	45	70	60	90	355	400	100	150	150	225
140	160	50	75	65	100	400	450	110	170	170	255

Radial Clearance of Single Row Needle Roller Bearings with Interchangeable Rings

Table 32

Bore Diameter		Radial Clearance			
d		normal		C3	
over	to	min	max	min	max
mm		µm			
10	14	10	50	25	70
14	18	15	55	35	75
18	24	25	65	40	80
24	30	30	65	50	80
30	40	40	75	60	95
40	50	40	85	65	100
50	65	45	90	70	120
65	80	50	110	75	135
80	100	60	115	95	150
100	120	70	125	115	70
120	140	80	155	130	205
140	160	80	160	140	210

2.5 Cages

Cage in the rolling bearing fulfills the following roles

- separates rolling elements evenly around the periphery
- prevents contact of rolling elements and their sliding
- prevents falling out of the rolling elements from separable or self-aligning bearings when mounting.

From the point of view of design and material the cages are divided into pressed and machined.

Pressed cages are made of steel or brass sheet and are mostly used in dimensionally smaller and medium bearings. Their advantage in comparison with the solid cages is the smaller weight. Machined cages are made of steel, brass, bronze, light metals or plastic in various designs. Cages made of metals are used when there are higher demands on the cage rigidity and the bearing is determined for higher operational temperatures. Cages are radially centered on the rolling elements in bearings, this is the most usual way, or they are centered on the rib of either of the bearing rings.

Bearings without cages, i.e. with full complement of rolling elements, are only rarely used, namely only for some bearing types, e.g. single row needle roller bearings.

In the texts about individual bearing types the survey of cages in standard design and delivery possibilities of bearings with cages of non-standard design are given in the section Cages.

2.6 Shields and Seals

Bearings with sealing on one or both sides are manufactured with shields (Z, 2Z, ZR, 2ZR) or seals (RS, 2RS, RSR, 2RSR).

Shields form a non-contact sealing. In design Z and 2Z the fitting for the shield is in the inner ring, in design ZR and 2ZR the shield adheres on the smooth rib of the bearing inner ring.

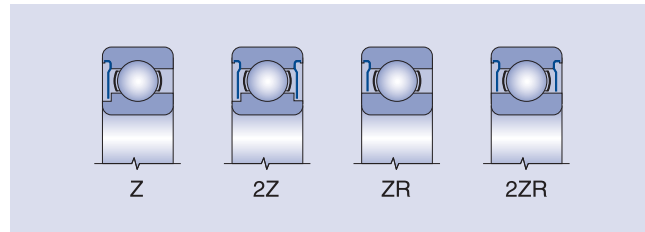

Sealing is created by sealing rings made of rubber vulcanized on sheet steel reinforcement, which create an effective contact sealing with a chamfered fitting on the inner ring (RS, 2RS) as well as in design with contact on the smooth rib of the inner ring (RSR, 2RSR).

Seals and sealing rings are fastened in the grooves of the outer ring and are unseparable.

Sealing RS, 2RS, RSR, 2RSR can be used for temperature range -30°C to +110°C, sealing RS1, -2RS1, RSR1 and -2RSR1 for temperature range -45°C to +120°C, sealing RS2, -2RS2, RSR2, -RSR2 for temperature range -60°C to +180°C.

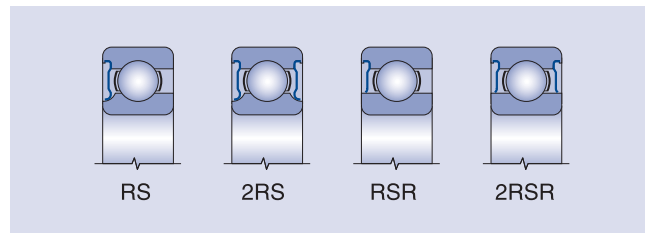

Bearings with sealings on both sides in standard design are filled with grease of a temperature range from -30°C to 110°C, whose qualities secure lubrication usually during the whole bearing life at normal operational conditions. Bearings in this design cannot be relubricated.

3. Bearing Arrangement Design

3.1 General Principles of Rolling Bearing Arrangement Design

Rotating shaft or another component arranged in rolling bearings is guided by them in radial as well as in axial direction so that the basic condition, the movement uniqueness, can be fulfilled. The component should be, as far as possible, statically determined, i.e. supported in two points radially and in one point axially.

A typical example of such an arrangement is in Pict. 9, where the shaft is radially guided in two bearings, one of which secures it in axial direction. The locating bearing carries the radial load and simultaneously also the axial load in both directions. Radial bearings that can accommodate combined load are mostly used as locating bearings, which carry, e.g. single row ball bearings, double row angular contact ball bearings, double row self-aligning ball bearings, double row spherical roller bearings or single row angular contact ball bearings and tapered roller bearings. The two last mentioned bearing types must be mounted in pairs. The non-locating bearing carries only radial load and must permit certain displacement of the shaft in axial direction so that arising of non-desired axial preload caused by environment (temperature dilatations, production inaccuracies of connecting arrangement components, etc.) can be hindered.

Axial displacement can be secured by displacement between one bearing ring and a machine part, which is directly connected with the bearing, e.g. between outer bearing ring and housing bore (Pict. 10a) or directly in the bearing (Pict.10b).

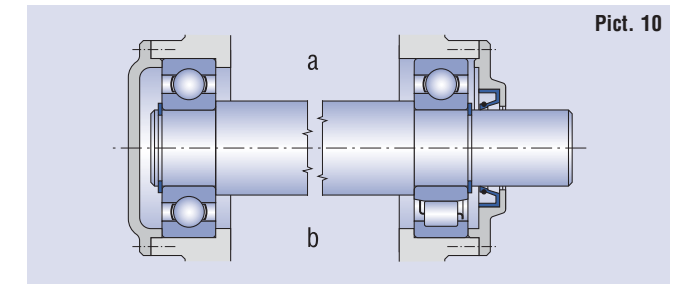

Arrangements, in which greater radial and axial loads act by higher rotational speed, should be set up so that the bearing can accommodate only radial or axial forces, see Pict. 11. In these cases it is possible to use for radial guidance some of the radial bearings and for axial guidance those radial bearings which are also able to carry axial load or a pair of these bearings, or double direction thrust bearing, or a pair of single direction thrust bearings. There is a condition where the axially locating thrust bearing should be arranged with radial clearance.

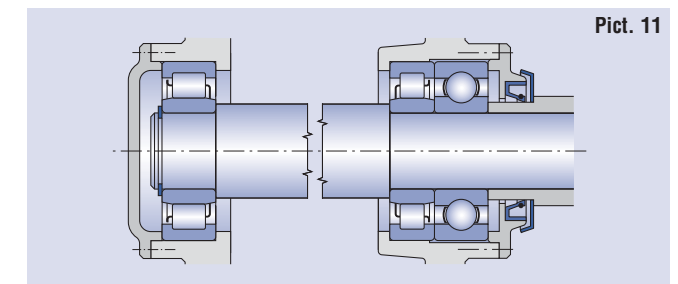

Another, often used solution is the arrangement of two bearings, whose design enables the accommodation both radial and axial loads. Both bearings accommodate alternately the axial load, always according to direction of force acting, and simultaneously they carry also the radial load. An example of this arrangement is shown in Pict. 12.

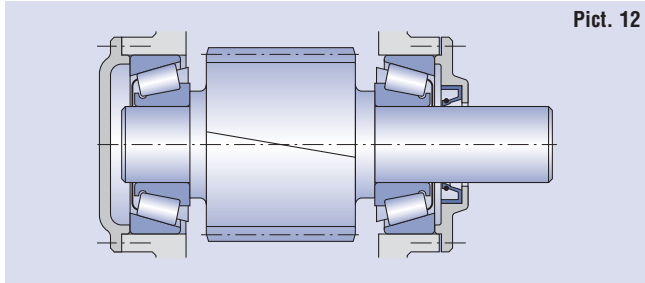

Pict. 12

As a verified design the pair of single row tapered roller bearings or single row angular contact ball bearings are used. There can be used other bearing types which are able to carry the load both in radial and axial direction simultaneously, e.g. separable single row ball bearings or single row cylindrical roller bearings in NJ design, etc.

3.2 Bearing Location

Radial and axial bearing location on the shaft and in the housing bore or another part has a direct connection with the whole arrangement design. When selecting the way of location, the character and acting forces magnitude, the operating temperature in the arrangement and material of mating parts must be taken into account.

Mounting, dismounting and maintenance methods must be taken into consideration when designing mating parts dimensions.

3.2.1 Radial Location of Bearing

The bearing is located in radial direction on the mating cylindrical shaft and housing bore surface. In some cases, adapter or withdrawal sleeves are used by mounting on the shaft, or the bearing can be mounted directly on the tapered shaft.

The correct radial location of the bearing on the shaft significantly influences utilization of its load rating and correct function in arrangement. The following viewpoints are important:

- a) safe location and uniform supporting of bearings
- b) simple mounting and dismounting
- c) displacement of non-locating bearing in axial direction

Basically, both bearing rings should be mounted in tight fits, because only in this way their reliable supporting around the whole periphery and radial fixing against turning can be achieved. To make mounting and dismounting easier or for moving the non-locating ring, a loose fit of one of the rings is permissible.

When selecting correct radial bearing location, following influences must be taken into account.

Circumferential Load

occurs if the respective bearing ring rotates and the load direction is not changed or if the ring rotates and the load does not rotate. The bearing ring periphery is gradually loaded during one revolution. In this case the loaded bearing ring must be always fitted with necessary interference fit.

Point Load

occurs when the bearing ring does not rotate and the external force is constantly directed into the same ring raceway point or if the ring and load rotate at the same rotating speed. The ring subjected to point load can be mounted with loose fit, if the conditions require it.

Indeterminate Load

occurs if the ring is subjected to varying external forces at which directions and load changes cannot be determined (e.g. unbalanced mass, shocks, etc.). Under these conditions in most applications bearings with greater radial clearance should be used.

Load Magnitude

directly influences selection of the interference fit (higher load - larger interference), especially in cases of impact loads. A firm fitting on the shaft or in the housing causes ring deformation, and as a result reduction of radial clearance

arises. To secure the necessary radial clearance in the firm arrangement, it is necessary to use bearings with greater radial clearance. Resulting clearance after mounting depends on the bearing type and its dimension.

Bearing Size and Type

determines the size of necessary interference fit of the fitted ring. For smaller sized bearings smaller interference fits are selected, and vice versa. Relatively smaller interferences are used, e.g. for the same sizes of ball bearings in comparison with the cylindrical roller, tapered roller or spherical roller bearings.

Material and Design of Mating Components

must be taken into account when determining their production tolerance. Results of practical experience are shown in the following tables. In cases where bearings are mounted into housings made of light metal alloys or on journals of hollow shafts, arrangements with higher interference are selected. Split housings are not suitable for arrangements with higher interferences, because there is danger of the bearing pinching in the dividing plane.

Heating generating

in the bearing can cause loosening of the interference on the journal and turning of the ring. In the housing a converse case can come into being. The heating causes clearance decreasing and subsequently limiting and even stopping of the axial displacement of the non-locating bearing ring. That is why we pay a great deal of attention to this fact when designing an arrangement.

Fitting Accuracy

from the point of view of its tolerances and geometric shapes is important because it can be transmitted towards the bearing ring raceways and defines the arrangement accuracy.

When using bearings with normal tolerance class, the tolerance of journal seating surface IT6 is selected, and for housing seating surface tolerance IT7.

For smaller dimensioned ball and cylindrical roller bearings it is possible to use for the journal tolerance IT5 and housing bore IT6.

For bearings in higher tolerance classes, for arrangements with high requirements on accuracy, e.g. spindles of machine tools, the least tolerance class IT5 is recommended for the shaft and for housing IT6.

Permissible ovality and conicity deviation and permissible lateral bearing runout of supporting surfaces must be in reference to axis smaller than the diameter tolerance of the journal and bore.

With higher bearing tolerance class also requirements on the seating surface accuracy increase. Recommended values are shown in tables 33 and 34.

Recommended Shape Accuracies of Bearing Seating Fits Table 33

Bearing Tolerance Class	Fitting Location	Permissible Ovality Deviation	Permissible Lateral Runout of Carrying Surfaces in Reference to Axis
P0, P6	shaft	$\frac{IT5}{2}$	IT3
	housing	$\frac{IT6}{2}$	IT4
P5, P4	shaft	$\frac{IT3}{2}$	IT2
	housing	$\frac{IT3}{2}$	IT3

Standard Tolerances IT2 to IT6

Table 34

Nominal Diameter over mm	to mm	Tolerance Class				
		IT2	IT3	IT4	IT5	IT6
		µm				
6	10	1.5	2.5	4	6	9
10	18	2	3	5	8	11
18	30	2.5	4	6	9	13
30	50	2.5	4	7	11	16
50	80	3	5	8	13	19
80	120	4	6	10	15	22
120	180	5	8	12	18	25
180	250	7	10	14	20	29
250	315	8	12	16	23	32
315	400	9	13	18	25	36
400	500	10	15	20	27	40

Mounting and Dismounting bearings

if one of the rings is arranged with a loose fit it is simple. If, because of operational reasons, it is necessary to arrange both of the rings with an interference, a suitable bearing type should be selected, e.g. a separable bearing (tapered roller, cylindrical roller, needle roller bearing) or a bearing with tapered bore. Journals for sleeve arrangements of bearings with tapered bore can be in tolerance class h9 or h10, geometric shape should be in tolerance class IT5 or IT7 according to arrangement requirements.

Axial Displacement of Non-Locating Bearing Rings

must be secured by all operation conditions. When using a non-separable bearing, displacement of the stationary loaded ring is reached by its fitting with clearance (moveable).

In light metal alloy housings it is necessary, if the outer ring is fitted with clearance, to put a steel bush in the bore.

A reliable displacibility in axial direction is reached by using cylindrical roller bearing type N and NU or radial needle bearing.

Recommended journal and bore diameter tolerances of the mating components for radial and thrust bearings are shown in tables 35 to 40.

3.2.2 Axial Securing of Bearing

Inner bearing ring with cylindrical bore arranged on the journal with interference fit (fixed) is usually secured in the axial direction by means of a locknut, end-plate or snap ring, when the other face is usually supported by the shaft shoulder. Surrounding parts are used as abutment faces for inner rings, and if necessary, spacing rings are inserted between this component and bearing inner ring. Examples of axial bearing securing are shown in Pict.13.

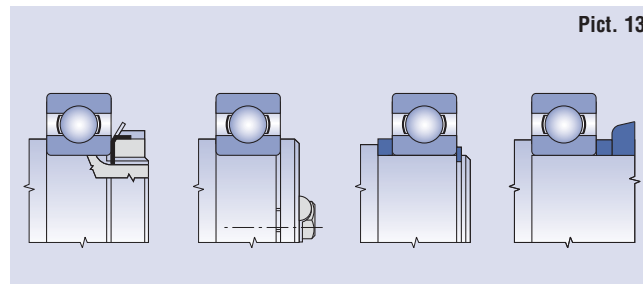

Radial Bearing Shaft Diameter Tolerances (Valid for Solid Steel Shafts)

Table 35

Operating Conditions	Arrangement Examples	Journal Diameter [mm]			Tolerance
		Ball Bearings	Cylindrical, Needle ¹⁾ Tapered Roller Bearings	Spherical Roller Bearings	
Inner Ring Point Load					
Light and Normal Load $P_r \leq 0,15 C_r$	Free wheels, sheaves, belt pulleys	All Diameters			g6 ²⁾
Heavy Impact Load $P_r > 0,15 C_r$	Industrial truck wheels, tension pulleys				h6
Inner Ring Circumferential Load or Indeterminate Load					
Light and Variable Load $P_r \leq 0,07 C_r$	transport equipments, ventilators	(18) to 100 (100) to 200	≤ 40 (40) to 140	- -	j6 k6
Normal and Heavy Load $P_r > 0,07 C_r$	General engineering, electric motors, turbines, pumps, combustion motors, gear boxes, woodworking machines	≤ 18 (18) to 100 (100) to 140 (140) to 200	- ≤ 40 (40) to 100 (100) to 140 (140) to 200 > 200	- - ≤ 40 (40) to 65 (65) to 100 (100) to 140 >140	j5 k5 (k6) ³⁾ m5 (m6) ³⁾ m6 n6 p6
Extremely Heavy Load, Impacts, Complicated Operating Conditions $P_r > 0,15 C_r$	Axle bearings for railway vehicles, traction motors, rolling mills	- - -	(50) to 140 (140) to 500 > 500	(50) to 100 (100) to 500 > 500	n6 ⁴⁾ p6 ⁴⁾ r6 (p6) ⁴⁾
High Arrangement Accuracy under Light Load $P_r \leq 0,07 C_r$	Machine tools	≤ 18 (18) to 100 (100) to 200	- ≤ 40 (40) to 140 (140) to 200	- - -	h5 ⁵⁾ j5 ⁵⁾ k5 ⁵⁾ m5
Exclusively Axial Load		All Diameters			j6
Bearings with Tapered Bore and Adapter or Withdrawal Sleeve					
All Kinds of Load	General arrangements, axle bearings	All Diameters			h9/IT5
	for railway vehicles. Not complicated arrangements				h10/IT7

¹⁾ Tolerances for needle roller bearings without rings.
²⁾ Tolerance f6 can be selected for securing axial displacibility
³⁾ Tolerances in brackets are selected usually for single row tapered roller bearings or at low rotational speeds where tolerance dispersion is not significant
⁴⁾ It is necessary to use bearings with higher radial clearance than normal
⁵⁾ Tolerances for single row ball bearings in tolerance classes P5 and P4 are shown on page 32 and 33 .

**Housing Bore Diameter Tolerances for Radial Bearings
(Valid for Steel, Cast and Cast Steel Housings)**

Table 36

Operating Conditions	Displacibility of Outer Ring	Housing	Arrangement Examples	Tolerance
Outer Ring Circumferential Load				
Heavy Impact Load $P_r > 0.15 C_r$ Thin Walled Housings	not displacable	one-part	Wheel hubs with cylindrical roller bearings, big end bearings	P7
Normal and Heavy Load $P_r > 0.07 C_r$	not displacable		Wheel hubs with ball bearings, crane travel wheels, crankshaft bearings	N7
Light and Variable Load $P_r \leq 0.07 C_r$	not displacable		Conveyor rollers, tension pulleys	M7
Indeterminate Load				
Heavy Impact Load $P_r > 0.15 C_r$	not displacable	one-part	Traction motors	M7
Heavy and Normal Load $P_r > 0.07 C_r$	As a rule, not displacable		Electric motors, pumps, crankshafts	K7
Light and Varying Load $P_r \leq 0.07 C_r$	As a rule, displacable		Electric motors, pumps, ventilators, crankshafts	J7
Accurate Arrangement				
Light Load $P_r \leq 0.07 C_r$	As a rule, not displacable	one-part	Cylindrical roller bearings for machine tools ball bearings for	K6 ¹⁾
	Displacable		machine tools.	J6 ²⁾
	Easily displacable		Small electric motors	H6
Outer Ring Point Load				
Any Load	Easily displacable	one-part or two-part	General engineering, axle bearings of railway vehicles	H7 ³⁾
Light and Normal Load $P_r \leq 0.15 C_r$			General engineering, less complicated engineering	H8
			Drying rollers of paperworking machines, big electric motors	G7 ⁴⁾

¹⁾ For heavy loads tighter tolerances are selected - M6 or N6. For cylindrical roller bearings with tapered bore tolerances K5 or M5.
²⁾ Tolerances for single row ball bearings in tolerances P5 and P4 - see page 32 and 33.
³⁾ For bearings with outer diameter $D < 250$ mm, with temperature difference between outer ring and housing over 10°C, tolerance G7 is selected
⁴⁾ For bearings with outer diameter $D > 250$ mm, with temperature difference between outer ring and housing over 10°C, tolerance F7 is selected

Journal Diameter Tolerance for Thrust Bearings

Table 37

Bearing Type	Load	Journal Diameter	Tolerance
		[mm]	
Thrust Ball Bearings	Exclusively Axial Load	All Diameters	j6
			j6
Diameters Thrust Spherical Roller Bearings	Simultaneously Axial and Radial Loads	All Diameters	Stationary Load of Shaft Washer or Indeterminate Load
			Rotating Load of Shaft Washer

Housing Bore Diameter Tolerances for Thrust Bearings

Table 38

Bearing Type	Load	Note	Tolerance
Thrust Ball Bearings arrangements housing	Exclusively Axial Load	In common washer can have clearance	H8
		Housing washer mounted with radial clearance	-
Thrust Spherical Roller Bearings	Simultaneously Axial and Radial Load	Stationary Load or Indeterminate Load of Housing Washer	H7
		Rotating Load of Housing Washer	M7

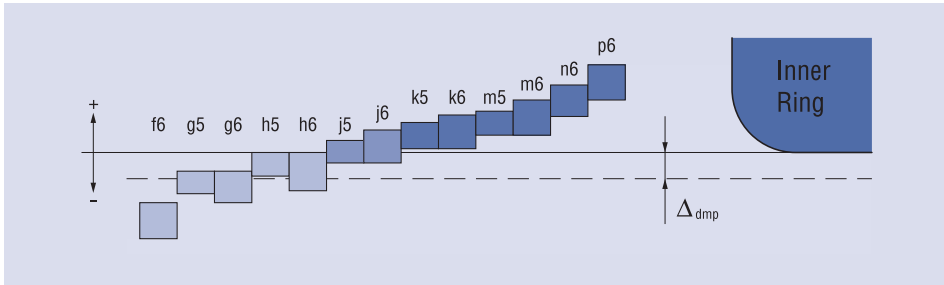

Journal Diameter Tolerance Limiting Deviations

Table 39

Journal Nominal Diameter over to mm	f6		g5		g6		h5		h6		j5		j6(Js6)		k5		
	upper	lower	upper	lower	upper	lower	upper	lower	upper	lower	upper	lower	upper	lower	upper	lower	
μm																	
1	3	-6	-12	-2	-6	-2	-8	0	-4	0	-6	+2	-2	+4	-2	+4	0
3	6	-10	-18	-4	-9	-4	-12	0	-5	0	-8	+3	-2	+6	-2	+6	+1
6	10	-13	-22	-5	-11	-5	-14	0	-6	0	-9	+4	-2	+7	-2	+7	+1
10	18	-16	-27	-6	-14	-6	-17	0	-8	0	-11	+5	-3	+8	-3	+9	+1
18	30	-20	-33	-7	-16	-7	-20	0	-9	0	-13	+5	-4	+9	-4	+11	+2
30	50	-25	-41	-9	-20	-9	-25	0	-11	0	-16	+6	-5	+11	-5	+13	+2
50	80	-30	-49	-10	-23	-10	-29	0	-13	0	-19	+6	-7	+12	-7	+15	+2
80	120	-36	-58	-12	-27	-12	-34	0	-15	0	-22	+6	-9	+13	-9	+18	+3
120	180	-43	-68	-14	-32	-14	-39	0	-18	0	-25	+7	-11	+14	-11	+21	+3
180	250	-50	-79	-15	-35	-15	-44	0	-20	0	-29	+7	-13	+16	-13	+24	+4
250	315	-56	-88	-17	-40	-17	-49	0	-23	0	-32	+7	-16	+16	-16	+27	+4
315	400	-62	-98	-18	-43	-18	-54	0	-25	0	-36	+7	-18	+18	-18	+29	+4
400	500	-68	-108	-20	-47	-20	-60	0	-27	0	-40	+7	-20	+20	-20	+32	+5
500	630	-76	-120	-	-	-22	-66	-	-	0	-44	-	-	+22	-22	-	-
630	800	-80	-130	-	-	-24	-74	-	-	0	-50	-	-	+25	-25	-	-
800	1000	-86	-142	-	-	-26	-82	-	-	0	-56	-	-	+28	-28	-	-
1000	1250	-98	-164	-	-	-28	-94	-	-	0	-66	-	-	+33	-33	-	-

Journal Nominal Diameter over to mm	k6		m5		m6		n6		p6		h9 ¹⁾		IT5		h10 ¹⁾ IT7		
	upper	lower	upper	lower	upper	lower	upper	lower	upper	lower	upper	lower	upper	lower	upper	lower	
μm																	
1	3	+6	0	+6	+2	+8	+2	+10	+4	+12	+6	0	-25	4	0	-40	10
3	6	+9	+1	+9	+4	+12	+4	+16	+8	+20	+12	0	-30	5	0	-48	12
6	10	+10	+1	+12	+6	+15	+6	+19	+10	+24	+15	0	-36	6	0	-58	15
10	18	+12	+1	+15	+7	+18	+7	+23	+12	+29	+18	0	-43	8	0	-70	18
18	30	+15	+2	+17	+8	+21	+8	+28	+15	+35	+22	0	-52	9	0	-84	21
30	50	+18	+2	+20	+9	+25	+9	+33	+17	+42	+26	0	-62	11	0	-100	25
50	80	+21	+2	+24	+11	+30	+11	+39	+20	+51	+32	0	-74	13	0	-120	30
80	120	+25	+3	+28	+13	+35	+13	+45	+23	+59	+37	0	-87	15	0	-140	35
120	180	+28	+3	+33	+15	+40	+15	+52	+27	+68	+43	0	-100	18	0	-160	40
180	250	+33	+4	+37	+17	+46	+17	+60	+31	+79	+50	0	-115	20	0	-185	46
250	315	+36	+4	+43	+20	+52	+20	+66	+34	+88	+56	0	-130	23	0	-210	52
315	400	+40	+4	+46	+21	+57	+21	+73	+37	+98	+62	0	-140	25	0	-230	57
400	500	+45	+5	+50	+23	+63	+23	+80	+40	+108	+68	0	-155	27	0	-250	63
500	630	+44	0	-	-	+70	+26	+88	+44	+122	+78	0	-175	30	0	-280	70
630	800	+50	0	-	-	+80	+30	+100	+50	+138	+88	0	-200	35	0	-320	80
800	1000	+56	0	-	-	+90	+34	+112	+56	+156	+100	0	-230	40	0	-360	90
1000	1250	+66	0	-	-	+106	+40	+132	+66	+186	+120	0	-260	46	0	-420	105

¹⁾ For journals made in tolerance h9 and H10 for bearings with adapter or withdrawal sleeves deviations of roundness and cylindricity must not exceed basic tolerances IT5 and IT7

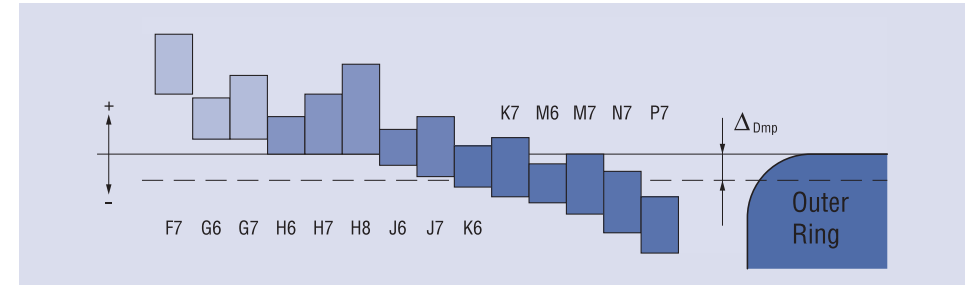

Bore Diameter Tolerance Limiting Deviations

Table 40

Bore Nominal Diameter over to mm	F7		G6		G7		H6		H7		H8		J6(Js6)		
	upper	lower	upper	lower	upper	lower	upper	lower	upper	lower	upper	lower	upper	lower	
μm															
6	10	+28	+13	+14	+5	+20	+5	+9	0	+15	0	+22	0	+5	-4
10	18	+34	+16	+17	+6	+24	+6	+11	0	+18	0	+27	0	+6	-5
18	30	+41	+20	+20	+7	+28	+7	+13	0	+21	0	+33	0	+8	-5
30	50	+50	+25	+25	+9	+34	+9	+16	0	+25	0	+39	0	+10	-6
50	80	+60	+30	+29	+10	+40	+10	+19	0	+30	0	+46	0	+13	-6
80	120	+71	+36	+34	+12	+47	+12	+22	0	+35	0	+54	0	+16	-6
120	180	+83	+43	+39	+14	+54	+14	+25	0	+40	0	+63	0	+18	-7
180	250	+96	+50	+44	+15	+61	+15	+29	0	+46	0	+72	0	+22	-7
250	315	+108	+56	+49	+17	+69	+17	+32	0	+52	0	+81	0	+25	-7
315	400	+119	+62	+54	+18	+75	+18	+36	0	+57	0	+89	0	+29	-7
400	500	+131	+68	+60	+20	+83	+20	+40	0	+63	0	+97	0	+33	-7
500	630	+146	+76	+66	+22	+92	+22	+44	0	+70	0	+110	0	+22	-22
630	800	+160	+80	+74	+24	+104	+24	+50	0	+80	0	+125	0	+25	-25
800	1000	+176	+86	+82	+26	+116	+26	+56	0	+90	0	+140	0	+28	-28
1000	1250	+203	+98	+94	+28	+133	+28	+66	0	+105	0	+165	0	+33	-33
1250	1600	+235	+110	+108	+30	+155	+30	+78	0	+125	0	+195	0	+39	-39

Bore Nominal Diameter over to mm	J7(Js7)		K6		K7		M6		M7		N7		P7		
	upper	lower	upper	lower	upper	lower	upper	lower	upper	lower	upper	lower	upper	lower	
μm															
6	10	+8	-7	+2	-7	+5	-10	-3	-12	0	-15	-4	-19	-9	-24
10	18	+10	-8	+2	-9	+6	-12	-4	-15	0	-18	-5	-23	-11	-29
18	30	+12	-9	+2	-11	+6	-15	-4	-17	0	-21	-7	-28	-14	-35
30	50	+14	-11	+3	-13	+7	-18	-4	-20	0	-25	-8	-33	-17	-42
50	80	+18	-12	+4	-15	+9	-21	-5	-24	0	-30	-9	-39	-21	-51
80	120	+22	-13	+4	-18	+10	-25	-6	-28	0	-35	-10	-45	-24	-59
120	180	+25	-14	+4	-21	+12	-28	-8	-33	0	-40	-12	-52	-28	-68
180	250	+30	-16	+5	-24	+13	-33	-8	-37	0	-46	-14	-60	-33	-79
250	315	+36	-16	+5	-27	+16	-36	-9	-41	0	-52	-14	-66	-36	-88
315	400	+39	-18	+7	-29	+17	-40	-10	-46	0	-57	-16	-73	-41	-98
400	500	+43	-20	+8	-32	+18	-45	-10	-50	0	-63	-17	-80	-45	-108
500	630	+35	-35	0	-44	0	-70	-26	-70	-26	-96	-44	-114	-78	-148
630	800	+40	-40	0	-50	0	-80	-30	-80	-30	-110	-50	-130	-88	-168
800	1000	+45	-45	0	-56	0	-90	-34	-90	-34	-124	-56	-146	-100	-190
1000	1250	+52	-52	0	-66	0	-105	-40	-106	-40	-145	-66	-171	-120	-225
1250	1600	+62	-62	0	-78	0	-125	-48	-126	-48	-173	-78	-203	-140	-265

Examples of axial locating of bearings with tapered bore seated directly on the tapered journal or by means of an adapter or withdrawal sleeve are in Pict. 14.

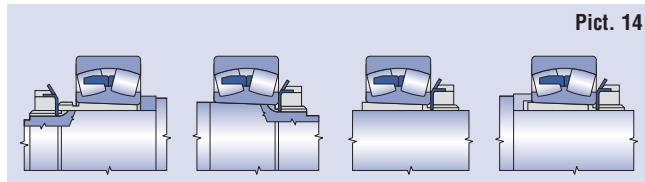

Permissible bearing axial load fixed by an adapter sleeve on smooth shafts without bearing resting on the shaft shoulder is calculated according to equation:

$$F_a = 3Bd$$

F_a	- permissible bearing axial load	[N]
B	- bearing width	[mm]
d	- bearing bore diameter	[mm]

If the axial displacement of the outer ring in the housing is not required, then we can use solution, when the face supporting or seating surface of the bearing cover, nut or snap ring are used. Bearings with grooves for snap ring (NR) do not require much space and their securing is simple. Examples - see Pict. 15.

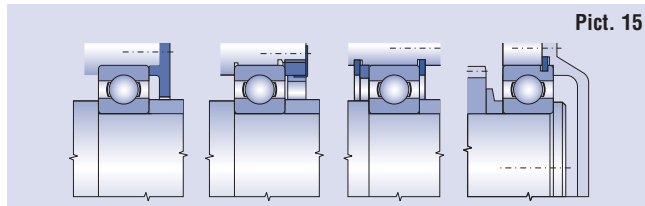

Abutment dimensions for each bearing shown in this publication are in the dimension tables.

3.3 Sealing

Sealing of the bearing space is very important, because damaging materials which can be found in the bearing environment influence it and often can cause its breakdown. Sealing also has an opposite function - it prevents the lubricant leaking out of the bearing and arrangement space. That is why sealing must always be designed with regard to operating conditions of machines or equipments, arrangement design, lubricating method, maintenance possibility and economic questions concerning production and utilization.

3.3.1 Non-Contact Sealing

Between non-rotating and rotating parts there is only a narrow gap when using this sealing. It is filled with grease. Using this sealing, wear of components from friction does not occur and that is why this sealing can be used for the highest rotational speeds and for high operating temperatures. Examples of a gap sealing are in Pict. 16.

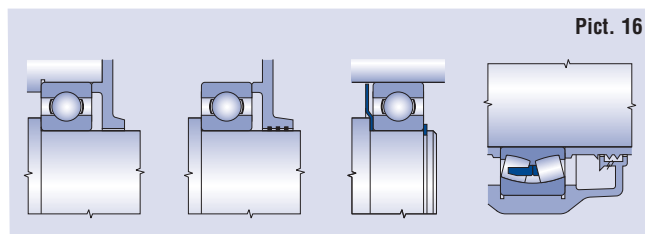

Another very effective sealing is the labyrinth sealing which can improve the sealing effect by a greater number of labyrinths or prolongation of sealing gaps. Examples - see Pict. 17.

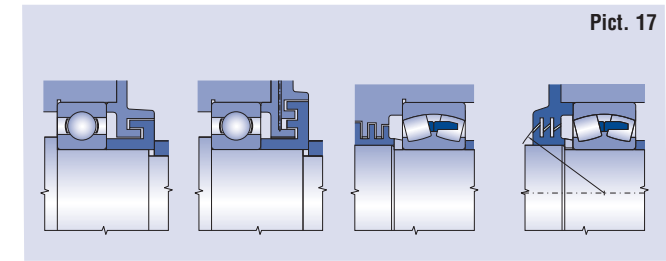

3.3.2 Rubber Sealing

Rubbing sealing is created of elastic or soft, but sufficiently impermeable material, which is inserted between the rotating and firm part. Such a sealing is usually cheap and is suitable for various designs. The disadvantage is the sliding friction of the contacting surfaces, and therefore there is limited utilization for high rotational speeds.

Sealing with a felt ring is the simplest (Pict. 18). It is suitable for operating temperature -40° to $+160^{\circ}\text{C}$ and for peripheral speeds to $7 \text{ m}\cdot\text{s}^{-1}$ and sliding surface roughness max. $R_a = 0,16$, hardness min. 45 HRC or hard chromium plating. Dimensions of the felt rings are given by corresponding national standards.

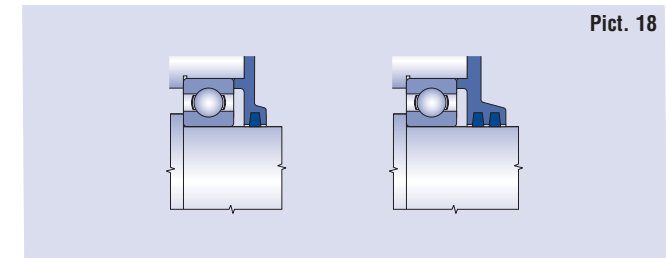

A very wide-spread way of sealing is sealing with shaft washers (Pict. 19). Radial shaft seal washers are made of rubber or other suitable plastic reinforced by steel sheet reinforcement. According to the material used they are suitable for operating temperature from -30° to $+160^{\circ}\text{C}$. Permissible peripheral speed depends on sliding surface roughness:

- to $2 \text{ m}\cdot\text{s}^{-1}$ is roughness max. $R_a = 0.8$
- to $4 \text{ m}\cdot\text{s}^{-1}$ is roughness max. $R_a = 0.4$
- to $12 \text{ m}\cdot\text{s}^{-1}$ is roughness max. $R_a = 0.2$

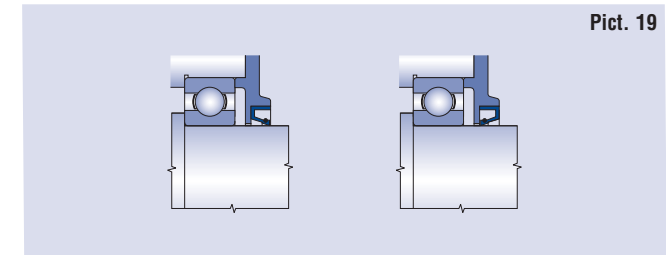

Except for mentioned most commonly used sealing rings there are rubbing sealing designs which use the just formed sealing rings made of rubber, plastic, etc., or special spring rings. This sealing is chosen either for applications with high requirements on bearing space sealing (great environment pollution, high temperature, chemical substance influence), or for economic reasons by mass or series production. Examples - see Pict. 20.

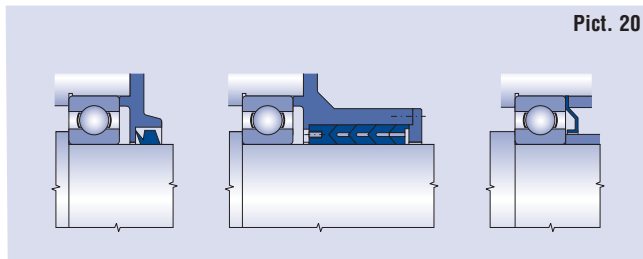

Pict. 20

3.3.3 Combined Sealing

Increase sealing effect can be reached by non-contact and rubbing sealing combination. Such a sealing is recommended for wet and polluted environment. Example - see Pict. 21.

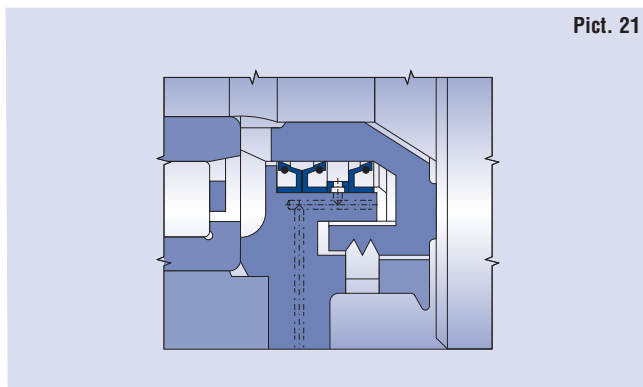

Pict. 21

4. Bearing Lubrication

The correct bearing lubrication has a direct influence on the bearing life. Lubricant creates between the rolling element and bearing ring a carrying lubricating film which hinders their metal contact. It lubricates surfaces where friction arises, it has cooling effect, it protects the bearing from corrosion and in many cases seals the bearing space.

In the most cases - approximately 90%, bearings are lubricated with grease or oil, in rare exceptions by other lubricating means. When deciding which lubricant and which lubrication type should be used, operating conditions, characteristic qualities of the lubricant, equipment design and operating economy should be taken into account.

4.1 Grease Lubrication

In the design practice grease lubrication is preferred to oil lubrication from the point of view of arrangement simplicity, utilization of the sealing capabilities and simple maintenance.

For reliable bearing operation 1/3 to 1/2 of its free space is filled with grease at the first assembly. A greater grease amount has negative influence on the operation. Higher passive resistances cause the inner bearing space warming up undesirably, which can lead to its breakdown. Bearings making only a small number of revolutions during operation, from the point of view of corrosion protection should be completely filled.

4.1.1 Relubrication Interval

Relubrication interval is the period during which the grease has the necessary lubricating properties. After this period bearing must be relubricated, and old lubricant must be removed from the bearing space completely.

Relubricating period depends on the bearing type and size, rotational speed, operating temperature and grease quality. The recommended relubrication period for individual bearing types at normal load ($P \leq 0.15 C$) and normal operational conditions is shown in diagrams in Pict. 22 and 23. The diagrams are valid for common greases and temperatures to $+70^\circ\text{C}$. For temperatures over $+70^\circ\text{C}$, the relubrication period is shortened for each 15°C on the half of original value. For temperatures under $+40^\circ\text{C}$ the relubrication period can be doubled.

For small sized, especially single row ball bearings, the relubrication periods are several times longer than the bearing life, that is why the bearings are, as a rule, not relubricated.

For this reason it is advantageous to use these bearings shielded or sealed on both sides and filled with grease. For some rotational speeds the relubrication period is out of the diagram curve, i.e. the permissible limit for grease lubrication has been reached and oil lubrication should be used.

Necessary grease quantity for relubrication is calculated from the equation:

$$Q = 0.005 DB$$

Q	- grease quantity	[g]
D	- bearing outer diameter	[mm]
B	- bearing width	[mm]

For bearings with higher rotational speed requiring a more frequent relubrication, it is necessary to remove the used lubrication from the bearing space so that temperature increase should not occur. For this reason the grease escape valve is suitable.

Pict. 22

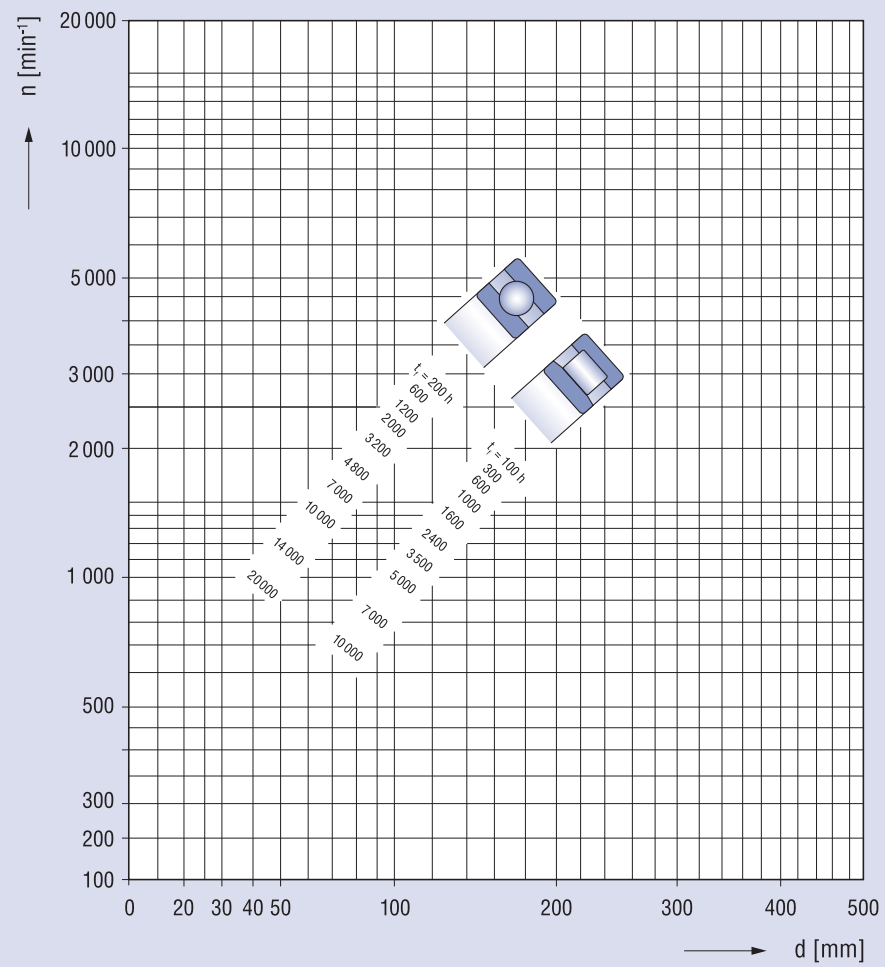

Pict. 23

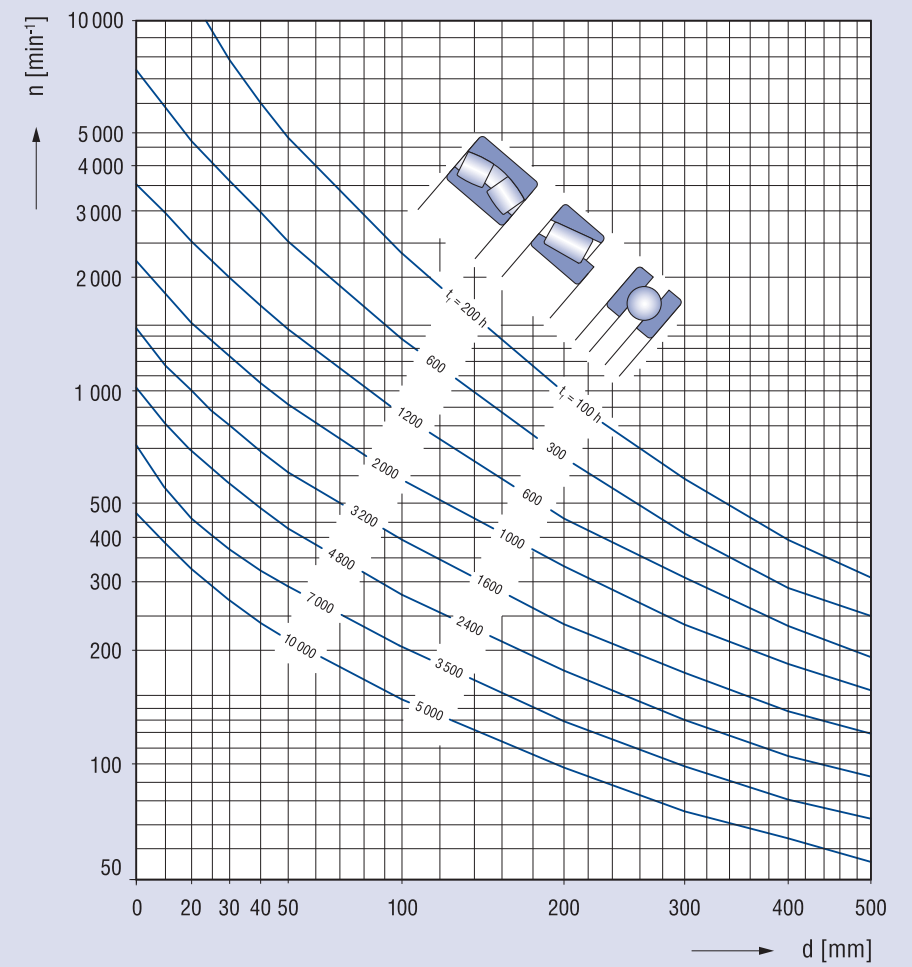

4.1.2 Bearing Greases

Bearing greases are produced most often of quality mineral or synthetic oils (sometimes with additives), thickened with fatty acid metallic soaps. Greases must have good lubricating properties and high chemical, temperature and mechanical stability. The grease list of bearing lubricants is in Table 41.

Rolling Bearing Grease Properties

Table 41

Kind of Grease		Properties		
Thickening Agent	Basic Oil	Operating Temperature Extent [°C]	Resistance against Water	Using
lithium soap	mineral	-20 ÷ 130	resistant	multi-purpose lubricant
lime soap	mineral	-20 ÷ 50	high resistance	good sealing effect against water
soda soap	mineral	-20 ÷ 100	irresistant	emulsifies with water
aluminium soap	mineral	-20 ÷ 70	resistant	good sealing effect against water
complex lithium soap	mineral	-20 ÷ 150	resistant	multi-purpose lubricant
complex lime soap	mineral	-30 ÷ 130	high resistance	multi-purpose lubricant suitable for higher temperatures and load
complex soda soap	mineral	-20 ÷ 130	resistant	suitable for higher temperature and load
complex aluminium soap		-20 ÷ 150	mineral	suitable for higher temperature and load
complex barium soap	mineral	-30 ÷ 140	resistant	suitable for higher temperature and load
bentonite	mineral		resistant	suitable for high temperatures at low rotational speed
polyurea	mineral	-20 ÷ 160	resistant	suitable for high temperatures at medium rotational speed
lithium soap	silicon	-40 ÷ 170	high resistance	suitable for wide temperature range at medium rotational speed
complex barium soap	ester	-60 ÷ 140	resistant	suitable for higher temperatures and higher rotational speeds

4.2 Oil Lubrication

Oil lubrication is used, when operating rotational speed is so high that the grease relubrication period is too short. Another reason can also be the necessity of heat transfer from the bearing, or the high temperature of environment, which does not enable utilization of grease, or if surrounding parts are already lubricated by oil (e.g. geared wheels in the gear box). Except for some cases, spherical roller thrust bearings are always lubricated by oil.

When oil lubricating, lubricating must be secured both at starting and during operation. Excess oil increases temperature and bearing temperature.

Oil feed into bearing is secured in various design ways, out of which oil bath lubrication with oil level reaching middle of the lowest rolling element, oil circulation lubrication, jet lubrication, oil mist lubrication etc., are the most common.

4.2.1 Bearing Oils

For bearing lubrication mostly refined oils with good chemical stability which can be improved by antioxidizing agents are used.

The decisive oil property is kinematic viscosity which decreases with increasing temperature. Suitable oil viscosity ν_1 can be stated according to the diagram in Pict. 23 in dependence on the bearing mean diameter $d_s = (d+D)/2$ and rotational speed n . If the operating temperature is known or it can be found out, according to the diagram in Pict. 24 suitable oil and viscosity ν at internationally standardized temperature 40°C being necessary for calculation of ratio λ is determined.

By ratio $\lambda < 1$ it is recommended to use EP oil with additives which improve the oil film load rating. By value λ decrease under 0.4 oils with EP additives are always used.

If the ratio λ is greater than 1, improved arrangement reliability is reached in operation.

Example :

- bearing $d = 180$ mm, $D = 320$ mm, $d_s = 250$ mm
- rotational speed $n = 500$ min⁻¹
- presumed operating temperature 60°C

For these conditions according to diagram in Pict. 24 the minimum kinematic viscosity is $\nu_1 = 17$ mm².s⁻¹.

If the operating temperature is 60°C, the oil selected according to the diagram in Pict. 25 at standardized temperature 40°C must have kinematic viscosity ν min. 35 mm².s⁻¹.

4.3 Lubrication with Solid Lubricants

Solid lubricants are used for bearing lubrication when the grease or oil cannot fulfil the requirements for reliable lubrication in conditions of limiting friction or from the viewpoint of high operating temperatures, chemical influences, etc.

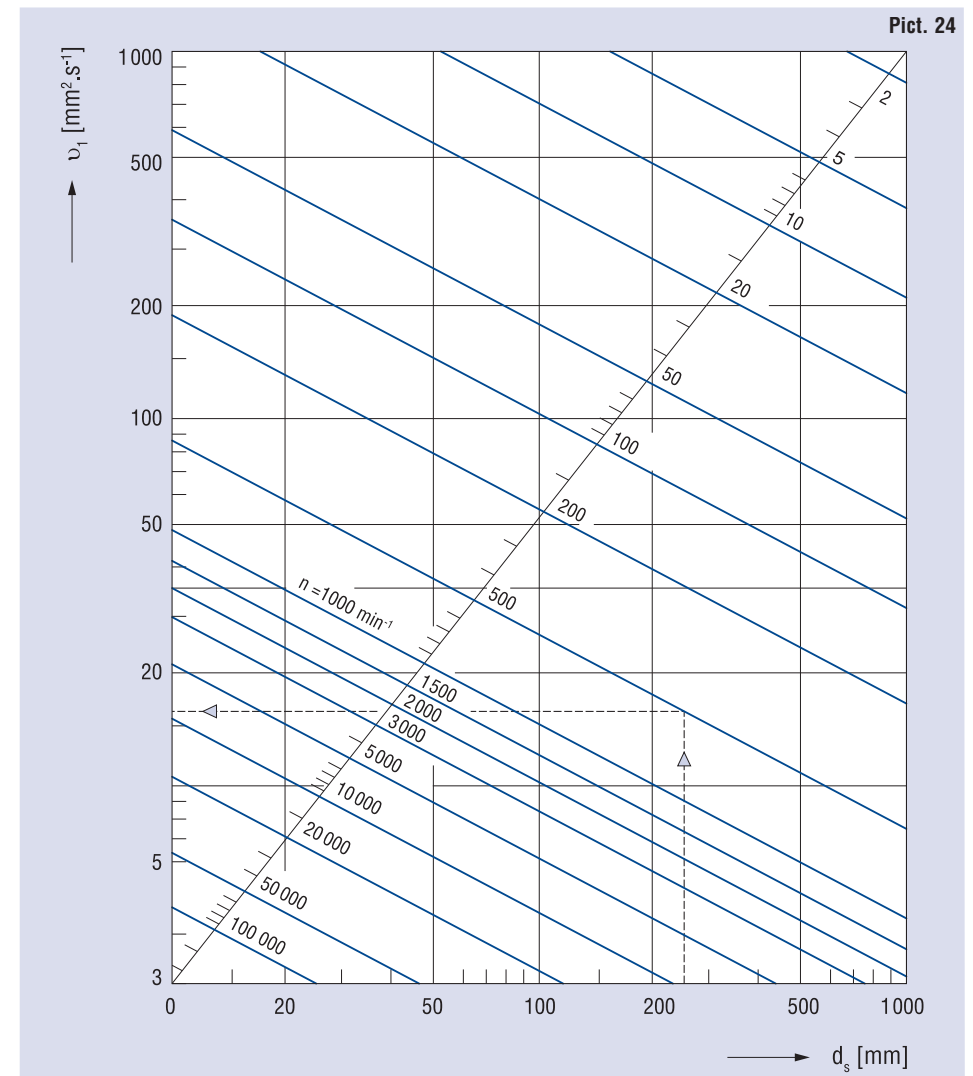

Pict. 25

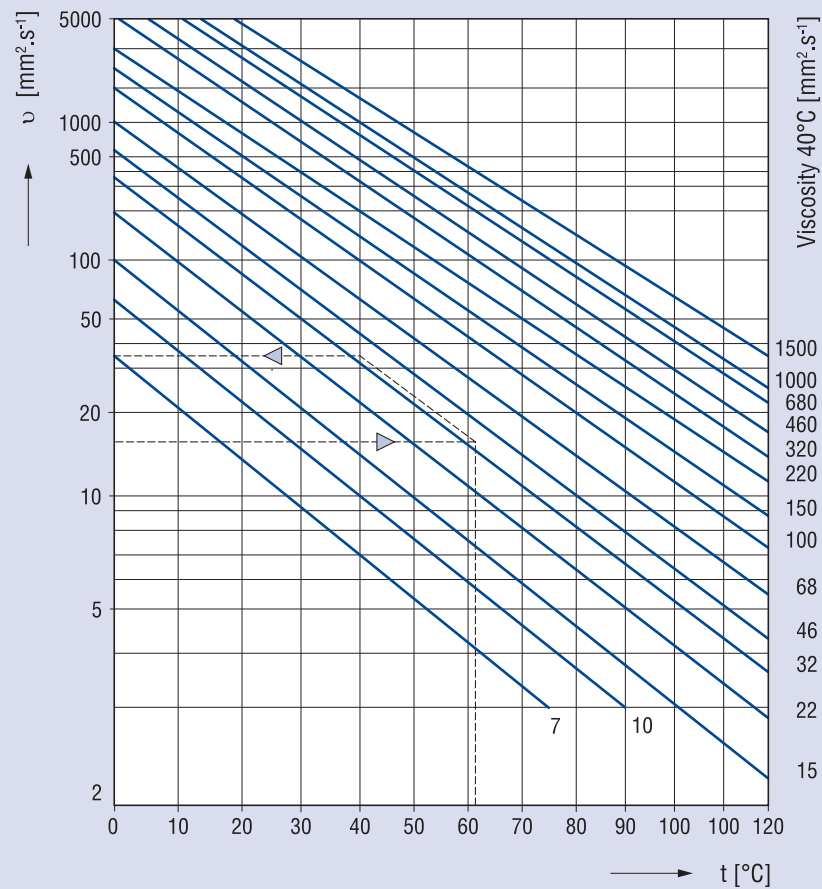

5. Mounting and Dismounting Rolling Bearings

A very important requirement besides using the suitable mounting or dismounting tool is to make sure these tools are clean and the whole operation can be carried out in clean working environment. If this is not fulfilled, the impurities have decisive influence on the bearing behaviour in operation and can also cause bearing breakdown. In the same way the cleanliness conditions must be fulfilled by the preparation of all lubricating means and components connected with the arrangement.

New bearings are preserved by manufacturer with preservatives which need not be removed before mounting. Bearings should be taken out just before mounting. Rarely the preservative is removed from the bearing. For this operation are used:

- gas with 5 to 10% oil additive
- benzol, - diesel fuel, - water-free oil

After washing the bearing should be oiled, preserved from pollution and mounted as soon as possible.

Before mounting, the seating surfaces dimensions should be checked for cleanliness or damage.

Mounting Bearings with Cylindrical Bore

Bearings with cylindrical bore are mounted on the shaft at room temperature or heated. Dimensionally smaller bearings are mostly mounted at room temperature.

The force necessary for mounting is reached by hammer blows or more suitably by press. In both cases mounting jig is used. At mounting it is not permissible to transfer the mounting force through rolling elements. That is why the jig must always be placed on the ring or both rings being mounted while the mounting force is acting.

Heat mounting is used for greater bearings whose rings are fitted with a greater interference. Maximum heating temperature of the bearing is 100°C.

Mounting Bearings with Tapered Bore

Bearings with a tapered bore are mounted on the shaft by means of adapter or withdrawal sleeves or are seated directly on the tapered journal. Reliable mounting is reached either by pressing the inner ring by a nut, or by sufficient inserting of the sleeve. In both cases the inner ring expands and bearing radial clearance decreases.

When mounting double row self aligning ball bearings the adapter sleeve nut can be tightened, but only to such an extent that the outer ring can be easily turned and swivelled.

6. Standards

Survey of national and international standards utilized by design, production, warehousing and sales of bearings:

- ISO 15 Rolling bearings Radial bearings Boundary dimensions, general plan.
- ISO 76 Rolling bearings. Static load ratings.
- ISO 104 Rolling bearings. Thrust bearings. Boundary dimensions, general plan.
- ISO 199 Rolling bearings. Thrust bearings. Geometrical product specification (GPS) and tolerance values.
- ISO 246 Rolling bearings. Cylindrical roller bearings, separate thrust collars. Boundary dimensions.
- ISO 281 Rolling bearings. Dynamic load ratings and rating life.
- ISO 355 Rolling bearings. Tapered roller bearings. Boundary dimensions and series designations.
- ISO 464 Rolling bearings. Radial bearings with locating snap ring. Dimensions, geometrical product specifications (GPS) and tolerance values.
- ISO 492 Rolling bearings. Radial bearings. Geometrical product specifications (GPS) and tolerance values.
- ISO 5753-1 Rolling bearings. Internal clearance. Part 1: Radial internal clearance for radial bearings.
- ISO 582 Rolling bearings. Chamfer dimensions. Maximum values.
- ISO 2982-1 Rolling bearings. Accessories. Part 1: Dimensions for adapter sleeve assemblies and withdrawal sleeves.
- ISO 2982-2 Rolling bearings. Accessories. Part 2: Dimensions for locknuts and locking devices.
- ISO 3228 Rolling bearings. Cast and pressed housings for insert bearings. Boundary dimensions and tolerances.
- ISO 3290-1 Rolling bearings. Balls. Part 1: Steel balls.
- ISO 9628 Rolling bearings. Insert bearings and eccentric locking collars. Geometrical product specifications (GPS) and tolerance values.
- ISO 12240-1 Spherical plain bearings. Part 1: Radial spherical plain bearings.
- EN 12080 Railway applications. Axleboxes. Rolling bearings.
- EN 12082 Railway applications. Axleboxes. Performance testing UIC 515-5 Powered and trailing stock. Bogies. Running gear. Tests for axle-boxes.

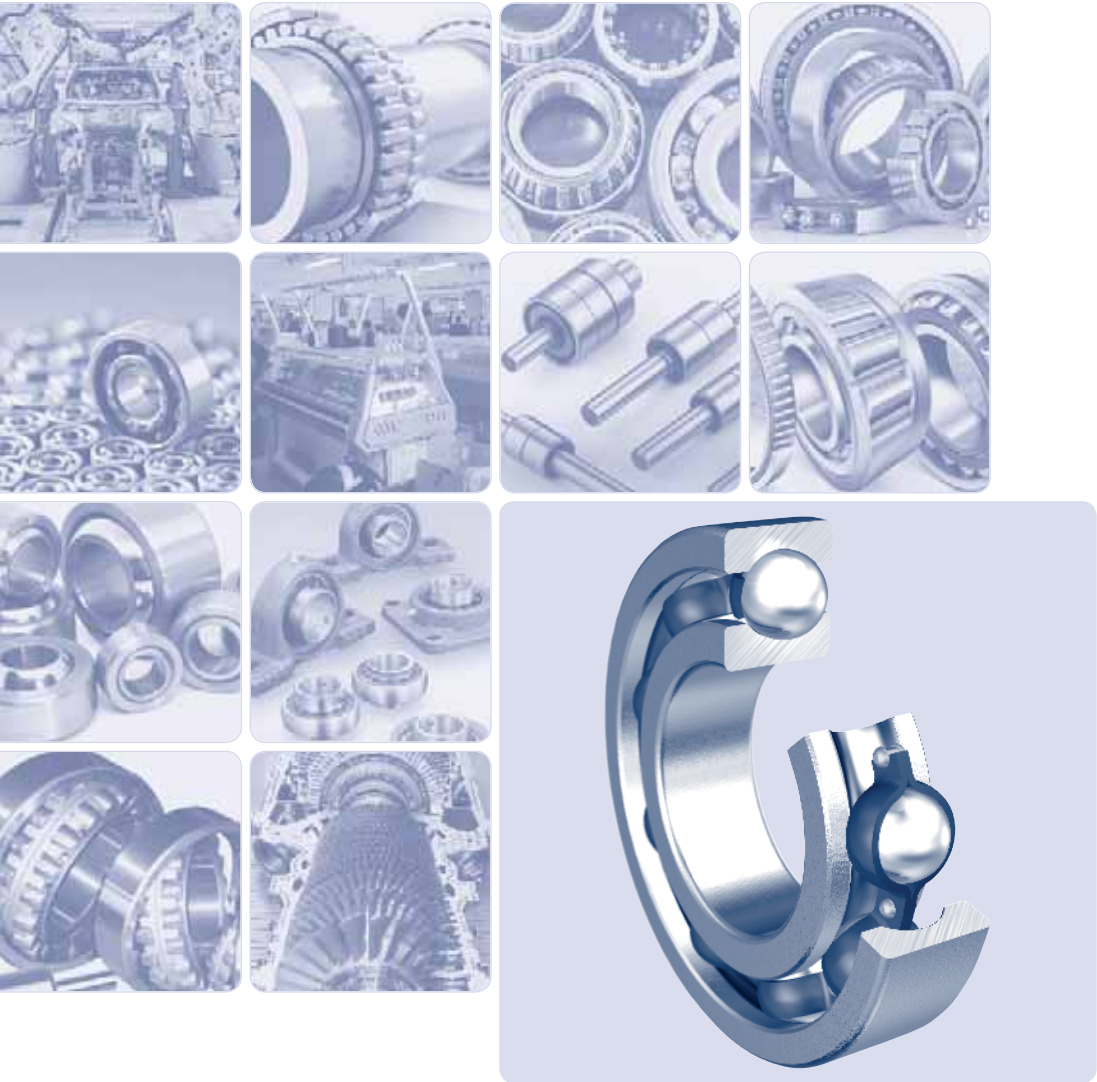

Single Row Deep Groove Ball Bearings

Single Row Deep Groove Ball Bearings

Single Row Deep Groove Ball Bearings

The single row deep groove ball bearings have relatively deep raceways on both rings without a filling slot and are non-separable. High load ratings are achieved by optimum ball sizes and by their conformity to the raceways. They can carry axial and radial loads in both directions and are suitable even for high rotational speeds. These bearings are manufactured in a broad assortment and are the most common rolling bearing type.

The table section are processed basic bearing parameters for the following subgroups:

- Miniature Bearings
- Thin walled Bearings 618 and 619 Series
- Standard assortment 160, 60, 62, 63 and 64 Series
- Bearings with Snap Ring Groove on Outer Ring

The outer ring with one rib of separable single row ball bearings, types E and BO, is designed so that the inner ring with a cage and rolling elements can be mounted separately. The bearings are manufactured with a bore diameter up to $d = 180$ mm and are suitable for lighter loads and high-speed applications.

Boundary Dimensions

Boundary dimensions of the single row deep groove ball bearings given in the dimension tables with the exception of separable single row ball bearings of types E and BO, correspond to the international standard ISO 15. The snap ring groove dimensions comply with the international standard ISO 464.

Bearings with Shields or Seals

The single row deep groove ball bearings with sealing on one or on both sides are manufactured with metallic shields (Z, -2Z or ZR, -2ZR) or with seals (RS, -2RS or RSR, -2RSR).

Bearings with shields have a non-contact sealing. The bearings are manufactured in the original design with steps for shields on the inner ring (Z, -2Z) or, in the new design, with a shield and a smooth rib on the inner ring (ZR, -2ZR).

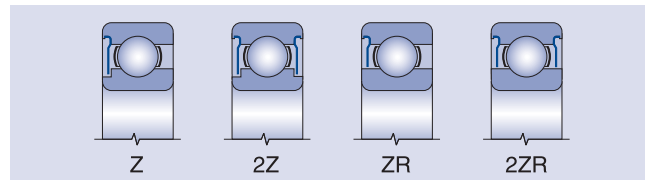

The sealing rings made of rubber, vulcanized on metallic reinforced rings, provide an effective friction type seal. The bearings are manufactured in the design with rounded steps on the inner ring (RS, 2RS) or, in a new design, with a seal and a smooth rib on the inner ring (RSR, -2RSR).

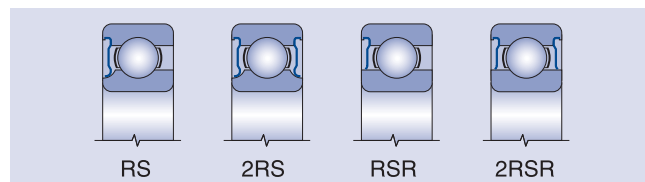

Bearings with seals can be used within the temperature range from -30°C to 110°C .

Supplies of bearings with seals within the operating temperature range from -60°C to 180°C (RS2, 2RS2) should be negotiated with the supplier in advance.

Shields and seals are firmly fixed in the groove of the outer ring and these are not removable.

Bearings with sealings on both sides (-2Z, -2RS or -2ZR, -2RSR) are filled with a quality grease the properties of which usually ensure the lubrication during the whole bearing life under normal operating conditions. The bearings of this design cannot be relubricated and can be used within the operating temperature range from -30°C to 100°C . The supply of bearings with a different grease should be negotiated with the supplier in advance.

Grease

For bearings sealed on both sides, the designation of the grease filling different from standard grease is indicated by a symbol combination the first two letters of which indicate the operating temperature range (a symbol in accordance with STN 02 4608) and the third symbol identifies the grease name.

- TL – Grease for low operating temperatures (from -60°C up to 100°C)
- TM – Grease for medium operating temperatures (from -30°C up to 110°C)
- TH – Grease for high operating temperatures (from -30°C up to 200°C)
- TW – Grease for low and high operating temperatures (from -40°C up to 150°C)

Note: The symbols of greases for medium operating temperatures need not be marked on the bearings.

Bearings with Snap Ring Groove

The single row deep groove ball bearings with a snap ring groove (N) can be axially fixed in the housings easily and without high requirements on the space available simplifying the arrangement design.

For bearings with a groove in the outer ring, snap rings corresponding to STN 02 4605 are used (commercial designation R and the number indicating the outside diameter D of the corresponding bearing, e. g. R47).

Bearings with a snap ring groove and a locking snap ring are designated by the suffix NR, e. g. 6204NR. Locking snap rings for the bearings with a snap ring groove are supplied separately.

The bearings with a snap ring groove can also be supplied in the modification with shields or seals (ZN, -2ZN or RSN, -2RSN). The supply of these bearings must be negotiated in advance.

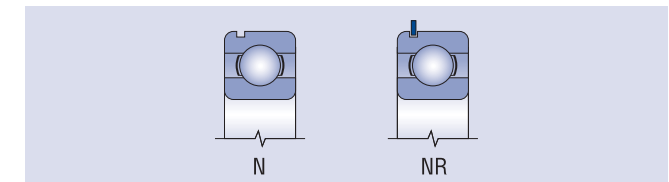

Tapered Bore

For some less demanding applications, e. g. in agricultural machines, etc., some sizes of single row deep groove ball bearings of type 62 and 63 with a tapered bore (K), taper 1:12, are manufactured. These bearings are also manufactured in a design with shields on both sides. The bearings are fixed on the cylindrical shaft by means of adapter sleeves of types H2, H3 or directly on the tapered shaft.

Cages

The single row deep groove ball bearings of the basic design are equipped with a pressed cage made of steel sheet, guided on balls, which is not designated.

These bearings are produced with different types of cages for special applications. Namely, bearings with a solid polyamide cage (TNH, TNGH) and a machined brass cage (M). The supply of these bearings should be negotiated in advance.

Tolerances

The limiting values of the dimensional and running accuracy deviation correspond to ISO 492. An exception is made only for the Single row deep groove ball bearings are commonly manufactured within the tolerance class P0 and P6. For special applications requiring high accuracy or for applications with a high rotational speed, the bearings in the higher tolerance clas-

ses P6, P5 and P4 are used. The bearings in higher tolerance class P6E are used for rotating electric machines.

The limiting values of the dimensional and runing accuracy deviation correspond to ISO 492. An exception is made only for the separable single row ball bearings of types E or B0 the outer diameter D of which has the limiting deviation +0.01/0.00 mm.

The bearings in the tolerance classes P5 and P4 are made of higher quality materials such as electroslag or vacuum remelted bearing steels.

Radial Clearance

The commonly manufactured single row deep groove ball bearings have a normal radial clearance which is not indicated. For special arrangements the bearings with a reduced radial clearance (C2) or with an increased radial clearance (C3, C4, C5) are supplied.

Vibration Level

The currently manufactured single row deep groove ball bearings have a normal vibration level determined by the manufacturer. For special applications with high requirements on noisless operation, bearings with reduced vibration level are supplied (C6).

Symbol Combination

The symbols for the tolerance classes, bearing internal clearances and vibration levels are combined with the simultaneous omission of the symbol C in the second and the following bearing special characteristics, e. g.:

P6 + C3 = P63	6004 P63
C3 + C6 = C36	6303-2RS C36
P6 + C3 + C6 = P636	6204-2Z P636

Stabilisation for Operation at Higher Temperature

For arrangements with a higher operating temperature than 120°C, special heat treated-stabilised-single row deep groove ball bearings are supplied the form stability of which at operating temperature 150°C up to 400°C (S0, S1, S2, S3, S4, S5) is ensured.

The supply of stabilised bearings should be negotiated with the supplier in advance.

Misalignment

For single row deep groove ball bearings only small mutual misalignment of bearing rings is permissible, therefore alignment deviation of seating surfaces can be very small. Misalignment causes additional loading of the bearing and thus its life is shortened.

Values of permissible misalignment at normal operating conditions are shown in the table.

Bearing Type	Load light ($F_r < 0.15 C_{Or}$)	heavy ($F_r \geq 0.15 C_{Or}$)
618, 619, 160, 60	2' to 6'	5' to 10'
62, 63, 64	5' to 10'	8' to 16'

Radial Equivalent Dynamic Load

Single row deep groove ball bearings:

$$P_r = F_r \text{ for } F_a / F_r \leq e \quad P_r = 0.56 F_r + Y F_a \text{ for } F_a / F_r > e$$

Separable single row ball bearings:

$$P_r = F_r \text{ for } F_a / F_r \leq 0.2 \quad P_r = 0.5 F_r + 2.5 F_a \text{ for } F_a / F_r > 0.2$$

Coefficients

F_a/C_{Or}	e	Y
0.025	0.22	2
0.040	0.24	1.8
0.070	0.27	1.6
0.130	0.31	1.4
0.250	0.37	1.2
0.500	0.44	1

Radial Equivalent Static Load

Single Row Deep Groove Ball Bearings:

$$P_{Or} = 0.6 F_r + 0.5 F_a \text{ (} P_{Or} \geq F_r \text{)}$$

Separable Single Row Ball Bearings:

$$P_{Or} = 0.9 F_r + 0.3 F_a \text{ (} P_{Or} \geq F_r \text{)}$$

Designation

The bearing designation in the basic or current modified design is indicated in the dimension tables. The modification of the basic design is designated by additional symbols (prefixes and suffixes) in accordance with STN 02 4608. The meaning of the most frequently used symbols for the single row deep groove ball bearings is indicated in the table.

Symbol	Example of designation	Meaning
X	X 625 P5	Stainless steel
RS	6002RS	Single seal
-2RS	6300-2RS	Double seal
RSR	6210RSR	Seal on one side adhering to flat rib surface of inner ring
-2RSR	6210-2RSR	Seals on both sides adhering to flat rib surface of inner ring
Z	6317Z	Metallic shield on one side
ZN	6204ZN	Metallic shield on one side and snap ring groove on the opposite side
-2Z	6308-2Z	Metallic shields on both sides
-2ZR	6005-2ZR	Metallic shields on both sides resting on the flat rib of inner ring
K	6204-2ZK	Tapered bore with taper 1:12
N	6416N	Snap ring groove in outer ring
NR	6310NR	Snap ring groove in outer ring and inserted snap ring
Y	X 623Y P5	Pressed brass cage, rolling element centered
TNH	6002TNH	Balls guided plastic cage
M	6319M	Solid brass cage guided on balls
MA	6209MA	Solid brass cage guided on outer ring
TB	6308TB	Solid cage made of textite, guided on inner ring
P6	6303 P6	Tolerance class higher than normal
P6E	6204-2Z P6E	Higher tolerance class for rotating electric machines
P5	6208 P5	Tolerance class higher than P6
P4	6007 P4	Tolerance class higher than P5
C2	6003 C2	Radial clearance smaller than normal
C3	6302-2ZR C3	Radial clearance greater than normal
C4	6005-2RS C4	Radial clearance greater than C3
C5	6303-2ZR C5	Radial clearance greater than C4
C6	6300 C6	Reduced vibration level
R...	6210 R10-20	Radial clearance in non-standardized range (range in μm)
S0	6204 S0	Stabilization for operation at temperature up to 150°C
S1	6301 S1	Stabilization for operation at temperature up to 200°C
S2	6303-2ZR C5S2	Stabilization for operation at temperature up to 250°C
S3	6303-2ZR C5S3	Stabilization for operation at temperature up to 300°C
S4	6306-2ZR C5S4	Stabilization for operation at temperature up to 350°C
S5	6306-2ZR C5S5	Stabilization for operation at temperature up to 400°C
TPF	6204-2Z P6E TPF	Bearings manufactured according to special technical terms agreed upon with the customer

Miniature Single Row Deep Groove Ball Bearings

d = 3 - 6 mm

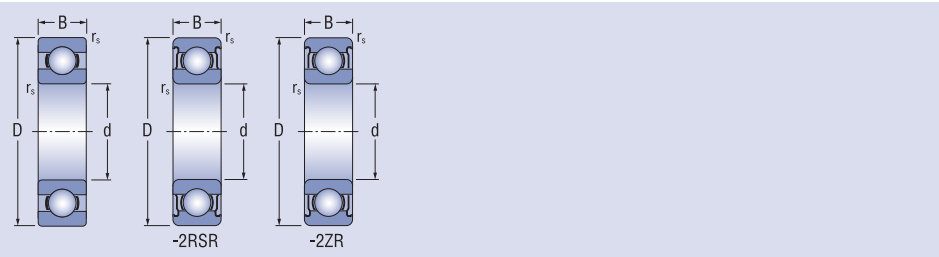

Dimensions				Bearing designation	Basic load rating		Fatigue load limit	Limiting speed		Mass
d	D	B	rs min		dynamic	static		for lubrication with grease	oil	
mm					C _r	C _{0r}	C _u	min ⁻¹		kg
3	9	3	0.2	603	0.39	0.14	0.006	52 000	63 000	0.90
	10	4	0.2	623	0.64	0.22	0.010	42 000	50 000	1.63
	10	4	0.2	623-2RSR	0.64	0.22	0.010	32 000		1.65
	10	4	0.2	623-2ZR	0.64	0.22	0.010	42 000		1.65
	13	4	0.2	633	1.16	0.40	0.018	39 000	46 000	3.33
	13	4	0.2	633-2RSR	1.16	0.40	0.018	29 000		3.38
	13	4	0.2	633-2ZR	1.16	0.40	0.018	39 000		3.38
4	12	4	0.2	604	0.71	0.28	0.013	45 000	52 000	2.25
	12	4	0.2	604-2RSR	0.71	0.28	0.013	33 000		2.29
	12	4	0.2	604-2ZR	0.71	0.28	0.013	45 000		2.29
	13	5	0.2	624	1.16	0.40	0.018	39 000	46 000	3.02
	13	5	0.2	624-2RSR	1.16	0.40	0.018	29 000		3.04
	13	5	0.2	624-2ZR	1.16	0.40	0.018	39 000		3.04
	16	5	0.3	634	1.48	0.61	0.028	35 000	42 000	5.21
	16	5	0.3	634-2RSR	1.48	0.61	0.028	24 000		5.25
16	5	0.3	634-2ZR	1.48	0.61	0.028	35 000		5.25	
5	14	5	0.2	605	1.06	0.44	0.020	38 000	45 000	3.48
	14	5	0.2	605-2RSR	1.06	0.44	0.020	28 000		3.54
	14	5	0.2	605-2ZR	1.06	0.44	0.020	38 000		3.54
	16	5	0.3	625	1.48	0.61	0.028	35 000	42 000	4.86
	16	5	0.3	625-2RSR	1.48	0.61	0.028	23 000		4.92
	16	5	0.3	625-2ZR	1.48	0.61	0.028	35 000		4.92
	19	6	0.3	635	2.24	0.91	0.041	30 000	38 000	8.34
	19	6	0.3	635-2RSR	2.24	0.91	0.041	19 000		8.52
	19	6	0.3	635-2ZR	2.24	0.91	0.041	30 000		8.52
6	17	6	0.3	606	1.48	0.61	0.028	38 000	45 000	5.97
	17	6	0.3	606-2RSR	1.48	0.61	0.028	26 000		6.08
	17	6	0.3	606-2ZR	1.48	0.61	0.028	38 000		6.08
	19	6	0.3	626	2.24	0.91	0.041	30 000	38 000	7.94
	19	6	0.3	626-2RSR	2.24	0.91	0.041	21 000		8.10
	19	6	0.3	626-2ZR	2.24	0.91	0.041	30 000		8.10
	22	7	0.3	636	3.31	1.37	0.062	34 000	40 000	14.00
	22	7	0.3	636-2RSR	3.31	1.37	0.062	22 000		14.23
	22	7	0.3	636-2ZR	3.31	1.37	0.062	34 000		14.23

Miniature Single Row Deep Groove Ball Bearings

d = 7 - 9 mm

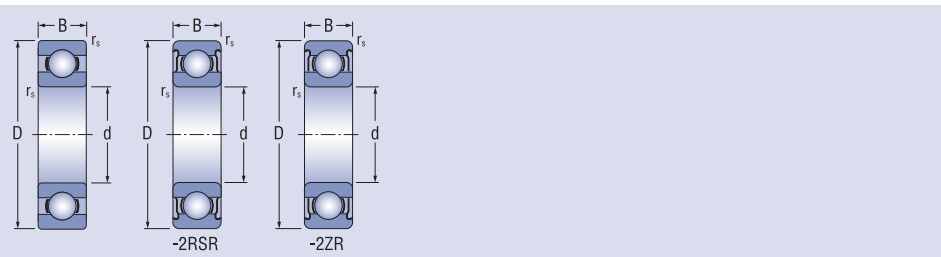

Dimensions				Bearing designation	Basic load rating		Fatigue load limit	Limiting speed for lubrication with		Mass
d	D	B	r _s min		C _r	C _{0r}		grease	oil	
mm					kN			min ⁻¹	kg	
7	19	6	0.3	607	2.24	0.91	0.028	35 000	42 000	7.51
	19	6	0.3	607-2RSR	2.24	0.91	0.028	24 000		7.65
	19	6	0.3	607-2ZR	2.24	0.91	0.028	35 000		7.65
	22	7	0.3	627	3.31	1.37	0.062	34 000	40 000	12.70
	22	7	0.3	627-2RSR	3.31	1.37	0.062	22 000		12.90
	22	7	0.3	627-2ZR	3.31	1.37	0.062	34 000		12.90
	19	6	0.3	637	4.55	1.97	0.090	29 000	35 000	24.00
	19	6	0.3	637-2RSR	4.55	1.97	0.090	17 000		24.35
	19	6	0.3	637-2ZR	4.55	1.97	0.090	29 000		24.35
8	22	7	0.3	608	3.31	1.37	0.062	34 000	40 000	12.10
	22	7	0.3	608-2RSR	3.31	1.37	0.062	23 000		12.20
	22	7	0.3	608-2ZR	3.31	1.37	0.062	34 000		12.20
	24	8	0.3	628	3.35	1.43	0.065	28 000	34 000	17.20
	24	8	0.3	628-2RSR	3.35	1.43	0.065	20 000		17.40
	24	8	0.3	628-2ZR	3.35	1.43	0.065	28 000		17.40
9	24	7	0.3	609	3.33	1.41	0.064	32 000	38 000	14.50
	24	7	0.3	609-2RSR	3.33	1.41	0.064	20 000		14.70
	24	7	0.3	609-2ZR	3.33	1.41	0.064	32 000		14.70
	26	8	0.3	629	4.55	1.97	0.090	29 000	35 000	19.30
	26	8	0.3	629-2RSR	4.55	1.97	0.090	21 000		19.50
	26	8	0.3	629-2ZR	4.55	1.97	0.090	29 000		19.50

Thin Walled Single Row Deep Groove Ball Bearings (with Shield or Seals)

d = 10 - 30 mm

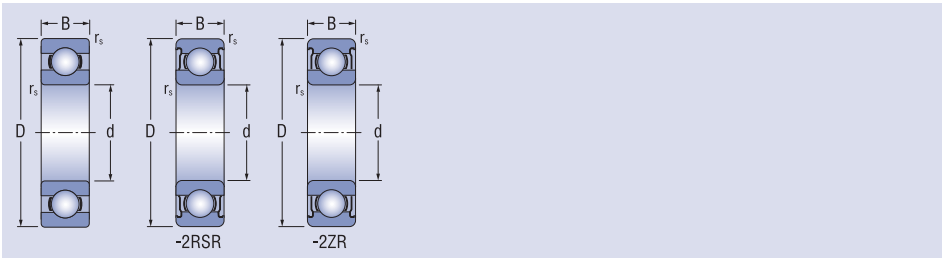

Dimensions				Bearing designation	Basic load rating		Fatigue load limit	Limiting speed for lubrication with		Mass
d	D	B	r _{s min}		C _r	C _{0r}		grease	oil	
mm					kN		C _u	min ⁻¹	kg	
10	19	5	0.3	61800	1.80	0.93	0.04	36 000	42 000	0.005
	19	5	0.3	61800-2RSR	1.80	0.93	0.04	20 000		0.005
	19	5	0.3	61800-2ZR	1.80	0.93	0.04	36 000		0.005
	22	6	0.3	61900	2.70	1.30	0.06	34 000	40 000	0.009
	22	6	0.3	61900-2RSR	2.70	1.30	0.06	19 000		0.009
	22	6	0.3	61900-2ZR	2.70	1.30	0.06	34 000		0.009
12	21	5	0.3	61801	1.90	1.00	0.04	32 000	38 000	0.007
	21	5	0.3	61801-2RSR	1.90	1.00	0.04	19 000		0.007
	21	5	0.3	61801-2ZR	1.90	1.00	0.04	32 000		0.007
	24	6	0.3	61901	2.90	1.48	0.07	30 000	36 000	0.011
	24	6	0.3	61901-2RSR	2.90	1.48	0.07	18 000		0.011
	24	6	0.3	61901-2ZR	2.90	1.48	0.07	30 000		0.011
15	24	5	0.3	61802	2.10	1.30	0.06	28 000	34 000	0.008
	24	5	0.3	61802-2RSR	2.10	1.30	0.06	17 000		0.008
	24	5	0.3	61802-2ZR	2.10	1.30	0.06	28 000		0.008
	28	7	0.3	61902	4.30	2.32	0.10	24 000	30 000	0.016
	28	7	0.3	61902-2RSR	4.30	2.32	0.10	16 000		0.016
	28	7	0.3	61902-2ZR	4.30	2.32	0.10	24 000		0.016
17	26	5	0.3	61803	2.18	1.48	0.07	24 000	30 000	0.019
	26	5	0.3	61803-2RSR	2.18	1.48	0.07	16 000		0.019
	26	5	0.3	61803-2ZR	2.18	1.48	0.07	24 000		0.019
	30	7	0.3	61903	4.60	2.62	0.12	22 000	28 000	0.018
	30	7	0.3	61903-2RSR	4.60	2.62	0.12	14 000		0.018
	30	7	0.3	61903-2ZR	4.60	2.62	0.12	22 000		0.018
20	32	7	0.3	61804	3.48	2.23	0.10	19 000	24 000	0.022
	32	7	0.3	61804-2RSR	3.48	2.23	0.10	13 000		0.022
	32	7	0.3	61804-2ZR	3.48	2.23	0.10	19 000		0.022
	37	9	0.3	61904	6.38	3.68	0.17	18 000	22 000	0.036
	37	9	0.3	61904-2RSR	6.38	3.68	0.17	12 000		0.036
	37	9	0.3	61904-2ZR	6.38	3.68	0.17	18 000		0.036
25	37	7	0.3	61805	4.29	2.91	0.13	17 000	20 000	0.028
	37	7	0.3	61805-2RSR	4.29	2.91	0.13	11 000		0.028
	37	7	0.3	61805-2ZR	4.29	2.91	0.13	17 000		0.028
	42	9	0.3	61905	7.02	4.53	0.21	16 000	19 000	0.042
	42	9	0.3	61905-2RSR	7.02	4.53	0.21	10 000		0.042
	42	9	0.3	61905-2ZR	7.02	4.53	0.21	16 000		0.042
30	42	7	0.3	61806	4.70	3.62	0.16	15 000	18 000	0.026
	42	7	0.3	61806-2RSR	4.70	3.62	0.16	9 500		0.026
	42	7	0.3	61806-2ZR	4.70	3.62	0.16	15 000		0.026
	47	9	0.3	61906	7.21	5.01	0.23	14 000	17 000	0.048
	47	9	0.3	61906-2RSR	7.21	5.01	0.23	8 500		0.048
	47	9	0.3	61906-2ZR	7.21	5.01	0.23	14 000		0.048

Thin Walled Single Row Deep Groove Ball Bearings (with Shield or Seals)

d = 35 - 65 mm

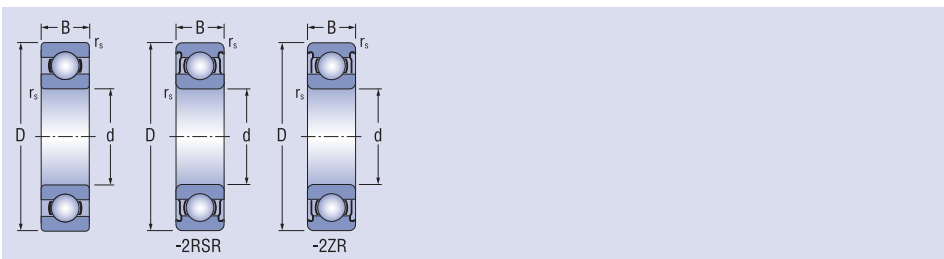

Dimensions				Bearing designation	Basic load rating		Fatigue load limit	Limiting speed for lubrication with		Mass
d	D	B	rs min		dynamic	static		grease	oil	
mm					C _r	C _{0r}	C _u	min ⁻¹	kg	
35	47	7	0.3	61807	4.90	4.05	0.18	13 000	16 000	0.029
	47	7	0.3	61807-2RSR	4.90	4.05	0.18	8 200		0.029
	47	7	0.3	61807-ZZR	4.90	4.05	0.18	13 000		0.029
	55	10	0.6	61907	9.50	6.81	0.31	11 000	14 000	0.074
	55	10	0.6	61907-2RSR	9.50	6.81	0.31	8 100		0.074
	55	10	0.6	61907-ZZR	9.50	6.81	0.31	11 000		0.074
40	52	7	0.3	61808	5.10	4.40	0.20	11 000	14 000	0.033
	52	7	0.3	61808-2RSR	5.10	4.40	0.20	7 000		0.033
	52	7	0.3	61808-ZZR	5.10	4.40	0.20	11 000		0.033
	62	12	0.6	61908	13.70	9.90	0.45	10 000	13 000	0.110
	62	12	0.6	61908-2RSR	13.70	9.90	0.45	6 900		0.110
	62	12	0.6	61908-ZZR	13.70	9.90	0.45	10 000		0.110
45	58	7	0.3	61809	6.40	5.65	0.26	9 500	12 000	0.040
	58	7	0.3	61809-2RSR	6.40	5.65	0.26	6 400		0.040
	58	7	0.3	61809-ZZR	6.40	5.65	0.26	9 500		0.040
	68	12	0.6	61909	14.10	10.90	0.50	8 400	10 000	0.128
	68	12	0.6	61909-2RSR	14.10	10.90	0.50	6 100		0.128
	68	12	0.6	61909-ZZR	14.10	10.90	0.50	8 400		0.128
50	65	7	0.3	61810	6.60	6.10	0.28	9 000	11 000	0.052
	65	7	0.3	61810-2RSR	6.60	6.10	0.28	5 800		0.052
	65	7	0.3	61810-ZZR	6.60	6.10	0.28	9 000		0.052
	72	12	0.6	61910	14.50	11.70	0.53	8 500	10 000	0.132
	72	12	0.6	61910-2RSR	14.50	11.70	0.53	5 500		0.132
	72	12	0.6	61910-ZZR	14.50	11.70	0.53	8 500		0.132
55	72	9	0.3	61811	9.10	8.40	0.38	8 600	10 000	0.083
	72	9	0.3	61811-2RSR	9.10	8.40	0.38	5 500		0.083
	72	9	0.3	61811-ZZR	9.10	8.40	0.38	8 600		0.083
	80	13	1.0	61911	15.90	13.20	0.60	8 100	9 600	0.180
	80	13	1.0	61911-2RSR	15.90	13.20	0.60	5 100		0.180
	80	13	1.0	61911-ZZR	15.90	13.20	0.60	8 100		0.180
60	78	10	0.3	61812	9.15	8.75	0.40	8 000	9 400	0.093
	78	10	0.3	61812-2RSR	9.15	8.75	0.40	4 800		0.093
	78	10	0.3	61812-ZZR	9.15	8.75	0.40	8 000		0.093
	85	13	1.0	61912	16.40	14.20	0.65	7 600	8 900	0.193
	85	13	1.0	61912-2RSR	16.40	14.20	0.65	4 800		0.193
	85	13	1.0	61912-ZZR	16.40	14.20	0.65	7 600		0.193
65	85	10	0.3	61813	11.90	11.50	0.52	7 400	8 700	0.128
	85	10	0.3	61813-2RSR	11.90	11.50	0.52	4 700		0.128
	85	10	0.3	61813-ZZR	11.90	11.50	0.52	7 400		0.128
	90	13	1.0	61913	17.40	16.10	0.73	7 000	8 200	0.206
	90	13	1.0	61913-2RSR	17.40	16.10	0.73	4 600		0.206
	90	13	1.0	61913-ZZR	17.40	16.10	0.73	7 000		0.206

Thin Walled Single Row Deep Groove Ball Bearings (with Shield or Seals)

d = 70 - 100 mm

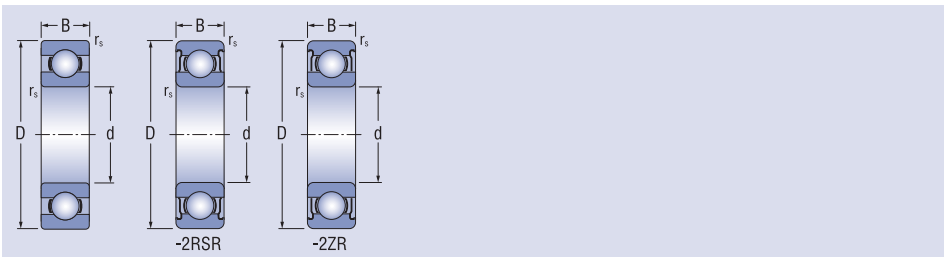

Dimensions				Bearing designation	Basic load rating		Fatigue load limit	Limiting speed for lubrication with		Mass
d	D	B	rs min		dynamic	static		grease	oil	
mm					C _r	C _{0r}	C _u	min ⁻¹		kg
70	90	10	0.6	61814	12.10	11.90	0.54	6 900	8 100	0.138
	90	10	0.6	61814-2RSR	12.10	11.90	0.54	4 500		0.138
	90	10	0.6	61814-2ZR	12.10	11.90	0.54	6 900		0.138
	100	16	1.0	61914	23.70	21.20	0.96	6 500	7 700	0.336
	100	16	1.0	61914-2RSR	23.70	21.20	0.96	4 300		0.336
	100	16	1.0	61914-2ZR	23.70	21.20	0.96	6 500		0.336
75	95	10	0.6	61815	12.50	12.80	0.58	6 400	7 600	0.147
	95	10	0.6	61815-2RSR	12.50	12.80	0.58	4 300		0.147
	95	10	0.6	61815-2ZR	12.50	12.80	0.58	6 400		0.147
	105	16	1.0	61915	24.40	22.60	1.03	6 100	7 200	0.355
	105	16	1.0	61915-2RSR	24.40	22.60	1.03	4 100		0.355
	105	16	1.0	61915-2ZR	24.40	22.60	1.03	6 100		0.355
80	100	10	0.6	61816	12.70	13.30	0.61	6 000	7 100	0.155
	100	10	0.6	61816-2RSR	12.70	13.30	0.61	4 600		0.155
	100	10	0.6	61816-2ZR	12.70	13.30	0.61	6 000		0.155
	110	16	1.0	61916	24.90	24.00	1.09	5 700	6 700	0.375
	110	16	1.0	61916-2RSR	24.90	24.00	1.09	3 800		0.375
	110	16	1.0	61916-2ZR	24.90	24.00	1.09	5 700		0.375
85	110	13	1.0	61817	19.25	19.79	0.90	5 700	6 700	0.245
	110	13	1.0	61817-2RSR	19.25	19.79	0.90	3 400		0.245
	110	13	1.0	61817-2ZR	19.25	19.79	0.90	5 700		0.245
	120	18	1.1	61917	32.00	29.60	1.33	5 400	6 300	0.536
	120	18	1.1	61917-2RSR	32.00	29.60	1.33	3 400		0.536
	120	18	1.1	61917-2ZR	32.00	29.60	1.33	5 400		0.536
90	115	13	1.0	61818	19.57	20.54	0.92	5 400	6 300	0.285
	115	13	1.0	61818-2RSR	19.57	20.54	0.92	3 200		0.285
	115	13	1.0	61818-2ZR	19.57	20.54	0.92	5 400		0.285
	125	18	1.1	61918	33.00	31.50	1.38	5 100	6 000	0.554
	125	18	1.1	61918-2RSR	33.00	31.50	1.38	2 700		0.554
	125	18	1.1	61918-2ZR	33.00	31.50	1.38	5 100		0.554
95	120	13	1.0	61819	19.80	21.30	0.93	5 000	5 900	0.300
	120	13	1.0	61819-2RSR	19.80	21.30	0.93	3 200		0.300
	120	13	1.0	61819-2ZR	19.80	21.30	0.93	5 000		0.300
	130	18	1.1	61919	33.70	33.30	1.43	4 800	5 700	0.579
	130	18	1.1	61919-2RSR	33.70	33.30	1.43	2 900		0.579
	130	18	1.1	61919-2ZR	33.70	33.30	1.43	4 800		0.579
100	125	13	1.0	61820	20.09	22.00	0.94	4 800	5 600	0.313
	125	13	1.0	61820-2RSR	20.09	22.00	0.94	3 200		0.313
	125	13	1.0	61820-2ZR	20.09	22.00	0.94	4 800		0.313
	140	20	1.1	61920	42.70	41.90	1.74	4 500	5 300	0.785
	140	20	1.1	61920-2RSR	42.70	41.90	1.74	3 100		0.785
	140	20	1.1	61920-2ZR	42.70	41.90	1.74	4 500		0.785

Thin Walled Single Row Deep Groove Ball Bearings (with Shield or Seals)

d = 105 - 150 mm

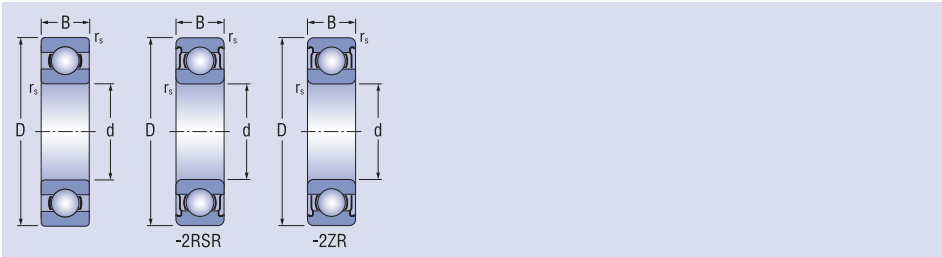

Dimensions				Bearing designation	Basic load rating		Fatigue load limit	Limiting speed for lubrication with		Mass
d	D	B	rs min		dynamic	static		grease	oil	
mm					C _r	C _{0r}	C _u	min ⁻¹		kg
105	130	13	1.0	61821	20.30	22.70	0.94	4 600	5 400	0.324
	130	13	1.0	61821-2RSR	20.30	22.70	0.94	3 100		0.324
	130	13	1.0	61821-2ZR	20.30	22.70	0.94	4 600		0.324
	145	20	1.1	61921	42.50	42.00	1.71	4 300	5 100	0.856
	145	20	1.1	61921-2RSR	42.50	42.00	1.71	2 900		0.856
	145	20	1.1	61921-2ZR	42.50	42.00	1.71	4 300		0.856
110	140	16	1.0	61822	24.90	28.20	1.15	4 300	5 100	0.497
	140	16	1.0	61822-2RSR	24.90	28.20	1.15	2 900		0.497
	140	16	1.0	61822-2ZR	24.90	28.20	1.15	4 300		0.497
	150	20	1.1	61922	43.50	44.50	1.77	4 100	4 800	0.893
	140	20	1.1	61922-2RSR	43.50	44.50	1.77	2 800		0.893
	140	20	1.1	61922-2ZR	43.50	44.50	1.77	4 100		0.893
120	150	16	1.0	61824	24.50	28.10	1.10	4 000	4 700	0.537
	150	16	1.0	61824-2RSR	24.50	28.10	1.10	2 800		0.537
	150	16	1.0	61824-2ZR	24.50	28.10	1.10	4 000		0.537
	165	22	1.1	61924	53.00	54.00	2.06	3 800	4 400	1.21
	165	22	1.1	61924-2RSR	53.00	54.00	2.06	2 400		1.21
	165	22	1.1	61924-2ZR	53.00	54.00	2.06	3 800		1.21
130	165	18	1.1	61826	33.10	37.80	1.41	3 700	4 300	0.758
	165	18	1.1	61826-2RSR	33.10	37.80	1.41	2 400		0.758
	165	18	1.1	61826-2ZR	33.10	37.80	1.41	3 700		0.758
	180	24	1.5	61926	65.00	67.50	2.53	3 500	4 100	1.57
	180	24	1.5	61926-2RSR	65.00	67.50	2.53	2 200		1.57
	180	24	1.5	61926-2ZR	65.00	67.50	2.53	3 500		1.57
140	175	18	1.1	61828	37.20	42.60	1.54	3 400	4 000	0.832
	175	18	1.1	61828-2RSR	37.20	42.60	1.54	2 200		0.832
	175	18	1.1	61828-2ZR	37.20	42.60	1.54	3 400		0.832
	190	24	1.5	61928	66.50	71.30	2.53	3 200	3 800	1.67
	190	24	1.5	61928-2RSR	66.50	71.30	2.53	2 100		1.67
	190	24	1.5	61928-2ZR	66.50	71.30	2.53	3 200		1.67
150	190	20	1.1	61830	45.80	53.30	1.85	3 100	3 700	1.15
	190	20	1.1	61830-2RSR	45.80	53.30	1.85	2 000		1.15
	190	20	1.1	61830-2ZR	45.80	53.30	1.85	3 100		1.15
	210	28	2.0	61930	84.70	90.20	3.04	3 000	3 500	2.47
	210	28	2.0	61930-2RSR	84.70	90.20	3.04	2 000		2.47
	210	28	2.0	61930-2ZR	84.70	90.20	3.04	3 000		2.47

Thin Walled Single Row Deep Groove Ball Bearings (with Shield or Seals)

d = 160 - 300 mm

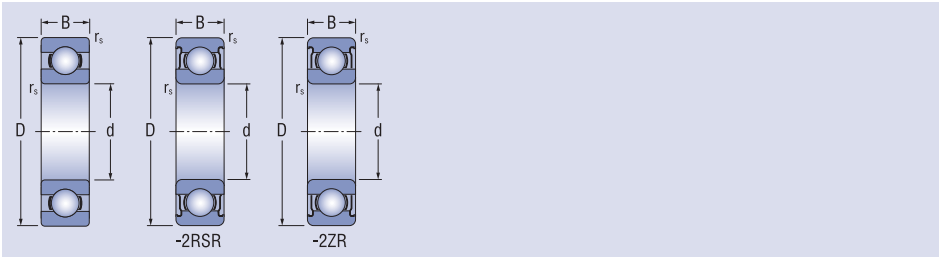

Dimensions				Bearing designation	Basic load rating		Fatigue load limit	Limiting speed for lubrication with		Mass
d	D	B	rs min		dynamic	static		grease	oil	
mm					C _r	C _{0r}	C _u	min ⁻¹		kg
160	200	20	1.1	61832	45.30	55.10	1.86	2 900	3 400	1.23
	200	20	1.1	61832-2RSR	45.30	55.10	1.86	2 000		1.23
	200	20	1.1	61832-ZR	45.30	55.10	1.86	2 900		1.23
	200	20	1.1	61832M	48.40	61.00	2.06	2 900	3 400	1.28
	220	28	2.0	61932	83.50	90.50	2.98	2 700	3 200	3.25
	220	28	2.0	61932-2RSR	83.50	90.50	2.98	1 900		3.25
	220	28	2.0	61932-ZR	83.50	90.50	2.98	2 700		3.25
170	220	28	2.0	61932M	86.90	96.00	3.14	2 700		3.30
	215	22	1.1	61834M	60.00	78.00	2.55	2 700	3 200	1.72
	230	28	2.0	61934M	88.80	100.0	3.15	2 400	3 000	3.40
180	225	22	1.1	61836M	61.00	79.0	2.52	2 600	3 000	2.03
	250	33	2.0	61936M	118.00	133.0	4.12	2 200	2 800	5.05
190	240	24	1.5	61838M	73.00	94.0	2.91	2 200	2 800	2.60
	260	33	2.0	61938M	117.00	134.0	4.06	2 200	2 800	5.25
200	250	24	1.5	61840M	74.00	98.0	2.97	2 200	2 800	2.70
	280	38	2.1	61940M	143.00	158.0	4.63	2 000	2 600	7.40
220	270	24	1.5	61844M	77.00	107.0	3.10	1 900	2 400	3.00
	300	38	2.1	61944M	146.00	169.0	4.76	1 900	2 400	8.00
240	300	28	2.0	61848M	99.00	137.0	3.79	1 800	2 200	4.50
	320	38	2.1	61948M	154.00	190.0	5.02	1 800	2 200	8.60
260	320	28	2.0	61852M	101.00	148.0	3.95	1 700	2 000	4.80
	360	46	2.1	61952M	204.00	255.0	6.58	1 600	1 900	14.50
280	350	33	2.0	61856M	133.0	191.0	4.89	1 600	1 900	7.40
	380	46	2.1	61956M	209.0	272.0	6.80	1 500	1 800	15.00
300	350	33	2.0	61860M	166.0	233.0	5.74	1 400	1 700	10.50
	420	56	3.0	61960M	270.0	375.0	8.98	1 300	1 600	24.50

Single Row Deep Groove Ball Bearings type 622,623

d = 10 - 60 mm

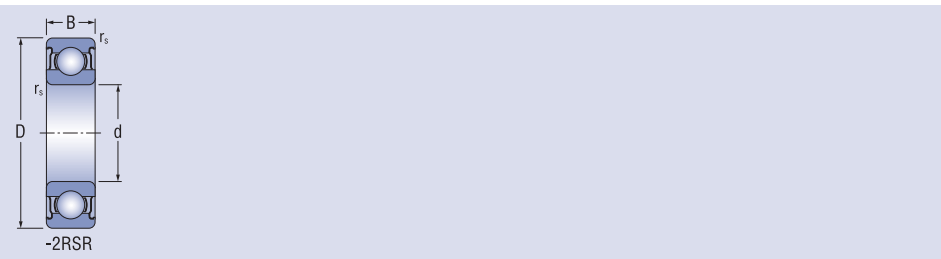

Dimensions				Bearing designation	Basic load rating		Fatigue load limit	Limiting speed for lubrication with		Mass
d	D	B	r _{s min}		C _r	C _{0r}		grease	oil	
mm					kN		C _u	min ⁻¹	kg	
10	30	14	0.3	62200-2RSR	5.95	2.61	0.118	13 000	-	0.04
12	32	14	0.3	62201-2RSR	6.82	3.05	0.139	12 000	-	0.05
15	35	14	0.6	62202-2RSR	7.65	3.72	0.169	10 000	-	0.05
17	40	16	0.6	62203-2RSR	9.58	4.78	0.217	9 000	-	0.09
20	47	18	1.0	62204-2RSR	12.80	6.65	0.302	8 000	-	0.13
25	52	18	1.0	62205-2RSR	14.00	7.88	0.358	7 000	-	0.16
30	62	20	1.0	62206-2RSR	19.50	11.30	0.512	6 000	-	0.25
35	72	23	1.1	62207-2RSR	25.70	15.20	0.695	5 300	-	0.40
40	80	23	1.1	62208-2RSR	29.50	18.10	0.823	4 500	-	0.47
45	85	23	1.1	62209-2RSR	31.70	20.70	0.941	4 300	-	0.51
50	90	23	1.1	62210-2RSR	35.10	23.20	1.054	3 800	-	0.54
55	100	25	1.5	62211-2RSR	43.40	29.20	1.327	3 400	-	0.75
60	110	28	1.5	62212-2RSR	52.50	35.90	1.631	3 200	-	1.00
10	35	17	0.6	62300-2RSR	8.53	3.92	0.040	11 000	-	0.06
12	37	17	1.0	62301-2RSR	9.72	5.08	0.231	10 000	-	0.07
15	42	17	1.0	62302-2RSR	11.50	5.42	0.246	9 000	-	0.11
17	47	19	1.0	62303-2RSR	13.50	6.58	0.298	8 500	-	0.16
20	52	21	1.1	62304-2RSR	15.90	7.88	0.355	7 500	-	0.21
25	62	24	1.1	62305-2RSR	22.40	11.48	0.523	6 000	-	0.32
30	72	27	1.1	62306-2RSR	27.00	15.20	0.691	5 300	-	0.50
35	80	31	1.5	62307-2RSR	33.40	19.20	0.873	4 500	-	0.68
40	90	33	1.5	62308-2RSR	40.75	24.00	1.091	4 000	-	0.92
45	100	36	1.5	62309-2RSR	52.80	31.83	1.447	3 600	-	1.20
50	110	40	2.0	62310-2RSR	61.80	37.90	1.723	3 200	-	1.60
55	120	43	2.0	62311-2RSR	71.60	44.90	2.023	3 000	-	2.05
60	130	46	2.1	62312-2RSR	81.80	51.80	2.354	2 600	-	2.55

Single Row Deep Groove Ball Bearings (with Shield or Seals)

d = 10 - 12 mm

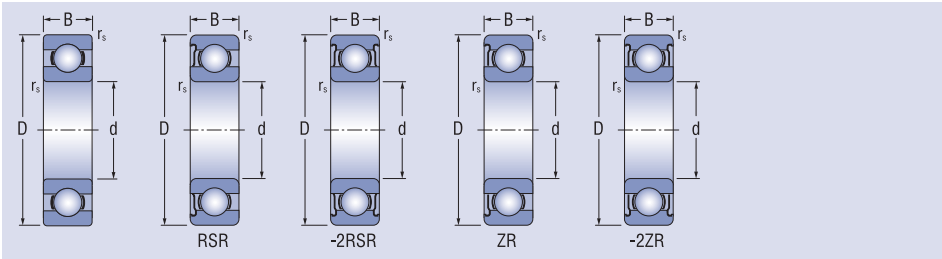

Dimensions				Bearing designation	Basic load rating		Fatigue load limit	Limiting speed for lubrication with		Mass
d	D	B	r _{s min}		dynamic	static		grease	oil	
mm					C _r	C _{0r}	C _u	min ⁻¹	kg	
10	26	8	0.3	6000	4.58	1.98	0.090	31 000	36 000	0.019
	26	8	0.3	6000RSR	4.58	1.98	0.090	19 000		0.019
	26	8	0.3	6000-2RSR	4.58	1.98	0.090	19 000		0.019
	26	8	0.3	6000ZR	4.58	1.98	0.090	31 000	36 000	0.019
	26	8	0.3	6000-2ZR	4.58	1.98	0.090	31 000		0.019
	30	9	0.6	6200	5.10	2.38	0.108	24 000	29 000	0.031
	30	9	0.6	6200RSR	5.10	2.38	0.108	17 000		0.031
	30	9	0.6	6200-2RSR	5.10	2.38	0.108	17 000		0.031
	30	9	0.6	6200ZR	5.10	2.38	0.108	24 000	30 000	0.031
	30	9	0.6	6200-2ZR	5.10	2.38	0.108	24 000		0.031
	35	11	0.6	6300	7.65	3.48	0.158	22 000	27 000	0.054
	35	11	0.6	6300RSR	7.65	3.48	0.158	15 000		0.054
	35	11	0.6	6300-2RSR	7.65	3.48	0.158	15 000		0.054
	35	11	0.6	6300ZR	7.65	3.48	0.158	22 000	27 000	0.054
35	11	0.6	6300-2ZR	7.65	3.48	0.158	22 000		0.054	
12	28	8	0.3	6001	5.10	2.38	0.108	27 000	32 000	0.022
	28	8	0.3	6001RSR	5.10	2.38	0.108	17 000		0.022
	28	8	0.3	6001-2RSR	5.10	2.38	0.108	17 000		0.022
	28	8	0.3	6001ZR	5.10	2.38	0.108	27 000	32 000	0.022
	28	8	0.3	6001-2ZR	5.10	2.38	0.108	27 000		0.022
	32	10	0.6	6201	6.82	3.05	0.139	22 000	27 000	0.037
	32	10	0.6	6201RSR	6.82	3.05	0.139	15 000		0.037
	32	10	0.6	6201-2RSR	6.82	3.05	0.139	15 000		0.037
	32	10	0.6	6201ZR	6.82	3.05	0.139	22 000	27 000	0.037
	32	10	0.6	6201-2ZR	6.82	3.05	0.139	22 000		0.037
	37	12	1.0	6301	9.72	5.08	0.231	20 000	25 000	0.061
	37	12	1.0	6301RSR	9.72	5.08	0.231	13 000		0.061
	37	12	1.0	6301-2RSR	9.72	5.08	0.231	13 000		0.061
	37	12	1.0	6301ZR	9.72	5.08	0.231	20 000	25 000	0.061
37	12	1.0	6301-2ZR	9.72	5.08	0.231	20 000		0.061	

Single Row Deep Groove Ball Bearings (with Shield or Seals)

d = 15 - 17 mm

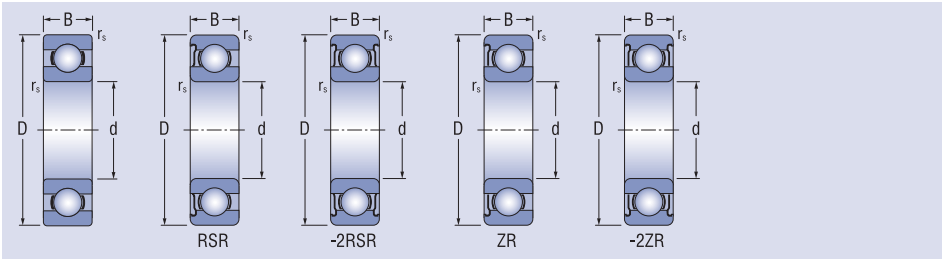

Dimensions				Bearing designation	Basic load rating		Fatigue load limit	Limiting speed for lubrication with		Mass
d	D	B	r _{s min}		C _r	C _{0r}		grease	oil	
mm					kN		min ⁻¹	kg		
15	32	8	0.3	16002	5.58	2.85	0.130	23 000	26 000	0.030
	32	9	0.3	6002	5.58	2.85	0.130	23 000	27 000	0.030
	32	9	0.3	6002RSR	5.58	2.85	0.130	14 000		0.030
	32	9	0.3	6002-2RSR	5.58	2.85	0.130	14 000		0.030
	32	9	0.3	6002ZR	5.58	2.85	0.130	23 000	27 000	0.030
	32	9	0.3	6002-2ZR	5.58	2.85	0.130	23 000		0.030
	35	11	0.6	6202	7.65	3.72	0.169	20 000	24 000	0.046
	35	11	0.6	6202RSR	7.65	3.72	0.169	13 000		0.046
	35	11	0.6	6202-2RSR	7.65	3.72	0.169	13 000		0.046
	35	11	0.6	6202ZR	7.65	3.72	0.169	20 000	24 000	0.046
	35	11	0.6	6202-2ZR	7.65	3.72	0.169	20 000		0.046
	42	13	1.0	6302	11.50	5.42	0.246	17 000	20 000	0.085
	42	13	1.0	6302RSR	11.50	5.42	0.246	12 000		0.085
	42	13	1.0	6302-2RSR	11.50	5.42	0.246	12 000		0.085
42	13	1.0	6302ZR	11.50	5.42	0.246	17 000	20 000	0.085	
42	13	1.0	6302-2ZR	11.50	5.42	0.246	17 000		0.085	
17	35	8	0.3	16003	6.00	3.25	0.148	20 000	24 000	0.033
	35	10	0.3	6003	6.00	3.25	0.148	21 000	25 000	0.040
	35	10	0.3	6003RSR	6.00	3.25	0.148	13 000		0.040
	35	10	0.3	6003-2RSR	6.00	3.25	0.148	13 000		0.040
	35	10	0.3	6003ZR	6.00	3.25	0.148	21 000	25 000	0.040
	35	10	0.3	6003-2ZR	6.00	3.25	0.148	21 000		0.040
	40	12	0.6	6203	9.58	4.78	0.217	17 000	21 000	0.073
	40	12	0.6	6203RSR	9.58	4.78	0.217	12 000		0.073
	40	12	0.6	6203-2RSR	9.58	4.78	0.217	12 000		0.073
	40	12	0.6	6203ZR	9.58	4.78	0.217	17 000	21 000	0.073
	40	12	0.6	6203-2ZR	9.58	4.78	0.217	17 000		0.073
	47	14	1.0	6303	13.50	6.58	0.298	16 000	19 000	0.115
	47	14	1.0	6303RSR	13.50	6.58	0.298	10 600		0.115
	47	14	1.0	6303-2RSR	13.50	6.58	0.298	10 600		0.115
	47	14	1.0	6303ZR	13.50	6.58	0.298	16 000	19 000	0.115
	47	14	1.0	6303-2ZR	13.50	6.58	0.298	16 000		0.115
	62	17	1.0	6403	22.10	7.80	0.354	12 600	15 000	0.270

Single Row Deep Groove Ball Bearings (with Shield or Seals)

d = 20 - 25 mm

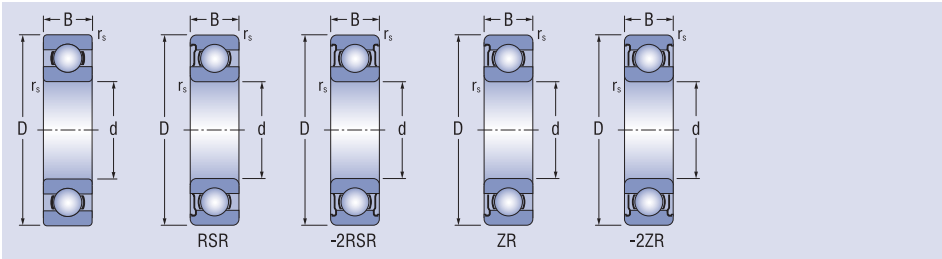

Dimensions				Bearing designation	Basic load rating		Fatigue load limit	Limiting speed for lubrication with		Mass
d	D	B	r _{s min}		C _r	C _{0r}		grease	oil	
mm					kN		min ⁻¹	kg		
20	42	8	0.3	16004	7.90	4.50	0.204	17 000	20 000	0.048
	42	12	0.6	6004	9.38	5.02	0.228	17 000	21 000	0.070
	42	12	0.6	6004RSR	9.38	5.02	0.228	11 000		0.070
	42	12	0.6	6004-2RSR	9.38	5.02	0.228	10 000		0.070
	42	12	0.6	6004ZR	9.38	5.02	0.228	17 000	21 000	0.070
	42	12	0.6	6004-2ZR	9.38	5.02	0.228	17 000		0.070
	47	14	1.0	6204	12.80	6.65	0.302	15 000	17 000	0.108
	47	14	1.0	6204RSR	12.80	6.65	0.302	10 000		0.108
	47	14	1.0	6204-2RSR	12.80	6.65	0.302	10 000		0.108
	47	14	1.0	6204ZR	12.80	6.65	0.302	15 000	17 000	0.108
	47	14	1.0	6204-2ZR	12.80	6.65	0.302	15 000		0.108
	52	15	1.1	6304	15.90	7.88	0.355	14 000	17 000	0.145
	52	15	1.1	6304RSR	15.90	7.88	0.355	9 400		0.145
	52	15	1.1	6304-2RSR	15.90	7.88	0.355	9 400		0.145
	52	15	1.1	6304ZR	15.90	7.88	0.355	14 000	17 000	0.145
	52	15	1.1	6304-2ZR	15.90	7.88	0.355	14 000		0.145
72	19	1.1	6404	31.00	15.20	0.690	11 000	13 000	0.400	
25	47	8	0.3	16005	8.85	5.60	0.254	14 000	17 000	0.053
	47	12	0.6	6005	10.00	5.85	0.266	15 000	18 000	0.082
	47	12	0.6	6005RSR	10.00	5.85	0.266	9 500		0.082
	47	12	0.6	6005-2RSR	10.00	5.85	0.266	9 500		0.082
	47	12	0.6	6005ZR	10.00	5.85	0.266	15 000	18 000	0.082
	47	12	0.6	6005-2ZR	10.00	5.85	0.266	15 000		0.082
	52	15	1.0	6205	14.00	7.88	0.358	13 000	15 000	0.129
	52	15	1.0	6205RSR	14.00	7.88	0.358	8 500		0.129
	52	15	1.0	6205-2RSR	14.00	7.88	0.358	8 500		0.129
	52	15	1.0	6205ZR	14.00	7.88	0.358	13 000	15 000	0.129
	52	15	1.0	6205-2ZR	14.00	7.88	0.358	13 000		0.129
	62	17	1.1	6305	22.40	11.48	0.523	11 000	13 000	0.230
	62	17	1.1	6305RSR	22.40	11.48	0.523	7 500		0.230
	62	17	1.1	6305-2RSR	22.40	11.48	0.523	7 500		0.230
	62	17	1.1	6305ZR	22.40	11.48	0.523	11 000	13 000	0.230
	62	17	1.1	6305-2ZR	22.40	11.48	0.523	11 000		0.230
80	21	1.5	6405	38.20	19.20	0.873	9 400	11 000	0.530	

Single Row Deep Groove Ball Bearings (with Shield or Seals)

d = 30 - 35 mm

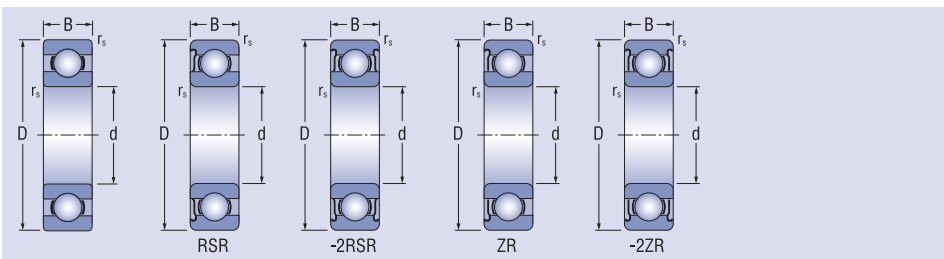

Dimensions				Bearing designation	Basic load rating		Fatigue load limit	Limiting speed for lubrication with		Mass	
d	D	B	r _{s min}		C _r	C _{0r}		grease	oil		
mm								min ⁻¹		kg	
30	55	9	0.3	16006	11.30	7.40	0.336		12 000	14 000	0.087
	55	13	1.1	6006	13.20	8.30	0.377		12 000	15 000	0.119
	55	13	1.1	6006RSR	13.20	8.30	0.377		7 900		0.119
	55	13	1.1	6006-2RSR	13.20	8.30	0.377		7 900		0.119
	55	13	1.1	6006ZR	13.20	8.30	0.377		12 000	15 000	0.119
	55	13	1.1	6006-2ZR	13.20	8.30	0.377		12 000		0.119
	62	16	1.1	6206	19.50	11.30	0.512		11 000	13 000	0.200
	62	16	1.1	6206RSR	19.50	11.30	0.512		7 500		0.200
	62	16	1.1	6206-2RSR	19.50	11.30	0.512		7 500		0.200
	62	16	1.1	6206ZR	19.50	11.30	0.512		11 000	13 000	0.200
	62	16	1.1	6206-2ZR	19.50	11.30	0.512		11 000		0.200
	72	19	1.1	6306	27.00	15.20	0.691		10 000	12 000	0.331
	72	19	1.1	6306RSR	27.00	15.20	0.691		6 700		0.331
	72	19	1.1	6306-2RSR	27.00	15.20	0.691		6 700		0.331
	72	19	1.1	6306ZR	27.00	15.20	0.691		10 000	12 000	0.331
	72	19	1.1	6306-2ZR	27.00	15.20	0.691		10 000		0.331
90	23	1.5	6406	47.50	24.50	1.114		8 400	10 000	0.715	
35	62	9	0.3	16007	12.20	8.85	0.402		11 000	13 000	0.111
	62	14	1.1	6007	16.21	10.42	0.474		10 000	13 000	0.151
	62	14	1.1	6007RSR	16.21	10.42	0.474		7 100		0.151
	62	14	1.1	6007-2RSR	16.21	10.42	0.474		7 100		0.151
	62	14	1.1	6007ZR	16.21	10.42	0.474		10 000	13 000	0.151
	62	14	1.1	6007-2ZR	16.21	10.42	0.474		10 000		0.151
	72	17	1.1	6207	25.70	15.20	0.695		9 400	11 000	0.284
	72	17	1.1	6207RSR	25.70	15.20	0.695		6 300		0.284
	72	17	1.1	6207-2RSR	25.70	15.20	0.695		6 300		0.284
	72	17	1.1	6207ZR	25.70	15.20	0.695		9 400	11 000	0.284
	72	17	1.1	6207-2ZR	25.70	15.20	0.695		9 400		0.284
	80	21	1.7	6307	33.40	19.20	0.873		8 400	10 000	0.447
	80	21	1.7	6307RSR	33.40	19.20	0.873		5 600		0.447
	80	21	1.7	6307-2RSR	33.40	19.20	0.873		5 600		0.447
	80	21	1.7	6307ZR	33.40	19.20	0.873		8 400	10 000	0.447
	80	21	1.7	6307-2ZR	33.40	19.20	0.873		8 400		0.447
100	25	1.5	6407	55.50	29.40	1.336		7 500	8 900	0.954	

Single Row Deep Groove Ball Bearings (with Shield or Seals)

d = 40 - 45 mm

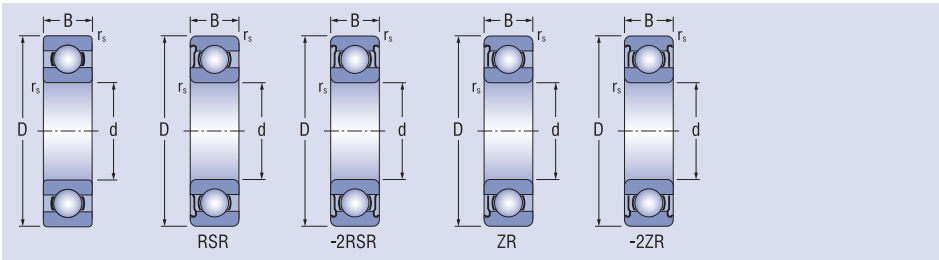

Dimensions				Bearing designation	Basic load rating		Fatigue load limit	Limiting speed for lubrication with		Mass	
d	D	B	r _{s min}		C _r	C _{0r}		grease	oil		
mm								min ⁻¹		kg	
40	68	9	0.3	16008	12.60	9.65	0.439		10 000	12 000	0.125
	68	15	1.1	6008	17.03	11.70	0.532		9 500	12 000	0.187
	68	15	1.1	6008RSR	17.03	11.70	0.532		6 300		0.187
	68	15	1.1	6008-2RSR	17.03	11.70	0.532		6 300		0.187
	68	15	1.1	6008ZR	17.03	11.70	0.532		9 500	12 000	0.187
	68	15	1.1	6008-2ZR	17.03	11.70	0.532		9 500		0.187
	80	18	1.1	6208	29.50	18.10	0.823		8 400	10 000	0.349
	80	18	1.1	6208RSR	29.50	18.10	0.823		5 600		0.349
	80	18	1.1	6208-2RSR	29.50	18.10	0.823		5 600		0.349
	80	18	1.1	6208ZR	29.50	18.10	0.823		8 400	10 000	0.349
	80	18	1.1	6208-2ZR	29.50	18.10	0.823		8 400		0.349
	90	23	1.7	6308	40.75	24.00	1.091		7 500	9 000	0.625
	90	23	1.7	6308RSR	40.75	24.00	1.091		5 300		0.625
	90	23	1.7	6308-2RSR	40.75	24.00	1.091		5 300		0.625
	90	23	1.7	6308ZR	40.75	24.00	1.091		7 500	9 000	0.625
	90	23	1.7	6308-2ZR	40.75	24.00	1.091		7 500		0.625
110	27	2.0	6408	63.50	36.50	1.704		6 700	7 900	1.230	
45	75	10	0.6	16009	15.60	12.20	0.554		9 200	11 000	0.170
	75	16	1.1	6009	21.09	14.77	0.671		9 000	11 000	0.231
	75	16	1.1	6009RSR	21.09	14.77	0.671		5 600		0.231
	75	16	1.1	6009-2RSR	21.09	14.77	0.671		5 600		0.231
	75	16	1.1	6009ZR	21.09	14.77	0.671		9 000	11 000	0.231
	75	16	1.1	6009-2ZR	21.09	14.77	0.671		9 000		0.231
	85	19	1.1	6209	31.70	20.70	0.941		7 500	9 000	0.404
	85	19	1.1	6209RSR	31.70	20.70	0.941		5 300		0.404
	85	19	1.1	6209-2RSR	31.70	20.70	0.941		5 300		0.404
	85	19	1.1	6209ZR	31.70	20.70	0.941		7 500	9 000	0.404
	85	19	1.1	6209-2ZR	31.70	20.70	0.941		7 500		0.404
	100	25	1.7	6309	52.80	31.83	1.447		7 100	8 400	0.828
	100	25	1.7	6309RSR	52.80	31.83	1.447		4 700		0.828
	100	25	1.7	6309-2RSR	52.80	31.83	1.447		4 700		0.828
	100	25	1.7	6309ZR	52.80	31.83	1.447		7 100	8 400	0.828
	100	25	1.7	6309-2ZR	52.80	31.83	1.447		7 100		0.828
120	29	2.0	6409	77.50	45.50	2.068		6 000	7 100	1.540	

Single Row Deep Groove Ball Bearings (with Shield or Seals)

d = 50 - 55 mm

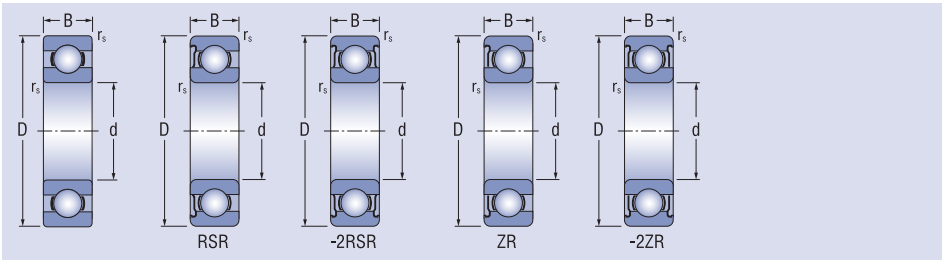

Dimensions				Bearing designation	Basic load rating		Fatigue load limit	Limiting speed for lubrication with		Mass
d	D	B	r _{s min}		C _r	C _{0r}		grease	oil	
mm					kN			min ⁻¹	kg	
50	80	10	0.6	16010	16.10	13.10	0.595	8 400	9 800	0.188
	80	16	1.1	6010	22.00	16.25	0.736	8 500	10 000	0.251
	80	16	1.1	6010RSR	22.00	16.25	0.736	5 300		0.251
	80	16	1.1	6010-2RSR	22.00	16.25	0.736	5 300		0.251
	80	16	1.1	6010ZR	22.00	16.25	0.736	8 500	10 000	0.251
	80	16	1.1	6010-2ZR	22.00	16.25	0.736	8 500		0.251
	90	20	1.1	6210	35.10	23.20	1.054	7 100	8 400	0.460
	90	20	1.1	6210RSR	35.10	23.20	1.054	4 700		0.460
	90	20	1.1	6210-2RSR	35.10	23.20	1.054	4 700		0.460
	90	20	1.1	6210ZR	35.10	23.20	1.054	7 100	8 400	0.460
	90	20	1.1	6210-2ZR	35.10	23.20	1.054	7 100		0.460
	110	27	2.1	6310	61.80	37.90	1.723	6 300	7 500	1.060
	110	27	2.1	6310RSR	61.80	37.90	1.723	4 200		1.060
	110	27	2.1	6310-2RSR	61.80	37.90	1.723	4 200		1.060
	110	27	2.1	6310ZR	61.80	37.90	1.723	6 300	7 500	1.060
	110	27	2.1	6310-2ZR	61.80	37.90	1.723	6 300		1.060
130	31	2.0	6410	92.30	55.10	2.509	5 600	6 700	1.890	
55	90	11	0.6	16011	19.40	16.20	0.736	7 500	9 000	0.260
	90	18	1.1	6011	30.26	22.00	1.000	7 500	9 000	0.381
	90	18	1.1	6011RSR	30.26	22.00	1.000	4 700		0.381
	90	18	1.1	6011-2RSR	30.26	22.00	1.000	4 700		0.381
	90	18	1.1	6011ZR	30.26	22.00	1.000	7 500	9 000	0.381
	90	18	1.1	6011-2ZR	30.26	22.00	1.000	7 500		0.381
	100	21	1.7	6211	43.40	29.20	1.327	6 700	7 900	0.602
	100	21	1.7	6211RSR	43.40	29.20	1.327	4 500		0.602
	100	21	1.7	6211-2RSR	43.40	29.20	1.327	4 500		0.602
	100	21	1.7	6211ZR	43.40	29.20	1.327	6 700	7 900	0.602
	100	21	1.7	6211-2ZR	43.40	29.20	1.327	6 700		0.602
	120	29	2.1	6311	71.60	44.90	2.023	5 600	6 700	1.380
	120	29	2.1	6311RSR	71.60	44.90	2.023	3 800		1.380
	120	29	2.1	6311-2RSR	71.60	44.90	2.023	3 800		1.380
	120	29	2.1	6311ZR	71.60	44.90	2.023	5 600	6 700	1.380
	120	29	2.1	6311-2ZR	71.60	44.90	2.023	5 600		1.380
	140	33	2.1	6411	100.70	62.50	2.841	5 300	6 300	2.290

Single Row Deep Groove Ball Bearings (with Shield or Seals)

d = 60 - 65 mm

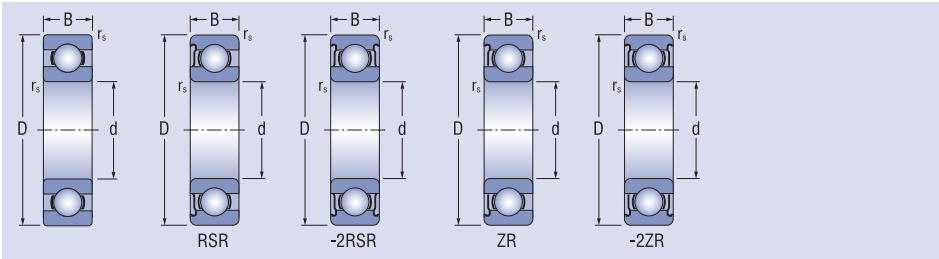

Dimensions				Bearing designation	Basic load rating		Fatigue load limit	Limiting speed for lubrication with		Mass
d	D	B	r _{s min}		C _r	C _{0r}		grease	oil	
mm								min ⁻¹		kg
60	95	11	0.6	16012	19.90	17.50	0.854	7 100	8 300	0.280
	95	18	1.1	6012	31.66	24.22	1.101	6 700	8 000	0.411
	95	18	1.1	6012RSR	31.66	24.22	1.101	4 500		0.411
	95	18	1.1	6012-2RSR	31.66	24.22	1.101	4 500		0.411
	95	18	1.1	6012ZR	31.66	24.22	1.101	6 700	8 000	0.411
	95	18	1.1	6012-2ZR	31.66	24.22	1.101	6 700		0.411
	110	22	1.7	6212	47.80	32.90	1.495	6 000	7 100	0.783
	110	22	1.7	6212RSR	47.80	32.90	1.495	4 000		0.783
	110	22	1.7	6212-2RSR	47.80	32.90	1.495	4 000		0.783
	110	22	1.7	6212ZR	47.80	32.90	1.495	6 000	7 100	0.783
	110	22	1.7	6212-2ZR	47.80	32.90	1.495	6 000		0.783
	130	31	2.1	6312	81.80	51.80	2.354	5 300	6 300	1.720
	130	31	2.1	6312RSR	81.80	51.80	2.354	3 500		1.720
	130	31	2.1	6312-2RSR	81.80	51.80	2.354	3 500		1.720
	130	31	2.1	6312ZR	81.80	51.80	2.354	5 300	6 300	1.720
130	31	2.1	6312-2ZR	81.80	51.80	2.354	5 300		1.720	
150	35	2.1	6412	109.10	70.10	3.115	4 700	5 600	2.780	
65	100	11	0.6	16013	20.45	18.65	0.891	6 500	7 700	0.300
	100	18	1.1	6013	32.07	24.90	1.141	6 300	7 500	0.446
	100	18	1.1	6013RSR	32.07	24.90	1.141	4 200		0.455
	100	18	1.1	6013-2RSR	32.07	24.90	1.141	4 200		0.464
	100	18	1.1	6013ZR	32.07	24.90	1.141	6 300	7 500	0.455
	100	18	1.1	6013-2ZR	32.07	24.90	1.141	6 300		0.464
	120	23	1.7	6213	57.20	40.00	1.886	5 300	6 300	1.000
	120	23	1.7	6213RSR	57.20	40.00	1.886	3 500		1.015
	120	23	1.7	6213-2RSR	57.20	40.00	1.886	3 500		1.030
	120	23	1.7	6213ZR	57.20	40.00	1.886	5 300	6 300	1.015
	120	23	1.7	6213-2ZR	57.20	40.00	1.886	5 300		1.030
	140	33	2.1	6313	93.00	60.00	2.703	5 000	6 000	2.140
	140	33	2.1	6313RSR	93.00	60.00	2.703	3 300		2.160
	140	33	2.1	6313-2RSR	93.00	60.00	2.703	3 300		2.180
	140	33	2.1	6313ZR	93.00	60.00	2.703	5 000	6 000	2.160
	140	33	2.1	6313-2ZR	93.00	60.00	2.703	5 000		2.180
	160	37	2.1	6413	118.10	78.60	3.283	4 500	5 300	3.490

Single Row Deep Groove Ball Bearings (with Shield or Seals)

d = 70 - 75 mm

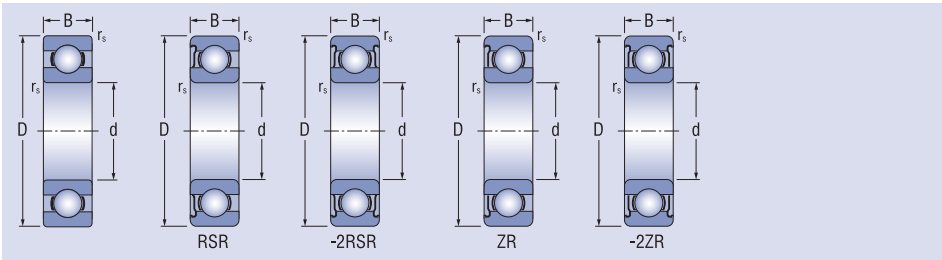

Dimensions				Bearing designation	Basic load rating		Fatigue load limit	Limiting speed for lubrication with		Mass
d	D	B	r _{s min}		C _r	C _{0r}		grease	oil	
mm								min ⁻¹		kg
70	110	13	0.6	16014	27.90	25.00	1.136	6 300	7 200	0.438
	110	20	1.1	6014	38.60	30.43	1.409	5 600	6 700	0.622
	110	20	1.1	6014RSR	38.60	30.43	1.409	3 800		0.630
	110	20	1.1	6014-2RSR	38.60	30.43	1.409	3 800		0.640
	110	20	1.1	6014ZR	38.60	30.43	1.409	5 600	6 700	0.630
	110	20	1.1	6014-2ZR	38.60	30.43	1.409	5 600		0.640
	125	24	1.7	6214	60.80	45.00	2.000	5 300	6 300	1.090
	125	24	1.7	6214RSR	60.80	45.00	2.000	3 500		1.000
	125	24	1.7	6214-2RSR	60.80	45.00	2.000	3 500		1.010
	125	24	1.7	6214ZR	60.80	45.00	2.000	5 300	6 300	1.000
	125	24	1.7	6214-2ZR	60.80	45.00	2.000	5 300		1.010
	150	35	2.1	6314	104.10	68.00	2.956	4 700	5 600	2.610
	150	35	2.1	6314RSR	104.10	68.00	2.956	3 200		2.635
	150	35	2.1	6314-2RSR	104.10	68.00	2.956	3 200		2.660
	150	35	2.1	6314ZR	104.10	68.00	2.956	4 700	5 600	2.635
	150	35	2.1	6314-2ZR	104.10	68.00	2.956	4 700		2.660
180	42	3.0	6414	136.30	96.50	3.923	4 000	4 700	5.060	
75	115	13	0.6	16015	28.70	26.80	1.220	5 700	6 700	0.463
	115	20	1.1	6015	40.20	33.20	1.523	5 300	6 300	0.654
	115	20	1.1	6015RSR	40.20	33.20	1.523	3 500		0.666
	115	20	1.1	6015-2RSR	40.20	33.20	1.523	3 500		0.678
	115	20	1.1	6015ZR	40.20	33.20	1.523	5 300	6 300	0.666
	115	20	1.1	6015-2ZR	40.20	33.20	1.523	5 300		0.678
	130	25	1.7	6215	66.10	49.50	2.197	5 000	6 000	1.180
	130	25	1.7	6215RSR	66.10	49.50	2.197	3 300		1.195
	130	25	1.7	6215-2RSR	66.10	49.50	2.197	3 300		1.210
	130	25	1.7	6215ZR	66.10	49.50	2.197	5 000	6 000	1.195
	130	25	1.7	6215-2ZR	66.10	49.50	2.197	5 000		1.210
	160	37	2.1	6315	113.40	77.00	3.214	4 200	5 000	3.180
	160	37	2.1	6315RSR	113.40	77.00	3.214	3 100		3.205
	160	37	2.1	6315-2RSR	113.40	77.00	3.214	3 100		3.230
	160	37	2.1	6315ZR	113.40	77.00	3.214	4 200	5 000	3.205
	160	37	2.1	6315-2ZR	113.40	77.00	3.214	4 200		3.230
	190	45	3.0	6415	153.80	114.30	4.459	3 800	4 500	7.000

Single Row Deep Groove Ball Bearings (with Shield or Seals)

d = 80 - 85 mm

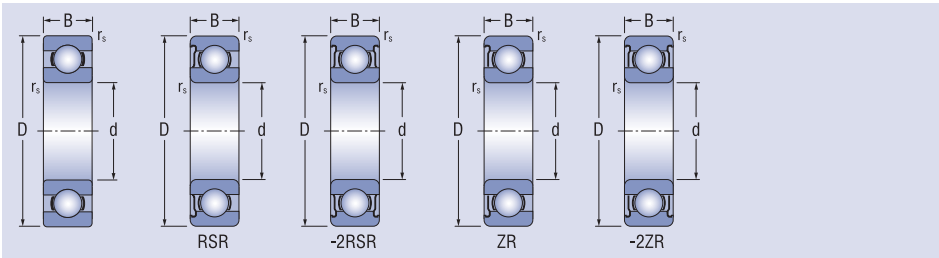

Dimensions				Bearing designation	Basic load rating		Fatigue load limit	Limiting speed for lubrication with		Mass
d	D	B	r _{s min}		C _r	C _{0r}		grease	oil	
mm					kN		min ⁻¹	kg		
80	125	14	0.6	16016	33.10	31.40	1.393	5 300	6 200	0.609
	125	22	1.1	6016	47.54	39.80	1.796	5 000	6 000	0.867
	125	22	1.1	6016RSR	47.54	39.80	1.796	3 300		0.880
	125	22	1.1	6016-2RSR	47.54	39.80	1.796	3 300		0.893
	125	22	1.1	6016ZR	47.54	39.80	1.796	5 000	6 000	0.880
	125	22	1.1	6016-2ZR	47.54	39.80	1.796	5 000		0.893
	140	28	2.1	6216	71.55	54.25	2.297	4 700	5 600	1.460
	140	28	2.1	6216RSR	71.55	54.25	2.297	3 200		1.475
	140	28	2.1	6216-2RSR	71.55	54.25	2.297	3 200		1.490
	140	28	2.1	6216ZR	71.55	54.25	2.297	4 700	5 600	1.475
	140	28	2.1	6216-2ZR	71.55	54.25	2.297	4 700		1.490
	170	39	2.1	6316	130.00	86.50	3.516	4 000	4 700	3.750
	170	39	2.1	6316RSR	130.00	86.50	3.516	2 700		3.785
	170	39	2.1	6316-2RSR	130.00	86.50	3.516	2 700		3.820
	170	39	2.1	6316ZR	130.00	86.50	3.516	4 000	4 700	3.785
	170	39	2.1	6316-2ZR	130.00	86.50	3.516	4 000	4 700	3.820
200	48	3.0	6416	163.00	125.00	4.802	3 500	4 200	6.700	
85	130	14	0.6	16017	34.00	33.30	1.469	5 000	5 900	0.666
	130	22	1.1	6017	52.70	44.60	1.955	4 700	5 600	0.916
	130	22	1.1	6017RSR	52.70	44.60	1.955	3 200		0.928
	130	22	1.1	6017-2RSR	52.70	44.60	1.955	3 200		0.940
	130	22	1.1	6017ZR	52.70	44.60	1.955	4 700	5 600	0.928
	130	22	1.1	6017-2ZR	52.70	44.60	1.955	4 700		0.940
	150	28	2.1	6217	83.20	64.00	2.683	4 200	5 000	1.870
	150	28	2.1	6217RSR	83.20	64.00	2.683	2 800		1.890
	150	28	2.1	6217-2RSR	83.20	64.00	2.683	2 800		1.910
	150	28	2.1	6217ZR	83.20	64.00	2.683	4 200	5 000	1.890
	150	28	2.1	6217-2ZR	83.20	64.00	2.683	4 200		1.910
	180	41	4.0	6317	132.70	96.60	3.811	3 800	4 500	4.250
	180	41	4.0	6317RSR	132.70	96.60	3.811	2 500		4.290
	180	41	4.0	6317-2RSR	132.70	96.60	3.811	2 500		4.330
	180	41	4.0	6317ZR	132.70	96.60	3.811	3 800	4 500	4.290
	180	41	4.0	6317-2ZR	132.70	96.60	3.811	2 500		4.330
210	52	4.0	6417	173.00	137.00	5.127	3 300	4 000	7.900	

Single Row Deep Groove Ball Bearings (with Shield or Seals)

d = 90 - 95 mm

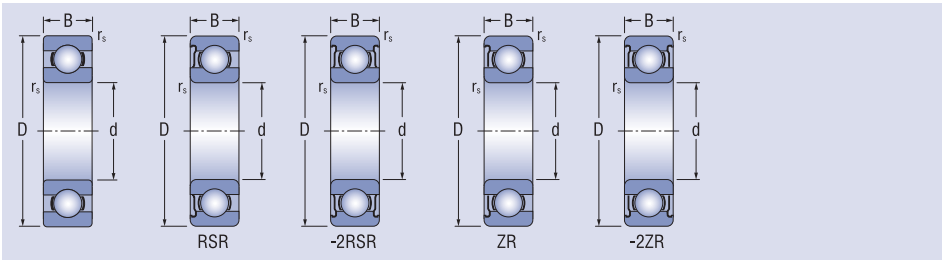

Dimensions				Bearing designation	Basic load rating		Fatigue load limit	Limiting speed for lubrication with		Mass
d	D	B	r _{s min}		C _r	C _{0r}		grease	oil	
mm								min ⁻¹		kg
90	140	16	1.0	16018	41.50	39.30	1.560	4 700	5 600	0.866
	140	24	1.7	6018	58.00	49.80	2.119	4 500	5 300	1.210
	140	24	1.7	6018RSR	58.00	49.80	2.119	3 000		1.220
	140	24	1.7	6018-2RSR	58.00	49.80	2.119	3 000		1.230
	140	24	1.7	6018ZR	58.00	49.80	2.119	4 500	5 300	1.220
	140	24	1.7	6018-2ZR	58.00	49.80	2.119	4 500		1.230
	160	30	2.0	6218	96.00	71.50	2.937	4 000	4 700	2.210
	160	30	2.0	6218RSR	96.00	71.50	2.937	2 500		2.235
	160	30	2.0	6218-2RSR	96.00	71.50	2.937	2 500		2.260
	160	30	2.0	6218ZR	96.00	71.50	2.937	4 000	4 700	2.235
	160	30	2.0	6218-2ZR	96.00	71.50	2.937	4 000		2.260
	190	43	3.0	6318	144.00	108.50	3.923	3 500	4 200	5.430
	190	43	3.0	6318RSR	144.00	108.50	3.923	2 300		5.480
	190	43	3.0	6318-2RSR	144.00	108.50	3.923	2 300		5.530
	190	43	3.0	6318ZR	144.00	108.50	3.923	3 500	4 200	5.480
	190	43	3.0	6318-2ZR	144.00	108.50	3.923	2 300		5.530
	225	54	4.0	6418	196.00	163.00	5.903	3 200	3 800	11.400
95	145	16	1.0	16019	42.80	41.90	1.660	4 500	5 300	0.922
	145	24	1.7	6019	57.80	50.10	2.241	4 200	5 000	1.270
	145	24	1.7	6019RSR	57.80	50.10	2.241	2 800		1.295
	145	24	1.7	6019-2RSR	57.80	50.10	2.241	2 800		1.320
	145	24	1.7	6019ZR	57.80	50.10	2.241	4 200	5 000	1.295
	145	24	1.7	6019-2ZR	57.80	50.10	2.241	4 200		1.320
	170	32	2.1	6219	110.30	82.80	3.219	3 800	4 500	2.730
	170	32	2.1	6219RSR	110.30	82.80	3.219	2 300		2.760
	170	32	2.1	6219-2RSR	110.30	82.80	3.219	2 300		7.790
	170	32	2.1	6219ZR	110.30	82.80	3.219	3 800	4 500	2.760
	170	32	2.1	6219-2ZR	110.30	82.80	3.219	3 800		2.790
	200	45	3.0	6319	153.00	119.00	4.195	3 300	4 000	6.230
	200	45	3.0	6319RSR	153.00	119.00	4.195	2 100		6.285
	200	45	3.0	6319-2RSR	153.00	119.00	4.195	2 100		6.340
	200	45	3.0	6319ZR	153.00	119.00	4.195	3 300	4 000	6.285
200	45	3.0	6319-2ZR	153.00	119.00	4.195	3 300		6.340	

Single Row Deep Groove Ball Bearings (with Shield or Seals)

d = 100 - 150 mm

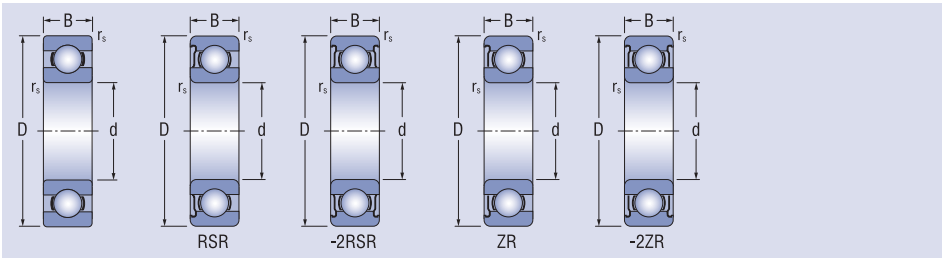

Dimensions				Bearing designation	Basic load rating		Fatigue load limit	Limiting speed for lubrication with		Mass
d	D	B	r _{s min}		C _r	C _{0r}		grease	oil	
mm					kN		C _u	min ⁻¹	kg	
100	150	16	1.0	16020	43.80	44.30	1.789	4 200	5 000	0.956
	150	24	1.7	6020	64.50	56.10	2.195	4 200	5 000	1.320
	150	24	1.7	6020RSR	64.50	56.10	2.195	2 800		1.335
	150	24	1.7	6020-2RSR	64.50	56.10	2.195	2 800		1.350
	150	24	1.7	6020ZR	64.50	56.10	2.195	4 200	5 000	1.335
	150	24	1.7	6020-2ZR	64.50	56.10	2.195	4 200		1.350
	180	34	2.1	6220	122.10	92.70	3.577	3 500	4 200	3.300
	180	34	2.1	6220RSR	122.10	92.70	3.577	2 100		3.330
	180	34	2.1	6220-2RSR	122.10	92.70	3.577	2 100		3.360
	180	34	2.1	6220ZR	122.10	92.70	3.577	3 500	4 200	3.330
	180	34	2.1	6220-2ZR	122.10	92.70	3.577	3 500		3.360
	215	47	3.0	6320	173.00	140.40	4.855	3 200	3 800	7.670
	215	47	3.0	6320RSR	173.00	140.40	4.855	1 800		7.725
	215	47	3.0	6320-2RSR	173.00	140.40	4.855	1 800		7.780
	215	47	3.0	6320ZR	173.00	140.40	4.855	3 200	3 800	7.725
	215	47	3.0	6320-2ZR	173.00	140.40	4.855	3 200		7.780
105	160	18	1.0	16021	54.00	54.00	1.971	4 000	4 700	1.240
	160	26	2.1	6021	71.90	63.30	2.526	4 000	4 700	1.670
	190	36	2.1	6221	133.00	104.50	3.895	3 300	4 000	3.880
	225	49	3.0	6321	184.00	154.00	5.166	3 000	3 500	8.700
110	170	19	1.0	16022	57.40	56.70	2.192	3 800	4 500	1.510
	170	28	2.1	6022	81.90	72.90	2.731	3 800	4 500	2.060
	200	38	2.1	6222	144.10	117.00	4.237	3 200	3 800	4.640
	240	50	3.0	6322	205.00	178.00	6.047	2 800	3 300	9.550
120	180	19	1.0	16024	58.80	60.40	2.375	3 300	4 000	1.620
	180	28	2.1	6024	87.70	79.35	2.895	3 300	4 000	2.180
	215	40	2.1	6224	155.30	131.00	4.600	3 000	3 500	5.620
	260	55	3.0	6324	228.00	207.00	6.247	2 500	3 000	12.500
130	200	22	1.1	16026	78.00	81.50	2.700	3 200	3 800	2.410
	200	33	2.1	6026	105.10	96.80	3.538	3 200	3 800	3.340
	230	40	3.0	6226	165.60	147.80	5.007	2 800	3 300	6.240
	280	58	4.0	6326	228.00	216.00	6.857	2 400	2 800	14.700
140	210	22	1.1	16028	81.00	86.50	2.800	3 000	3 600	2.550
	210	33	2.1	6028	116.30	108.50	3.711	3 000	3 500	3.570
	250	42	3.0	6228	179.10	166.90	5.407	2 500	3 000	8.070
	300	62	4.0	6328	253.00	246.00	7.538	2 200	2 700	18.500
150	225	24	1.1	16030	91.50	98.00	3.050	2 600	3 200	3.170
	225	35	2.1	6030	131.70	124.55	4.150	2 600	3 200	4.380
	270	45	3.0	6230	203.20	199.00	6.241	2 200	2 700	10.300
	320	65	4.0	6330	277.00	280.00	8.302	2 000	2 500	21.400

Single Row Deep Groove Ball Bearings (with Shield or Seals)

d = 160 - 400 mm

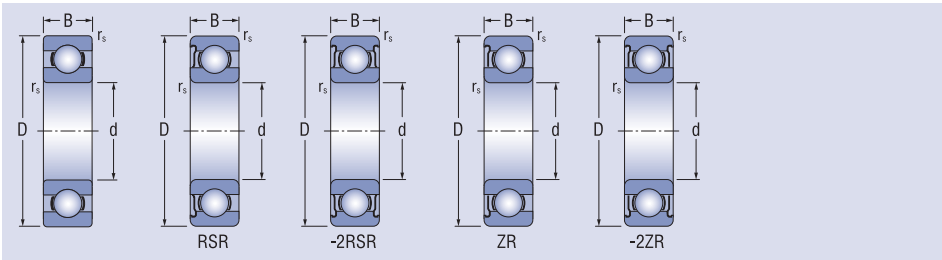

Dimensions				Bearing designation	Basic load rating		Fatigue load limit	Limiting speed for lubrication with		Mass
d	D	B	r _{s min}		C _r	C _{0r}		grease	oil	
mm					kN			min ⁻¹	kg	
160	240	25	1.5	16032	98.70	107.50	3.430	2 400	3 000	3.700
	240	38	2.1	6032M	143.40	138.00	4.120	2 400	3 000	6.160
	290	48	3.0	6232	202.00	202.00	6.121	2 100	2 500	12.500
	340	68	4.0	6332	309.00	327.00	9.400	1 800	2 200	26.650
170	260	28	1.5	16034	119.00	129.00	4.000	2 200	2 800	5.000
	260	42	2.1	6034M	170.20	171.10	53.303	2 200	2 700	7.130
	310	52	4.0	6234	228.00	240.00	7.041	1 900	2 400	15.200
	360	72	4.0	6334	350.00	380.00	10.610	1 700	2 000	30.900
180	280	31	2.0	16036	138.00	146.00	4.376	2 100	2 600	6.600
	280	46	2.1	6036	188.00	198.00	5.934	2 100	2 500	8.510
	320	52	4.0	6236	242.00	260.00	7.474	1 800	2 200	15.400
190	290	31	2.0	16038	149.00	167.00	4.870	2 000	2 500	7.900
	290	46	2.1	6038	196.00	215.00	6.308	2 000	2 400	8.860
	340	55	4.0	6238	270.00	301.00	8.404	1 700	2 000	18.900
200	310	34	2.1	16040	167.40	190.40	5.408	1 900	2 400	8.850
	310	51	2.1	6040	205.00	225.00	6.404	1 900	2 200	11.640
	360	58	4.0	6240	283.00	324.00	8.910	1 600	1 900	22.600
220	340	37	2.1	16044	181.00	216.00	5.867	1 800	2 200	11.500
	340	56	3.0	6044M	245.00	290.00	7.877	1 800	2 100	18.000
	400	65	4.0	6244M	297.00	365.00	9.423	1 500	1 800	31.200
240	360	37	2.1	16048	202.00	254.00	6.692	1 700	2 100	14.500
	360	56	3.0	6048M	244.20	296.00	7.768	1 700	2 000	20.000
	440	72	4.0	6248M	360.00	470.00	11.586	1 300	1 600	51.800
260	400	44	3.0	16052	236.00	310.00	7.757	1 500	1 800	21.500
	400	65	4.0	6052M	293.00	375.00	9.308	1 500	1 800	28.200
	480	80	5.0	6252M	430.00	590.00	13.942	1 200	1 500	68.800
280	420	44	3.0	16056M	240.00	325.00	8.017	1 500	1 800	23.000
	420	65	4.0	6056M	305.00	408.00	9.913	1 500	1 800	32.100
	500	80	5.0	6256M	425.00	600.00	13.810	1 100	1 400	70.400
300	460	50	4.0	16060M	285.00	404.00	9.327	1 200	1 500	31.500
	460	74	4.0	6060M	338.00	475.00	11.076	1 200	1 500	42.400
320	480	50	4.0	16064M	293.00	430.00	9.861	1 100	1 400	34.000
	480	74	4.0	6064M	345.00	510.00	11.591	1 100	1 400	46.510
340	520	57	4.0	16068M	345.00	515.00	11.398	1 000	1 300	46.000
	520	82	5.0	6068M	390.00	580.00	12.713	1 000	1 300	61.200
360	540	57	4.0	16072M	345.00	540.00	11.570	1 000	1 300	50.000
	540	82	5.0	6072M	400.00	622.00	13.327	1 000	1 300	68.000
380	560	57	4.0	16076M	375.00	620.00	12.894	950	1 200	50.500
	560	82	5.0	6076M	436.00	695.00	13.900	950	1 200	79.000
400	600	90	5.0	6080M	520.00	865.00	17.644	850	1 100	89.400

Single Row Deep Groove Ball Bearings with Snap Ring Groove on Outer Ring

d = 17 - 60 mm

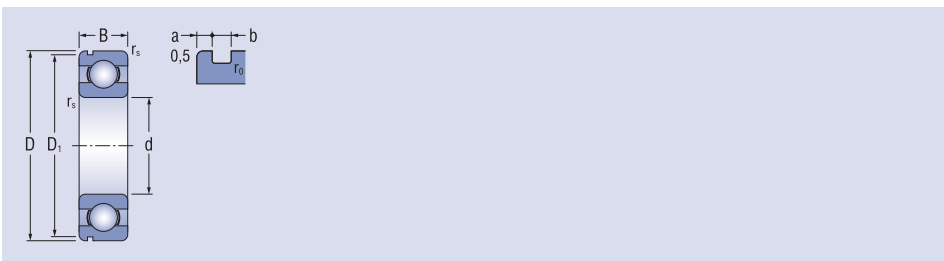

Dimensions								Bearing designation	Basic load rating		Fatigue load limit	Limiting speed for lubrication with		Mass
d	D	B	rs min	D1 max	a max	b min	r0 max		dynamic	static		grease	oil	
mm								Cr	Cor	Cu		min ⁻¹	kg	
17	35	10	0.3	33.17	2.06	1.35	0.4	6003N	6.00	3.25	0.148	21 000	25 000	0.040
	40	12	0.6	38.10	2.06	1.35	0.4	6203N	9.58	4.78	0.217	17 000	21 000	0.073
	47	14	1	44.60	2.46	1.35	0.4	6303N	13.56	6.56	0.298	16 000	19 000	0.115
20	42	12	0.6	39.75	2.06	1.35	0.4	6004N	9.38	5.02	0.228	17 000	21 000	0.070
	47	14	1	44.60	2.46	1.35	0.4	6204N	12.80	6.65	0.302	15 000	17 000	0.108
	52	15	1.1	49.73	2.46	1.35	0.4	6304N	15.87	7.81	0.355	14 000	17 000	0.145
25	47	12	0.6	44.60	2.06	1.35	0.4	6005N	10.00	5.85	0.266	15 000	18 000	0.082
	52	15	1	49.73	2.46	1.35	0.4	6205N	14.00	7.88	0.358	13 000	15 000	0.129
	62	17	1.1	59.61	3.28	1.90	0.6	6305N	22.40	11.48	0.523	11 000	13 000	0.230
	80	21	1.5	76.81	3.28	1.90	0.6	6405N	38.20	19.20	0.873	9 400	11 000	0.530
30	55	13	1.1	52.60	2.08	1.90	0.4	6006N	13.20	8.30	0.377	12 000	14 000	0.119
	62	16	1.1	59.61	3.28	1.90	0.6	6206N	19.40	11.20	0.509	11 000	13 000	0.200
	72	19	1.1	68.81	3.28	1.90	0.6	6306N	27.00	15.20	0.691	10 000	12 000	0.331
	90	23	1.5	86.79	3.28	2.70	0.6	6406N	47.50	24.50	1.114	8 400	10 000	0.715
35	62	14	1.1	59.61	2.06	1.90	0.6	6007N	16.21	10.42	0.474	10 000	13 000	0.154
	72	17	1.1	68.81	3.28	1.90	0.6	6207N	25.70	15.30	0.695	9 400	11 000	0.284
	80	21	1.7	78.81	3.28	1.90	0.6	6307N	33.40	19.20	0.873	8 400	10 000	0.447
	100	25	1.5	96.80	3.28	2.70	0.6	6407N	56.80	29.60	1.345	7 500	8 900	0.954
40	68	15	1.1	64.82	2.49	1.90	0.6	6008N	17.03	11.70	0.532	9 500	12 000	0.191
	80	18	1.1	76.81	3.28	1.90	0.6	6208N	29.50	18.10	0.823	8 400	10 000	0.349
	90	23	1.7	86.79	3.28	2.70	0.6	6308N	40.75	24.00	1.091	7 500	9 000	0.625
	110	27	2.0	106.81	3.28	2.70	0.6	6408N	65.50	37.60	1.709	6 700	7 900	1.230
45	75	16	1.1	71.83	2.49	1.90	0.6	6009N	21.09	14.77	0.671	9 000	11 000	0.241
	85	19	1.1	81.81	3.28	1.90	0.6	6209N	31.70	20.70	0.941	7 500	9 000	0.404
	100	25	1.7	96.80	3.28	2.70	0.6	6309N	52.80	31.83	1.447	7 100	8 400	0.828
	120	29	2.0	115.21	4.06	3.10	0.6	6409N	77.50	45.50	2.068	6 000	7 100	1.540
50	80	16	1.1	76.81	2.49	1.90	0.6	6010N	22.00	16.20	0.736	8 500	10 000	0.260
	90	20	1.1	86.79	3.28	2.70	0.6	6210N	35.10	23.20	1.054	7 100	8 400	0.460
	110	27	2.1	106.81	3.28	2.70	0.6	6310N	61.80	37.90	1.723	6 300	7 500	1.060
	130	31	2.0	125.22	4.06	3.10	0.6	6410N	92.20	55.20	2.509	5 600	6 700	1.890
55	90	18	1.1	86.79	2.87	2.70	0.6	6011N	30.30	22.00	1.000	7 500	9 000	0.383
	100	21	1.7	96.80	3.28	2.70	0.6	6211N	43.40	29.20	1.327	6 700	7 900	0.602
	120	29	2.1	115.21	4.06	3.10	0.6	6311N	71.50	44.50	2.023	5 600	6 700	1.380
	140	33	2.1	135.23	4.90	3.10	0.6	6411N	100.70	62.50	2.841	5 300	6 300	2.290
60	95	18	1.1	91.82	2.87	2.70	0.6	6012N	31.66	24.22	1.101	6 700	8 000	0.411
	110	22	1.7	106.81	3.82	2.70	0.6	6212N	47.80	32.90	1.495	6 000	7 100	0.783
	130	31	2.1	125.22	4.06	3.10	0.6	6312N	81.80	51.80	2.354	5 300	6 300	1.720
	150	35	2.1	145.24	4.90	3.10	0.6	6412N	109.00	70.10	3.115	4 700	5 600	2.780

Single Row Deep Groove Ball Bearings with Snap Ring Groove on Outer Ring

d = 60 - 90 mm

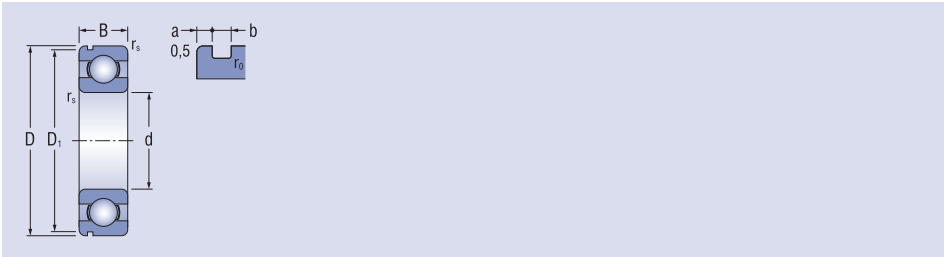

Dimensions								Bearing designation	Basic load rating		Fatigue load limit	Limiting speed for lubrication with		Mass
d	D	B	rs min	D1 max	a max	b min	r0 max		dynamic	static		grease	oil	
mm								Cr	Cor	Cu		min ⁻¹	kg	
65	100	18	1.1	96.80	2.87	2.70	0.6	6013N	32.10	24.90	1.131	6 300	7 500	0.437
	120	23	1.7	115.21	4.06	3.10	0.6	6213N	57.20	40.00	1.818	5 300	6 300	0.997
	140	33	2.1	135.23	4.90	3.10	0.6	6313N	93.90	60.50	2.703	5 000	6 000	2.100
	160	37	2.1	155.22	4.90	3.10	0.6	6413N	118.10	78.60	3.361	4 500	5 300	3.280
70	110	20	1.1	106.81	2.87	2.70	0.6	6014N	38.00	31.00	1.409	5 600	6 700	0.604
	125	24	1.7	120.22	4.06	3.10	0.6	6214N	62.00	44.00	2.000	5 300	6 300	1.090
	150	35	2.1	145.24	4.90	3.10	0.6	6314N	104.00	68.00	2.956	4 700	5 600	2.540
	180	42	3.0	173.66	5.69	3.50	0.6	6414N	139.50	99.50	4.029	4 000	4 700	4.850
75	115	20	1.1	111.81	2.87	2.70	0.6	6015N	39.00	33.50	1.523	5 300	6 300	0.640
	130	25	1.7	125.22	4.06	3.10	0.6	6215N	65.50	49.00	2.197	5 000	6 000	1.180
	160	37	2.1	155.22	4.90	3.10	0.6	6315N	114.00	76.50	3.214	4 200	5 000	3.060
	190	45	3.0	183.64	5.69	3.10	0.6	6415N	153.80	114.30	4.488	3 800	4 500	5.740
80	125	22	1.1	120.22	2.87	3.10	0.6	6016N	47.50	40.00	1.796	5 000	6 000	0.872
	140	28	2.1	135.23	4.90	3.10	0.6	6216N	72.00	53.00	2.297	4 700	5 600	1.400
	170	39	2.1	163.65	5.69	3.50	0.6	6316N	130.00	86.50	3.516	4 000	4 700	3.642
85	130	22	1.1	125.22	2.87	3.10	0.6	6017N	50.80	43.00	1.886	4 700	5 600	0.918
	150	28	2.1	145.24	4.90	3.10	0.6	6217N	83.00	64.00	2.683	4 200	5 000	1.800
	180	41	4	173.66	5.69	3.50	0.6	6317N	140.00	96.50	3.811	3 800	4 500	4.250
90	140	24	1.7	135.23	3.71	3.10	0.6	6018N	58.50	50.00	2.075	4 500	5 300	1.200
	160	30	2	155.22	4.90	3.10	0.6	6218N	96.50	72.00	2.937	4 000	4 700	2.160
	190	43	3	183.64	5.69	3.50	0.6	6318N	143.00	107.20	4.118	3 500	4 200	4.980

Single Row Deep Groove Ball Bearings - Separable

d = 4 - 20 mm

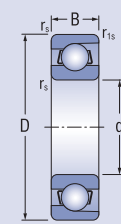

Dimensions					Bearing designation	Basic load rating		Fatigue load limit	Limiting speed for lubrication with		Mass	
d	D	B	r _s min	r _{1s} min		C _r	C _{0r}		C _u	grease		oil
mm						kN			min ⁻¹		kg	
4	16	5	0.15	0.10	E4	1.22	0.24	0.011		34 000	40 000	0.005
5	16	5	0.15	0.10	E5	1.34	0.28	0.012		34 000	40 000	0.005
6	21	7	0.30	0.15	E6	2.24	0.40	0.018		30 000	36 000	0.011
7	22	7	0.30	0.15	E7	3.24	0.44	0.020		30 000	36 000	0.013
8	24	7	0.30	0.15	E8	3.24	0.44	0.020		28 000	34 000	0.016
9	28	8	0.30	0.15	E9	4.24	0.88	0.040		24 000	30 000	0.024
10	28	8	0.30	0.15	E10	4.24	0.88	0.040		24 000	30 000	0.023
11	32	7	0.30	0.15	E11	3.43	0.58	0.026		22 000	28 000	0.028
12	32	7	0.30	0.15	E12	3.43	0.58	0.026		22 000	28 000	0.027
13	30	7	0.30	0.15	E13	3.43	0.58	0.026		22 000	28 000	0.025
15	35	8	0.30	0.15	E15	4.52	1.15	0.048		19 000	24 000	0.034
17	44	11	0.60	0.30	E17	5.75	1.50	0.068		14 000	18 000	0.079
17	44	11	0.60	0.30	B017	5.75	1.50	0.068		14 000	17 000	0.075
20	47	12	0.60	0.30	E20	8.95	2.38	0.108		14 000	17 000	0.089



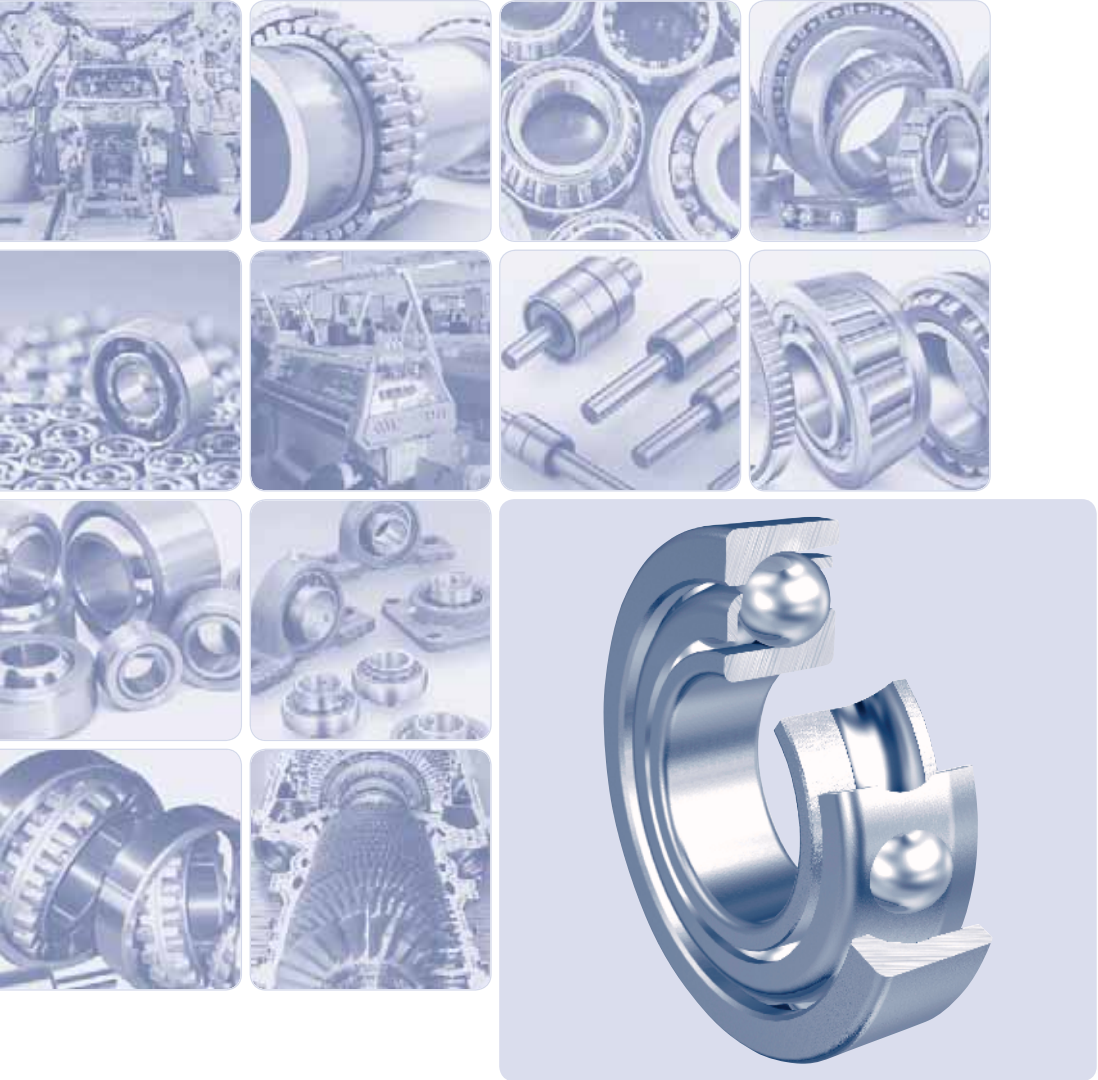

Single Row Angular Contact Ball Bearings

Single Row Angular Contact Ball Bearings

Single Row Angular Contact Ball Bearings

The raceways of the single row angular contact ball bearings are in such position, that the connecting line of their contact points with the balls form an acute angle with the perpendicular line to the bearing axis, or contact angle. Bearings of design B have a contact angle $\alpha = 40^\circ$ and have a high number of balls with good conformability which ensures their high load rating. They can carry radial loads acting simultaneously with high axial forces in one direction. Bearings are arranged in pairs so that axial guiding in both direction can be achieved.

Single row angular contact ball bearings of the design AA with a contact angle of $\alpha = 26^\circ$ are used in applications with a higher axial load.

Bearings of the design B and AA are non-separable, although both rings have only one rib.

Boundary dimensions

The boundary dimensions of the single row angular contact ball bearings indicated in the dimension tables, correspond to the international dimensional standard ISO 15.

Designation

The bearing designation in the standard design is shown in the dimension tables. Differences from the standard design are designated by additional symbols according to STN 02 4608.

Cage

The single row angular contact ball bearings have a pressed steel cage which is not marked.

For special applications some bearings are manufactured with a polyamide cage (TNG). Deliveries of bearings with this cage need to be discussed in advance.

Accuracy

The single row angular contact ball bearings are commonly manufactured with the normal tolerance class P0 (the symbol is not indicated). For special applications requiring a high accuracy or for higher rotational speeds, the bearings are supplied in the higher tolerance class P6. Limiting deviation values of the dimension and running accuracy are indicated in ISO 492.

Inner clearance

The single row angular contact ball bearings are usually mounted in pairs. The suitable operating clearance or preload is adjusted during mounting and depends on the arrangement design and operating conditions.

Misalignment

The single row angular contact ball bearings mounted in pairs are sensitive to the misalignment of bearing rings. Misalignment causes additional load on the bearings, which shortens their lifetime.

Radial Equivalent Dynamic and Static Load

Radial Equivalent Dynamic Load

The single row angular contact ball bearings with contact angle $\alpha = 40^\circ$ (B)

$$\begin{array}{ll} P_r = F_r & \text{pre } F_a/F_r \leq 1,14 \\ P_r = 0,35 + 0,57F_a & \text{pre } F_a/F_r > 1,14 \end{array}$$

The single row angular contact ball bearings with contact angle $\alpha = 26^\circ$ (AA)

$$\begin{array}{ll} P_r = F_r & \text{pre } F_a/F_r \leq 0,68 \\ P_r = 0,41F_r + 0,87F_a & \text{pre } F_a/F_r > 0,68 \end{array}$$

Radial Equivalent Static Load

The single row angular contact ball bearings with contact angle $\alpha = 40^\circ$ (B)

$$P_{or} = 0,5F_r + 0,26F_a$$

The single row angular contact ball bearings with contact angle $\alpha = 26^\circ$ (AA)

$$P_{or} = 0,5F_r + 0,37F_a$$

Single Row Angular Contact Ball Bearings

d = 10 - 50 mm

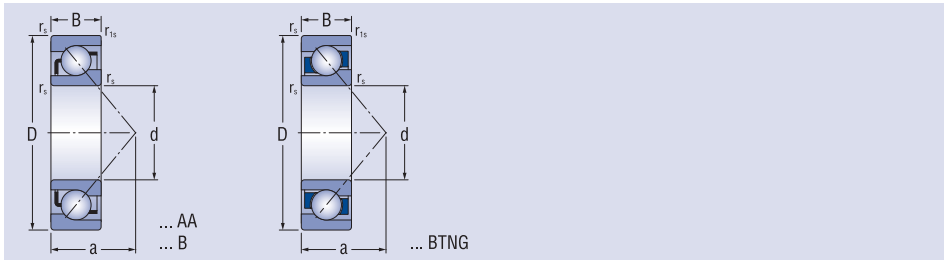

Dimensions						Bearing designation	Basic load rating		Fatigue load limit	Limiting speed for lubrication with		Mass	
d	D	B	r _{smin}	r _{1smin}	a		C _r	C _{0r}		grease	oil		kg
mm							kN			min ⁻¹			
10	30	9	0.6	0.15	9	7200AA	5.6	2.8	0.127		22 000	28 000	0.032
	30	9	0.6	0.3	13	7200B	5.3	2.7	0.123		19 000	27 000	0.030
12	32	10	0.6	0.15	10	7201AA	7.1	3.4	0.154		20 000	25 000	0.037
	32	10	0.6	0.3	14	7201B	6.9	3.2	0.145		18 000	24 000	0.036
	37	12	0.6	0.3	16	7301B	10.5	4.9	0.208		16 000	22 000	0.060
15	35	11	0.6	0.15	11	7202AA	8.4	4.4	0.222		17 000	22 000	0.045
	35	11	0.6	0.3	16	7202B	7.9	4.2	0.191		16 000	22 000	0.045
	42	13	1.0	0.6	16	7302B	12.4	6.5	0.276		14 000	19 000	0.080
17	40	12	0.6	0.3	13	7203AA	10.5	5.7	0.260		15 000	20 000	0.062
	40	12	0.6	0.3	18	7203B	9.9	5.5	0.250		14 000	19 000	0.065
	47	14	1.0	0.3	14.6	7303AA	16.2	8.1	0.368		13 000	19 000	0.065
	47	14	1.0	0.6	20	7303B	14.1	8.1	0.368		13 000	17 000	0.110
20	47	14	1.0	0.3	15	7204AA	14.0	7.8	0.354		13 000	18 000	0.110
	47	14	1.0	0.6	21	7204B	13.4	7.6	0.323		12 000	16 000	0.110
	52	15	1.1	0.6	15.9	7304AA	18.1	10.0	0.454		12 000	17 000	0.150
	52	15	1.1	0.6	23	7304B	17.3	9.6	0.408		11 000	15 000	0.140
25	52	15	1.0	0.3	16	7205AA	15.9	9.9	0.450		11 000	16 000	0.140
	52	15	1.0	0.6	24	7205B	14.8	9.3	0.401		10 000	14 000	0.130
	62	17	1.1	0.6	18.6	7305AA	25.1	14.0	0.636		9 500	14 000	0.230
	62	17	1.1	0.6	27	7305B	24.3	14.1	0.640		9 000	13 000	0.230
30	62	16	1.0	0.3	19	7206AA	22.0	14.0	0.636		9 000	13 000	0.210
	62	16	1.0	0.6	27	7206B	20.5	13.5	0.567		8 500	12 000	0.200
	72	19	1.1	0.6	21.6	7306AA	29.5	17.9	0.813		8 500	12 000	0.350
	72	19	1.1	0.6	31	7306B	29.3	18.1	0.770		8 000	11 000	0.340
35	72	17	1.1	0.6	21	7207AA	29.1	19.1	0.868		8 000	11 000	0.310
	72	17	1.1	0.6	31	7207B	28.3	14.8	0.630		7 500	10 000	0.280
	80	21	1.5	0.6	24.1	7307AA	38.8	24.9	1.132		7 500	10 000	0.470
	80	21	1.5	0.6	35	7307B	38.3	24.4	1.052		7 000	9 500	0.450
40	80	18	1.1	0.6	23	7208AA	35.2	24.4	1.109		7 500	10 000	0.370
	80	18	1.1	0.6	34	7208B	34.5	23.8	1.013		6 700	9 000	0.420
	90	23	1.5	0.6	26.8	7308AA	47.4	31.1	1.413		6 700	9 000	0.660
	90	23	1.5	0.6	39	7308B	46.5	29.5	1.255		6 300	8 500	0.630
45	85	19	1.1	0.6	25	7209AA	36.8	27.2	1.236		6 700	9 000	0.410
	85	19	1.1	0.6	37	7209B	34.0	24.6	1.056		6 300	8 500	0.420
	100	25	1.5	0.6	29.4	7309AA	61.8	41.0	1.864		6 000	8 000	0.860
	100	25	1.5	0.6	43	7309B	59.6	39.6	1.800		5 600	7 500	0.850
50	90	20	1.1	0.6	26	7210AA	40.8	30.5	1.386		6 300	8 500	0.460
	90	20	1.1	0.6	39	7210B	40.4	25.6	1.089		5 600	8 000	0.470
	110	27	2.0	1.0	32.3	7310AA	74.5	54.1	2.459		5 600	7 500	1.080
	110	27	2.0	1.0	47	7310B	68.1	48.0	2.034		5 000	6 700	1.100

Single Row Angular Contact Ball Bearings

d = 55 - 130 mm

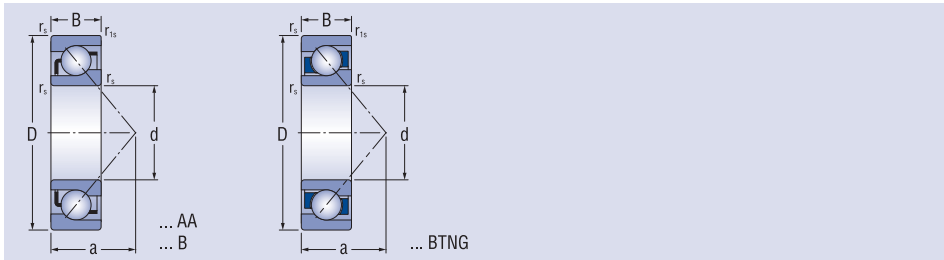

Dimensions						Bearing designation	Basic load rating		Fatigue load limit	Limiting speed for lubrication with		Mass
d	D	B	r _{smin}	r _{1smin}	a		C _r	C _{0r}		grease	oil	
mm							kN			min ⁻¹		
55	100	21	1.5	0.6	29	7211AA	50.5	38.1	1.839	5 600	7 000	0.610
	100	21	1.5	0.6	43	7211B	46.3	36.0	1.500	5 300	7 000	0.620
	120	29	2.0	1.0	35.1	7311AA	88.4	63.5	2.886	5 000	7 300	1.420
	120	29	2.0	1.0	51	7311B	82.2	56.2	2.554	4 500	6 300	1.400
60	110	22	1.5	0.6	31	7212AA	58.2	46.1	2.095	5 300	6 700	0.800
	110	22	1.5	0.6	47	7212B	56.1	44.3	1.885	4 800	6 300	0.800
	130	31	2.1	1.1	37.6	7312AA	101.0	73.6	3.345	4 800	6 300	1.710
	130	31	2.1	1.1	55	7312B	91.5	65.4	2.736	4 300	5 600	1.750
65	120	23	1.5	0.6	33	7213AA	66.6	52.5	2.386	4 800	6 300	1.000
	120	23	1.5	0.6	50.5	7213B	65.7	50.2	2.118	4 300	6 000	1.000
	140	33	2.1	1.1	40.4	7313AA	116.0	84.6	3.845	4 300	5 600	2.230
	140	33	2.1	1.1	60	7313B	102.3	75.3	3.177	3 800	5 300	2.150
70	125	24	1.5	0.6	35	7214AA	69.3	57.4	2.610	4 500	5 800	1.100
	125	24	1.5	0.6	53	7214B	70.4	56.3	2.375	4 000	5 600	1.100
	150	35	2.1	1.1	43.1	7314AA	128.5	96.1	4.271	4 000	5 300	2.670
	150	35	2.1	1.1	64	7314B	114.6	85.9	3.436	3 600	5 000	2.650
75	130	25	1.5	0.6	36	7215AA	75.3	63.0	2.863	4 300	5 600	1.200
	130	25	1.5	0.6	56	7215B	68.6	58.2	2.425	3 800	5 300	1.200
	160	37	2.1	1.1	45.9	7315AA	139.9	108.5	4.717	3 800	5 000	3.100
	160	37	2.1	1.1	68	7315B	127.7	95.4	3.816	3 400	4 800	3.200
80	140	26	2.0	1.0	39	7216AA	85.0	73.5	3.266	4 000	5 300	1.450
	140	26	2.0	1.0	59	7216B	78.7	65.7	2.682	3 800	5 300	1.450
	170	39	2.1	1.1	48.6	7316AA	151.5	121.7	5.291	3 600	4 800	3.600
	170	39	2.1	1.1	72	7316B	141.4	107.9	4.150	3 200	4 800	3.800
85	150	28	2.0	1.0	42	7217AA	94.7	81.4	3.539	3 800	5 000	1.800
	150	28	2.0	1.0	63	7217B	83.2	74.1	2.917	3 600	5 000	1.850
	180	41	3.0	1.1	76	7317B	155.8	120.9	4.478	3 000	4 000	4.450
90	160	30	2.0	1.0	44	7218AA	116.9	100.0	4.255	3 600	4 800	2.250
	160	30	2.0	1.0	67	7218B	107.6	92.4	3.554	3 200	4 300	2.300
	190	43	3.0	1.1	80	7318B	157.9	136.9	4.978	3 000	4 000	5.300
95	170	32	2.1	1.1	47	7219AA	128.2	108.9	4.537	3 400	4 500	2.700
	170	32	2.1	1.1	72	7219B	121.4	106.7	3.981	3 000	4 000	2.700
	200	45	3.0	1.1	84	7319B	172.0	154.1	5.407	2 800	4 000	6.400
100	180	34	2.1	1.1	50	7220AA	141.9	122.0	5.083	3 200	4 300	3.250
	180	34	2.1	1.1	76	7220B	140.7	122.5	4.706	2 800	3 800	3.300
	215	47	3.0	1.1	90	7320B	190.0	177.3	5.930	2 600	3 800	7.290
110	200	38	2.1	1.1	84	7222B	153.8	144.3	5.010	2 400	3 400	4.350
	240	50	3.0	1.1	99	7322B	225.8	225.3	7.268	2 200	3 400	9.840
120	215	40	2.1	1.1	90	7224B	165.4	161.4	5.249	2 200	3 200	5.200
130	230	40	3.0	1.1	96	7226B	170.8	174.2	5.619	1 800	2 800	6.050



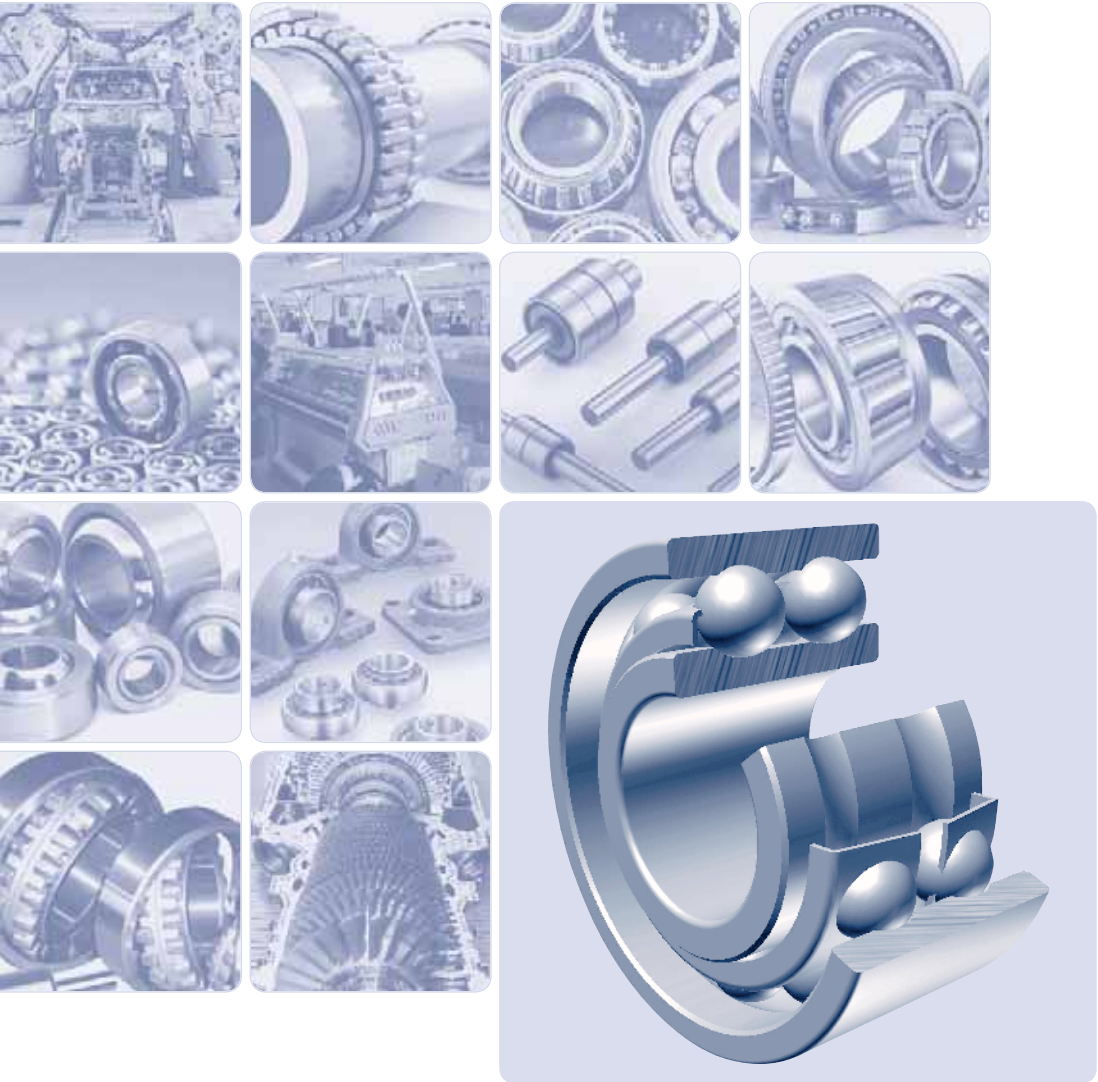

Double Row Angular Contact Ball Bearings

Double Row Angular Contact Ball Bearings

Double Row Angular Contact Ball Bearings

The double-row angular contact ball bearings correspond to their construction and function to a pair of single-row angular contact ball bearings turned by back to back, forming an „O“ shape. Both rings have a relatively deep raceways and they cannot be dismantled. In case of „E“ type construction, there is a filling opening on one side.

The bearings achieve high load rate due to the optimal ball size and their contact with raceways. They can effectively bear radial and axial load in both directions and they are suitable for relatively high rotation frequencies.

The mounting of the "E" type construction bearings should be done in such a way, that the axial force is spread on the row of balls on the side opposite to the filling opening.

The raceways of the double row angular contact ball bearings are constructed in such way, that the flow lines of the contact points between balls and rings intersect the axis of the bearing outside the bearing itself (contact angle $\alpha = 32^\circ$). This way the bearings can transfer the tilting point in the axial plane. Thus if there is limited space for mounting of the turning part, one bearing is sufficient.

Boundary Dimensions

The boundary dimensions of double row angular contact ball bearings indicated in the dimension tables correspond to the international dimensional plan ISO 15.

Designation

The designation of the bearings in the basic design is indicated in the dimension tables. The difference from the basic design is designated by additional symbols according to STN 02 4608.

Bearings with covers

Double row angular contact ball bearings with covers on both sides are produced with cover sheets (2ZR), or seals (2RSR). Bearings with covers on both sides are filled with high-quality plastic lubricant, properties of which assure lubrication throughout the whole lifetime of the bearing at normal operation conditions.

Cages

The double row angular contact ball bearings have a steel pressed cage which is marked. Steel cages are made in two designs depending on the used internal construction. Bearings in basic design have one-piece open cage which is similar to the plastic TNGH cages. Bearings in „E“ design have one cage in S shape which is similar to the one used standard single-row ball bearings.

For special seating requirements, some bearings are produced with polyamide cages which are marked TNGH. Supply of the bearings with this cage must be negotiated in advance.

Tolerance

The double row angular contact ball bearings are commonly manufactured within the normal tolerance class P0 (the symbol P0 is not indicated). For special applications requiring a high accuracy or operating under high speed, bearings within the higher tolerance class P6 can be supplied. The limiting values of the dimensional and running accuracy deviation correspond to ISO 194.

Axial Clearances

The commonly manufactured double row angular contact ball bearings have a normal axial clearance which is not indicated. For special applications, the bearings with the reduced (C2) or increased (C3, C4) axial clearance can be supplied.

Misalignment

For double row angular contact ball bearings mutual misalignment of bearing rings is not permissible. The misalignment of the rings causes additional load on the bearing and can shorten the endurance of the bearing.

Radial Equivalent Dynamic and Static Load

Radial Equivalent Dynamic Load

$$P_r = F_r + 0,73 F_a \quad \text{for } F_a/F_r \leq 0,86$$

$$P_r = 0,62 F_r + 1,17 F_a \quad \text{for } F_a/F_r > 0,86$$

Radial Equivalent Static Load

$$P_{or} = F_r + 0,63 F_a$$

Double Row Angular Contact Ball Bearings

d = 10 - 25 mm

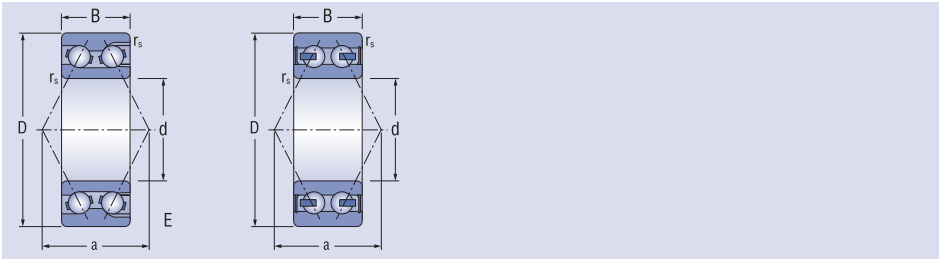

Dimensions					Designation	Basic load ratings		Fatigue load limit	Limiting speeds for lubrication with		Mass	
d	D	B	rs min	a		dynamic	static		grease	oil		
mm						C _r	C _{0r}	C _u			kg	
10	30	14.3	0.6	18.5	3200E	8.4	6.5	0.30		14 000	19 000	0.051
	30	14.3	0.6	17.5	3200	7.6	4.4	0.20		14 000	19 000	0.049
	30	14.3	0.6	17.5	3200-2RSR	7.6	4.4	0.20		12 500		0.049
	30	14.3	0.6	17.5	3200-2ZR	7.6	4.4	0.20		14 000		0.049
12	32	15.9	0.6	20.5	3201E	11.6	7.2	0.32		13 000	17 000	0.060
	32	15.9	0.6	19.0	3201	9.1	5.1	0.23		13 000	17 000	0.057
	32	15.9	0.6	19.0	3201-2RSR	9.1	5.1	0.23		11 500		0.057
	32	15.9	0.6	19.0	3201-2ZR	9.1	5.1	0.23		13 000		0.057
15	35	15.9	0.6	22.5	3202E	13.2	9.1	0.41		11 000	15 000	0.069
	35	15.9	0.6	21.0	3202	10.0	6.1	0.28		11 000	15 000	0.064
	35	15.9	0.6	21.0	3202-2RSR	10.0	6.1	0.28		9 600		0.064
	35	15.9	0.6	21.0	3202-2ZR	10.0	6.1	0.28		11 000		0.064
	42	19.0	1.0	26.0	3302E	16.7	11.9	0.51		9 900	13 000	0.127
	42	19.0	1.0	26.0	3302	12.3	8.0	0.36		9 900	13 000	0.132
	42	19.0	1.0	26.0	3302-2RSR	12.3	8.0	0.36		8 500		0.132
17	42	19.0	1.0	26.0	3302-2ZR	12.3	8.0	0.36		9 900		0.132
	40	17.5	0.6	25.5	3203E	14.5	11.0	0.53		9 900	13 000	0.099
	40	17.5	0.6	24.0	3203	12.3	8.0	0.36		9 900	13 000	0.096
	40	17.5	0.6	24.0	3203-2RSR	12.3	8.0	0.36		8 500		0.096
	40	17.5	0.6	24.0	3203-2ZR	12.3	8.0	0.36		9 900		0.096
	47	17.5	0.6	28.5	3303E	20.7	15.1	0.68		9 000	12 000	0.185
	47	22.2	1.0	28.5	3303	17.4	10.4	0.47		9 000	12 000	0.181
	47	22.2	1.0	28.5	3303-2RSR	17.4	10.4	0.47		7 700		0.181
20	47	22.2	1.0	28.5	3303-2ZR	17.4	10.4	0.47		9 000		0.181
	47	20.6	1.0	29.5	3204E	20.7	15.2	0.69		8 800	12 000	0.166
	47	20.6	1.0	28.0	3204	19.0	12.1	0.55		8 800	12 000	0.153
	47	20.6	1.0	28.0	3204-2RSR	19.0	12.1	0.55		8 800		0.153
	47	20.6	1.0	28.0	3204-2ZR	19.0	12.1	0.55		7 400		0.153
	52	20.6	1.1	32.0	3304E	25.0	18.6	0.84		8 000	11 000	0.221
	52	22.2	1.1	30.5	3304	22.6	14.5	0.66		8 000	11 000	0.227
	52	22.2	1.1	30.5	3304-2RSR	22.6	14.5	0.66		6 700		0.227
25	52	22.2	1.1	30.5	3304-2ZR	22.6	14.5	0.66		8 000		0.227
	52	20.6	1.0	32.5	3205E	22.8	18.4	0.83		7 300	9 800	0.183
	52	20.6	1.0	31.5	3205	20.6	14.1	0.64		7 300	9 800	0.175
	52	20.6	1.0	31.5	3205-2RSR	20.6	14.1	0.64		6 000		0.175
	52	20.6	1.0	31.5	3205-2ZR	20.6	14.1	0.64		7 300		0.175
	62	25.4	1.1	38.0	3305E	34.7	26.8	1.22		6 700	8 900	0.354
	62	25.4	1.1	36.5	3305	26.7	18.0	0.82		6 700	8 900	0.362
	62	25.4	1.1	36.5	3305-2RSR	26.7	18.0	0.82		5 500		0.362
	62	25.4	1.1	36.5	3305-2ZR	26.7	18.0	0.82		6 700		0.362

Double Row Angular Contact Ball Bearings

d = 30 - 50 mm

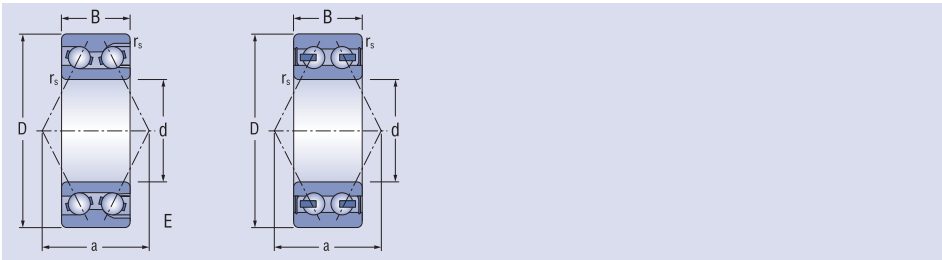

Dimensions					Designation	Basic load ratings		Fatigue load limit	Limiting speeds for lubrication with		Mass
d	D	B	r _s min	a		dynamic	static		grease	oil	
mm	mm	mm	mm	mm		C _r	C _{0r}	C _u	min ⁻¹	min ⁻¹	kg
30	62	23.8	1.0	38.5	3206E	32.7	27.4	1.24	6 300	8 400	0.303
	62	23.8	1.0	36.5	3206	24.4	17.6	0.80	6 300	8 400	0.286
	62	23.8	1.0	36.5	3206-2RSR	24.4	17.6	0.80	5 000		0.286
	62	23.8	1.0	36.5	3206-2ZR	24.4	17.6	0.80	6 300		0.286
	72	30.2	1.1	44.5	3306E	45.8	37.0	1.70	5 700	7 600	0.558
	72	30.2	1.1	43.0	3306	37.2	25.9	1.18	5 700	7 600	0.553
	72	30.2	1.1	43.0	3306-2RSR	37.2	25.9	1.18	4 500		0.553
35	72	27.0	1.1	44.5	3207E	38.1	33.2	1.52	5 500	7 400	0.458
	72	27.0	1.1	42.5	3207	33.0	24.4	1.11	5 500	7 400	0.436
	72	27.0	1.1	42.5	3207-2RSR	33.0	24.4	1.11	4 200		0.436
	72	27.0	1.1	42.5	3207-2ZR	33.0	24.4	1.11	5 500		0.436
	80	34.9	1.5	50.0	3307E	58.3	47.5	2.15	5 000	6 600	0.756
	80	34.9	1.5	48.5	3307	49.5	35.1	1.59	5 000	6 600	0.756
	80	34.9	1.5	48.5	3307-2RSR	49.5	35.1	1.59	3 800		0.756
40	80	30.2	1.1	49.0	3208E	50.4	44.6	2.03	4 900	6 600	0.627
	80	30.2	1.1	47.5	3208	40.1	30.6	1.40	4 900	6 600	0.590
	80	30.2	1.1	47.5	3208-2RSR	40.1	30.6	1.40	3 800		0.590
	80	30.2	1.1	47.5	3208-2ZR	40.1	30.6	1.40	4 900		0.590
	90	36.5	1.5	55.0	3308E	72.0	60.3	2.68	4 400	5 900	1.030
	90	36.5	1.5	53.5	3308	60.5	44.0	2.00	4 400	5 900	1.010
	90	36.5	1.5	53.5	3308-2RSR	60.5	44.0	2.00	3 300		1.010
	90	36.5	1.5	53.5	3308-2ZR	60.5	44.0	2.00	4 400		1.010
	45	85	30.2	1.1	52.5	3209E	54.8	52.0	2.36	4 400	5 900
85		30.2	1.1	50.5	3209	42.8	34.6	1.57	4 400	5 900	0.640
85		30.2	1.1	50.5	3209-2RSR	42.8	34.6	1.57	3 300		0.640
85		30.2	1.1	50.5	3209-2ZR	42.8	34.6	1.57	4 400		0.640
100		39.7	1.5	61.0	3309E	87.1	74.4	3.35	4 000	5 300	1.370
100		39.7	1.5	60.0	3309	72.5	54.0	2.45	4 000	5 300	1.340
100		39.7	1.5	60.0	3309-2RSR	72.5	54.0	2.45	2 900		1.340
100		39.7	1.5	60.0	3309-2ZR	72.5	54.0	2.45	4 000		1.340
50	90	30.2	1.1	55.5	3210E	54.2	53.0	2.41	4 000	5 300	0.698
	90	30.2	1.1	54.0	3210	45.2	38.9	1.77	4 000	5 300	0.689
	90	30.2	1.1	54.0	3210-2RSR	45.2	38.9	1.77	2 900		0.689
	90	30.2	1.1	54.0	3210-2ZR	45.2	38.9	1.77	4 000		0.689
	110	44.4	2.0	67.0	3310E	103.3	90.0	4.07	3 600	4 800	1.980
	110	44.4	2.0	65.5	3310	85.3	64.7	2.94	3 600	4 800	1.810
	110	44.4	2.0	65.5	3310-2RSR	85.3	64.7	2.94	2 500		1.810
	110	44.4	2.0	65.5	3310-2ZR	85.3	64.7	2.94	3 600		1.810

Double Row Angular Contact Ball Bearings

d = 55 - 75 mm

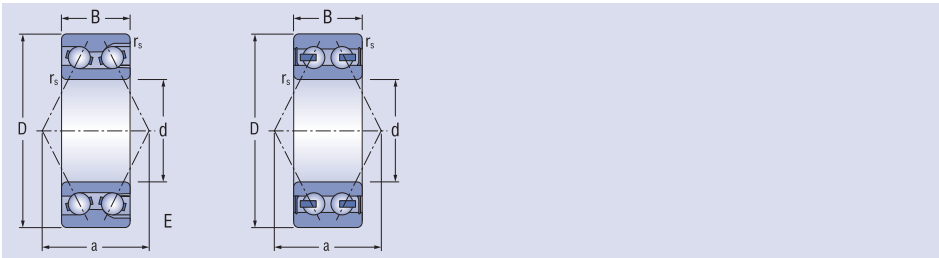

Dimensions					Designation	Basic load ratings		Fatigue load limit	Limiting speeds for lubrication with		Mass
d	D	B	r _s min	a		dynamic	static		grease	oil	
mm						C _r	C _{0r}	C _u			kg
55	100	33.3	1.5	61.5	3211E	69.3	68.8	3.11	3 600	4 900	1.070
	100	33.3	1.5	60.5	3211	54.0	47.3	2.15	3 600	4 900	0.986
	100	33.3	1.5	60.5	3211-2RSR	54.0	47.3	2.15	2 500		0.986
	100	33.3	1.5	60.5	3211-2ZR	54.0	47.3	2.15	3 600		0.986
	120	49.2	2.0	75.0	3311E	114.2	108.0	4.91	3 300	4 400	2.420
	120	49.2	2.0	73.0	3311	106.3	82.0	3.71	3 300	4 400	2.320
	120	49.2	2.0	73.0	3311-2RSR	106.3	82.0	3.71	2 300		2.320
60	120	49.2	2.0	73.0	3311-2ZR	106.3	82.0	3.71	3 300		2.320
	110	36.5	1.5	67.5	3212E	85.9	86.6	3.95	3 400	4 500	1.340
	110	36.5	1.5	65.5	3212	59.9	53.8	2.44	3 400	4 500	1.270
	110	36.5	1.5	65.5	3212-2RSR	59.9	53.8	2.44	2 400		1.270
	110	36.5	1.5	65.5	3212-2ZR	59.9	53.8	2.44	3 400		1.270
	130	54.0	1.5	82.0	3312E	123.5	119.6	5.42	3 000	4 000	3.070
	130	54.0	2.1	79.5	3312	121.5	95.5	4.32	3 000	4 000	3.050
65	130	54.0	2.1	79.5	3312-2RSR	121.5	95.5	4.32	2 100		3.050
	130	54.0	2.1	79.5	3312-2ZR	121.5	95.5	4.32	3 000		3.050
	120	38.1	1.5	72.5	3213E	85.0	87.7	4.00	3 100	4 200	1.680
	120	38.1	1.5	71.0	3213	73.5	66.7	3.00	3 100	4 200	1.570
	120	38.1	1.5	71.0	3213-2RSR	73.5	66.7	3.00	2 100		1.570
	120	38.1	1.5	71.0	3213-2ZR	73.5	66.7	3.00	3 100		1.570
	140	58.7	2.1	88.5	3313E	154.3	150.8	6.82	2 800	3 700	3.900
70	140	58.7	2.1	84.5	3313	138.0	109.0	4.95	2 800	3 700	3.960
	140	58.7	2.1	84.5	3313-2RSR	138.0	109.0	4.95	1 900		3.960
	140	58.7	2.1	84.5	3313-2ZR	138.0	109.0	4.95	2 800		3.960
	125	39.7	1.5	76.5	3214E	91.2	99.9	4.50	2 900	3 900	1.840
	125	39.7	1.5	74.5	3214	80.6	73.9	3.36	2 900	3 900	1.800
75	125	39.7	1.5	74.5	3214-2RSR	80.6	73.9	3.36	2 000		1.800
	125	39.7	1.5	74.5	3214-2ZR	80.6	73.9	3.36	2 900		1.800
	150	63.5	2.1	97.0	3314E	153.8	153.9	6.70	2 600	3 500	5.200
	150	63.5	2.1	93.0	3314	155.0	125.2	5.44	2 600	3 500	4.740
	150	63.5	2.1	93.0	3314-2RSR	155.0	125.2	5.44	1 800		4.740
	150	63.5	2.1	93.0	3314-2ZR	155.0	125.2	5.44	2 600		4.740
	130	41.3	1.5	79.5	3215E	100.5	111.3	5.00	2 700	3 600	2.010
75	130	41.3	1.5	78.0	3215	88.0	81.5	3.51	2 700	3 600	1.900
	130	41.3	1.5	78.0	3215-2RSR	88.0	81.5	3.51	1 900		1.900
	130	41.3	1.5	78.0	3215-2ZR	88.0	81.5	3.51	2 700		1.900
	160	68.3	2.1	104.0	3315E	199.7	199.4	8.40	2 400	3 200	6.300
	160	68.3	2.1	98.0	3315	168.3	141.3	5.64	2 400	3 200	5.650
	160	68.3	2.1	98.0	3315-2RSR	168.3	141.3	5.64	1 700		5.650
	160	68.3	2.1	98.0	3315-2ZR	168.3	141.3	5.64	2 400		5.650

Double Row Angular Contact Ball Bearings

d = 80 - 100 mm

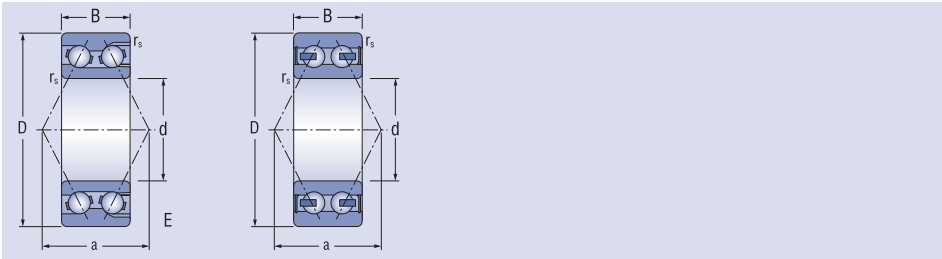

Dimensions					Designation	Basic load ratings		Fatigue load limit	Limiting speeds for lubrication with		Mass
d	D	B	r _s min	a		dynamic	static		grease	oil	
mm						C _r	C _{0r}	C _u			kg
80	140	44.4	2.0	88.0	3216E	120.9	135.1	5.90	2 500	3 400	2.710
	140	44.4	2.0	83.5	3216	104.0	97.2	4.20	2 500	3 400	2.390
	140	44.4	2.0	83.5	3216-2RSR	104.0	97.2	4.20	1 800		2.390
	140	44.4	2.0	83.5	3216-ZZR	104.0	97.2	4.20	2 500		2.390
	170	68.3	2.0	113.1	3316E	224.3	226.8	9.20	2 400	3 200	7.210
	170	68.3	2.1	102.5	3316	182.3	160.7	6.53	2 400	3 200	7.210
	170	68.3	2.1	102.5	3316-2RSR	182.3	160.7	6.53	1 700		7.210
85	170	68.3	2.1	102.5	3316-ZZR	182.3	160.7	6.53	2 400		7.210
	150	49.2	2.0	95.0	3217E	121.3	131.8	5.72	2 400	3 200	3.480
	150	49.2	2.0	91.0	3217	112.0	106.5	4.50	2 400	3 200	3.060
	150	49.2	2.0	91.0	3217-2RSR	112.0	106.5	4.50	1 700		3.060
	150	49.2	2.0	91.0	3217-ZZR	112.0	106.5	4.50	2 400		3.060
	180	73.0	3.0	118.0	3317E	244.2	256.1	10.1	2 200	3 000	8.300
	180	73.0	3.0	110.0	3317	196.0	185.0	7.30	2 200	3 000	8.300
90	180	73.0	3.0	110.0	3317-2RSR	196.0	185.0	7.30	1 600		8.300
	180	73.0	3.0	110.0	3317-ZZR	196.0	185.0	7.30	2 200		8.300
	160	52.4	2.0	101.0	3218E	166.2	180.6	7.30	2 200	3 000	4.240
	160	52.4	2.0	95.5	3218	119.8	116.3	4.73	2 200		3.730
	160	52.4	2.0	95.5	3218-2RSR	119.8	116.3	4.73	1 600		3.730
	160	52.4	2.0	95.5	3218-ZZR	119.8	116.3	4.73	2 200		3.730
	190	73.0	3.0	125.5	3318E	257.9	268.5	10.3	2 100	2 800	9.230
95	190	73.0	3.0	136.0	3318	211.4	196.9	7.61	2 100	2 800	9.230
	190	73.0	3.0	136.0	3318-2RSR	211.4	196.9	7.61	1 500		9.230
	190	73.0	3.0	136.0	3318-ZZR	211.4	196.9	7.61	2 100		9.230
	170	55.6	2.1	106.0	3219E	178.4	205.8	8.10	2 100	2 800	5.100
	170	55.6	2.1	106.0	3219	138.9	130.9	5.17	2 100		5.100
	170	55.6	2.1	106.0	3219-2RSR	138.9	130.9	5.17	1 500		5.100
	170	55.6	2.1	106.0	3219-ZZR	138.9	130.9	5.17	2 100		5.100
100	200	77.8	3.0	132.2	3319E	285.4	319.9	11.9	2 000	2 600	10.90
	200	77.8	3.0	143.0	3319	233.0	226.0	8.45	2 000	2 600	11.40
	200	77.8	3.0	143.0	3319-2RSR	233.0	226.0	8.45	1 400		11.40
	200	77.8	3.0	143.0	3319-ZZR	233.0	226.0	8.45	2 000		11.40
	180	60.3	2.1	111.0	3220E	177.0	207.1	8.0	2 000	2 700	5.880
	180	60.3	2.1	111.0	3220	157.6	150.3	5.75	2 000	2 700	5.880
	180	60.3	2.1	111.0	3220-2RSR	157.6	150.3	5.75	1 400		5.880
100	180	60.3	2.1	111.0	3220-ZZR	157.6	150.3	5.75	2 000		5.880
	215	82.6	3.0	140.4	3320E	296.5	330.5	12.0	1 800	2 500	13.50
	215	82.6	3.0	153.0	3320	296.5	332.6	12.0	1 800	2 500	14.60
	215	82.6	3.0	153.0	3320-2RSR	296.5	332.6	12.0	1 300		14.60
	215	82.6	3.0	153.0	3320-ZZR	296.5	332.6	12.0	1 800	2 500	14.60



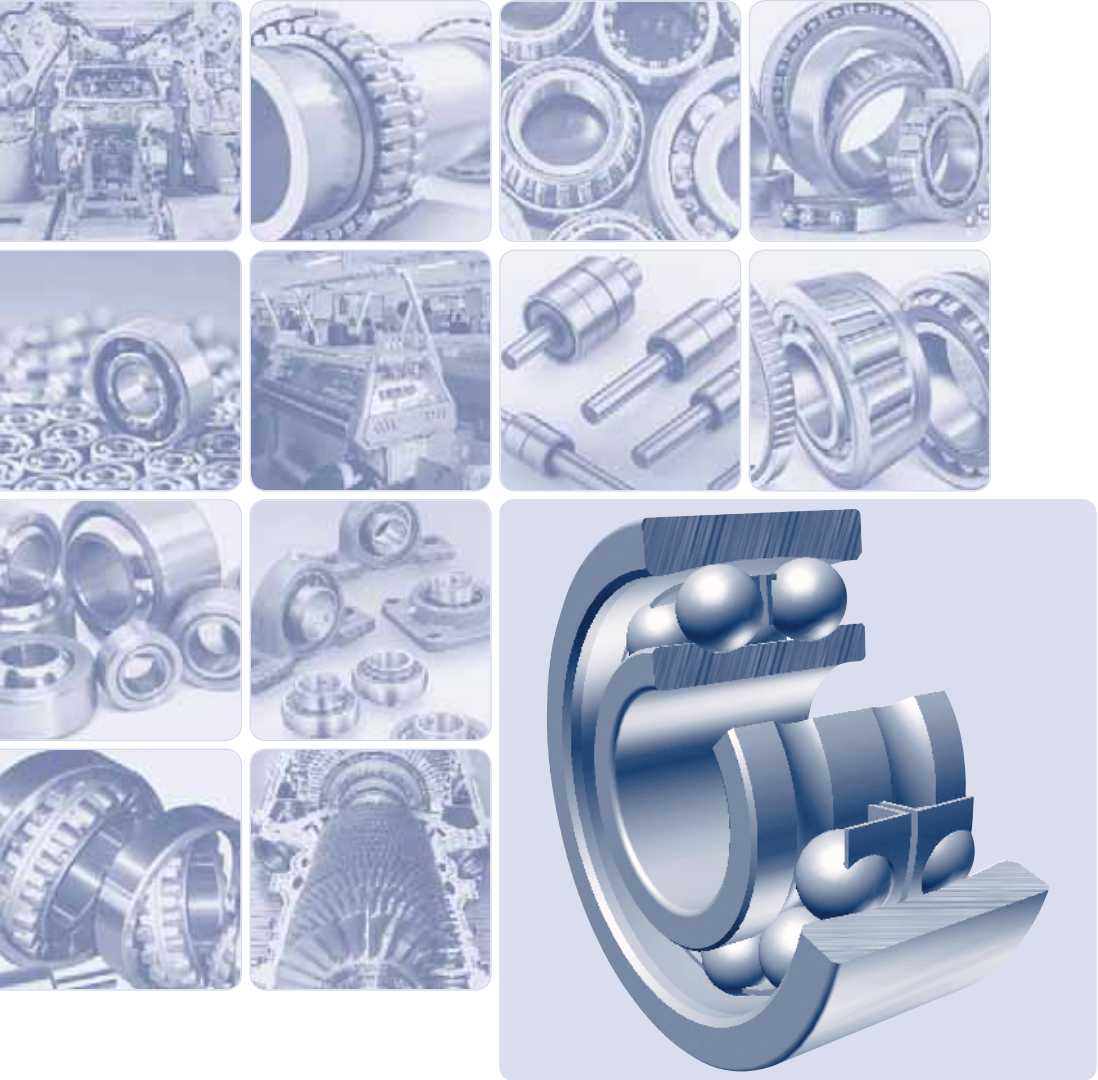

Double Row Self-Aligning Ball Bearings

Double Row Self-Aligning Ball Bearings

Double Row Self-Aligning Ball Bearings

The double row self-aligning ball bearings have two rows of balls and a spherical raceway on the outer ring. Certain misalignment of the inner ring referring to the outer ring around the bearing centre will work independently of the bearing operation. The bearings are used for applications which presume certain bore misalignment in the bearing housings or deflection and oscillation of the shaft at long mutual distance of the bearing. The bearings are non-separable. With respect to their small contact angle and the imperfect conformity of the balls to the raceways, they are not recommended for carrying larger axial forces. The bearings are manufactured with cylindrical or tapered bores.

Boundary Dimensions

The boundary dimensions of the double row self-aligning ball bearings indicated in the dimension tables correspond to the international dimensional plan ISO 15. Adapter sleeve dimension correspond to dimension according to ISO 113.

Designation

The designation of the bearings in the basic design and in the modification with a tapered bore (K) is indicated in the dimension tables. Bearing differences from the basic design are indicated by additional symbols.

Tapered Bore

The double row self-aligning ball bearings are manufactured with a cylindrical or tapered bore (K), taper 1:12 as indicated in the dimension tables. The bearings are fixed on cylindrical shafts by adapter sleeves. The designation of the adapter sleeves belonging to individual bearings is stated in the table section of this publication.

Cages

The double row self-aligning ball bearings have cages made by pressing a steel sheet which are not designated. Bearings of the 12, 13 Series have a single cage. Bearings of the 22, 23 Series have a two-piece cage. For special applications, bearings with polyamide cages which are marked TNGH can be manufactured. The delivery of the bearings with this cage must be negotiated in advance.

Tolerance

The double row self-aligning ball bearings are commonly manufactured within the normal tolerance class P0 (the symbol P0 is not indicated). For special applications requiring high accuracy or in operation under high speed, the bearings can be supplied in the higher tolerance class P6.

Radial Clearance

The commonly manufactured double row self-aligning ball bearings have a normal radial clearance which is not indicated. For special applications, bearings with reduced (C2) or increased (C3, C4) radial clearances can be supplied.

Misalignment

The double row self-aligning ball bearings can be tilted out of the central position without affecting the correct bearing operation. The permissible misalignment values are stated in the following chart.

Bearing Type	Permissible Misalignment
13, 23	3°
12, 22	2°30'

Radial Equivalent Dynamic Load

$$P_r = F_r + Y_1 F_a \quad \text{for } F_a/F_r \leq e$$

$$P_r = 0,65 F_r + Y_2 F_a \quad \text{for } F_a/F_r > e$$

The factor values e , Y_1 and Y_2 for individual bearings, are indicated in the dimension tables.

Radial Equivalent Static Load

$$P_{0r} = F_r + Y_0 F_a$$

The factor values Y_0 for individual bearings are indicated in the dimension tables.

Double Row Self-Aligning Ball Bearings

d = 10 - 45 mm

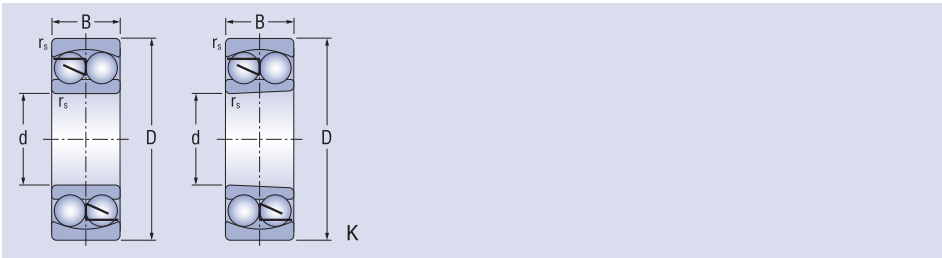

Dimensions				Designation Cylindrical Bore	Tapered Bore	Basic load ratings		Fatigue load limit	Limiting speeds for lubrication with		Mass	K	Corresponding adapter sleeve	Coefficients			
d	D	B	r _{smin}			C _r	C _{0r}		C _u	grease				oil	e	Y ₁	Y ₂
mm							kN		min ⁻¹	kg							
10	30	9	0.6	1200	—	3.7	1.6	0.07	20 000	21 000	0.035	—	—	0.32	2.0	3.0	2.0
	30	14	0.6	2200	—	7.1	1.6	0.07	24 000	28 000	0.050	—	—	0.65	1.0	1.5	1.0
	35	11	0.6	1300	—	7.2	1.6	0.07	20 000	24 000	0.060	—	—	0.33	1.9	3.0	2.0
12	32	10	0.6	1201	—	6.8	2.0	0.09	19 000	21 000	0.042	—	—	0.34	1.9	2.9	2.0
	32	14	0.6	2201	—	8.1	1.7	0.08	22 000	26 000	0.059	—	—	0.57	1.1	1.7	1.2
	37	12	1.0	1301	—	9.4	2.1	0.10	18 000	22 000	0.070	—	—	0.35	1.8	2.8	1.9
	37	17	1.0	2301	—	12.5	2.7	0.12	17 000	22 000	0.104	—	—	0.6	1.05	1.6	1.1
15	35	11	0.6	1202	—	6.8	2.0	0.09	16 000	20 000	0.051	—	—	0.33	1.9	2.9	2.0
	35	14	0.6	2202	—	8.5	1.8	0.08	16 000	18 000	0.060	—	—	0.49	1.3	2.0	1.3
	42	13	1.0	1302	—	9.5	2.3	0.10	16 000	20 000	0.100	—	—	0.33	1.9	2.9	2.0
	42	17	1.0	2302	—	12.0	2.9	0.13	14 000	18 000	0.143	—	—	0.52	1.2	1.9	1.3
17	40	12	0.6	1203	1203K	7.9	2.0	0.09	16 000	20 000	0.076	0.074	H203	0.31	2.1	3.2	2.2
	40	16	0.6	2203	—	10.5	2.4	0.11	14 000	16 000	0.090	—	—	0.50	1.3	1.9	1.3
	47	14	1.0	1303	—	12.5	3.2	0.14	14 000	17 000	0.140	—	—	0.33	1.9	3.0	2.0
	47	19	1.0	2303	—	14.5	3.6	0.16	13 000	16 000	0.176	—	—	0.52	1.2	1.9	1.3
20	47	14	1.0	1204	1204K	10.0	2.9	0.13	14 000	17 000	0.120	0.118	H204	0.27	2.3	3.6	2.4
	47	18	1.0	2204	—	11.5	2.8	0.13	13 000	14 000	0.150	—	—	0.49	1.3	2.0	1.4
	52	15	1.1	1304	—	12.5	3.4	0.15	12 000	15 000	0.170	—	—	0.29	2.2	3.3	2.3
	52	21	1.1	2304	—	20.5	5.5	0.25	12 000	12 000	0.220	—	—	0.51	1.2	1.9	1.3
25	52	15	1.0	1205	1205K	12.0	3.3	0.15	12 000	14 000	0.140	0.138	H205	0.27	2.3	3.6	2.4
	52	18	1.0	2205	2205K	12.5	3.4	0.16	12 000	14 000	0.163	0.158	H305	0.43	1.5	2.3	1.5
	62	17	1.1	1305	1305K	17.8	5.1	0.23	10 000	13 000	0.257	0.252	H305	0.28	2.3	3.5	2.4
	62	24	1.1	2305	2305K	26.5	6.5	0.30	10 000	11 000	0.355	0.327	H2305	0.47	1.3	2.1	1.4
30	62	16	1.0	1206	1206K	15.8	4.7	0.21	10 000	12 000	0.230	0.226	H206	0.25	2.6	4.0	2.7
	62	20	1.0	2206	2206K	15.2	4.6	0.21	10 000	12 000	0.260	0.254	H306	0.40	1.6	2.5	1.7
	72	19	1.1	1306	1306K	21.5	6.3	0.29	8 500	11 000	0.398	0.392	H306	0.26	2.5	3.8	2.6
	72	27	1.1	2306	2306K	31.5	8.7	0.40	8 000	10 000	0.520	0.509	H2306	0.44	1.4	2.2	1.5
35	72	17	1.1	1207	1207K	15.8	5.1	0.23	8 500	10 000	0.320	0.315	H207	0.23	2.7	4.2	2.9
	72	23	1.1	2207	2207K	21.8	6.7	0.30	8 500	10 000	0.440	0.433	H307	0.37	1.7	2.6	1.8
	80	21	1.5	1307	1307K	25.0	8.0	0.36	7 500	9 500	0.540	0.532	H307	0.25	2.6	4.0	2.7
	80	31	1.5	2307	2307K	39.2	11.0	0.50	7 100	9 000	0.680	0.670	H2307	0.46	1.4	2.1	1.4
40	80	18	1.1	1208	1208K	19.2	6.4	0.29	7 500	9 000	0.418	0.412	H208	0.22	2.9	4.4	3.0
	80	23	1.1	2208	2208K	22.5	7.4	0.34	7 500	9 000	0.510	0.502	H308	0.33	1.9	2.9	2.0
	90	23	1.5	1308	1308K	29.5	9.5	0.43	6 700	8 500	0.720	0.620	H308	0.24	2.6	4.1	2.7
	90	33	1.5	2308	2308K	44.8	13.2	0.60	6 300	8 000	0.962	0.950	H2308	0.43	1.5	2.3	1.5
45	85	19	1.1	1209	1209K	21.8	7.3	0.33	7 100	8 500	0.468	0.462	H209	0.21	3.0	4.6	3.1
	85	23	1.1	2209	2209K	23.2	8.0	0.36	7 100	8 500	0.547	0.537	H309	0.31	2.1	3.2	2.2
	100	25	1.5	1309	1309K	38.0	12.8	0.58	6 300	7 500	0.958	0.944	H309	0.25	2.5	3.9	2.7
	100	36	1.5	2309	2309K	55.0	16.2	0.74	5 600	7 100	1.277	1.263	H2309	0.42	1.5	2.3	1.6

Double Row Self-Aligning Ball Bearings

d = 50 - 95 mm

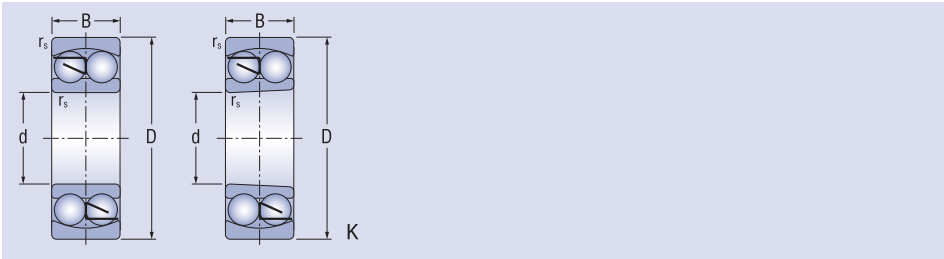

Dimensions				Designation		Basic load ratings		Fatigue load limit	Limiting speeds		Mass		Corresponding	Coefficients			
d	D	B	r _{smin}	Cylindrical Bore	Tapered Bore	dynamic	static	C _u	for lubrication with grease	oil	~	K	adapter sleeve	e	Y ₁	Y ₂	Y ₀
mm						C _r	C _{0r}		min ⁻¹		kg						
50	90	20	1.1	1210	1210K	22.8	8.1	0.37	6 300	8 000	0.526	0.517	H210	0.20	3.1	4.9	3.3
	90	23	1.1	2210	2210K	23.2	8.5	0.38	6 300	8 000	0.599	0.585	H310	0.29	2.2	3.4	2.3
	110	27	2.0	1310	1310K	43.2	14.2	0.65	5 600	6 700	1.208	1.191	H310	0.24	2.7	4.1	2.8
	110	40	2.0	2310	2310K	64.5	19.8	0.90	5 000	6 300	1.689	1.671	H2310	0.43	1.5	2.3	1.6
55	100	21	1.5	1211	1211K	26.8	10.0	0.45	6 000	7 100	0.718	0.706	H211	0.20	3.2	5.0	3.4
	100	25	1.5	2211	2211K	26.8	10.0	0.45	6 000	7 100	0.810	0.792	H311	0.28	2.3	3.5	2.4
	120	29	2.0	1311	1311K	51.6	18.2	0.83	5 000	6 300	1.580	1.560	H311	0.24	2.7	4.2	2.8
	120	43	2.0	2311	2311K	75.2	23.5	1.07	4 800	6 000	2.094	2.070	H2311	0.41	1.5	2.4	1.6
60	110	22	1.5	1212	1212K	30.2	11.5	0.52	5 300	6 300	0.900	0.887	H212	0.19	3.4	5.3	3.6
	110	28	1.5	2212	2212K	34.0	12.5	0.57	5 300	6 300	1.096	1.076	H312	0.28	2.3	3.5	2.4
	130	31	2.0	1312	1312K	57.2	20.8	0.94	4 500	5 600	1.960	1.930	H312	0.23	2.8	4.3	2.9
	130	46	2.0	2312	2312K	86.8	27.5	1.25	4 300	5 300	2.610	2.540	H2312	0.41	1.6	2.4	1.6
65	120	23	1.5	1213	1213K	31.0	12.5	0.57	4 800	6 000	1.080	0.901	H213	0.17	3.7	5.7	3.9
	120	31	1.5	2213	2213K	43.5	16.2	0.74	4 800	6 000	1.467	1.436	H313	0.28	2.2	3.5	2.3
	140	33	2.1	1313	1313K	61.8	22.8	1.01	4 300	5 300	2.370	2.330	H313	0.23	2.8	4.3	2.9
	140	48	2.1	2313	2313K	96.0	32.5	1.48	3 800	4 800	3.220	3.150	H2313	0.38	1.6	2.5	1.7
70	125	24	1.5	1214	1214K	34.5	13.5	0.61	4 600	5 600	1.290	1.265	H214	0.18	3.5	5.4	3.7
	125	31	1.5	2214	2214K	44.0	17.0	0.77	4 500	5 600	1.620	1.585	H314	0.27	2.4	3.7	2.5
	150	35	2.1	1314	1314K	74.5	27.5	1.19	4 000	5 000	2.980	2.935	H314	0.22	2.8	4.4	3.0
	150	51	2.1	2314	2314K	110.0	37.5	1.62	3 600	4 500	3.920	3.830	H2314	0.38	1.7	2.6	1.8
75	130	25	1.5	1215	1215K	38.8	15.2	0.69	4 300	5 300	1.350	1.330	H215	0.18	3.6	5.6	3.8
	130	31	1.5	2215	2215K	44.2	18.0	0.82	4 300	5 300	1.720	1.680	H315	0.25	2.5	3.9	2.6
	160	37	2.1	1315	1315K	79.0	29.8	1.24	3 800	4 500	3.550	3.500	H315	0.22	2.8	4.4	3.1
	160	55	2.1	2315	2315K	122.0	42.8	1.80	3 400	4 300	4.710	4.600	H2315	0.38	1.7	2.6	1.8
80	140	26	2.0	1216	1216K	39.5	16.8	0.72	4 000	5 000	1.650	1.620	H216	0.16	3.9	6.1	3.8
	140	33	2.0	2216	2216K	48.8	20.2	0.88	4 000	5 000	2.190	2.120	H316	0.25	2.5	3.9	2.6
	170	39	2.1	1316	1316K	88.5	32.8	1.32	3 600	4 300	4.190	4.130	H316	0.22	2.9	4.5	3.1
	170	58	2.1	2316	2316K	128.0	45.5	1.85	3 200	4 000	5.700	5.560	H2316	0.37	1.7	2.6	1.8
85	150	28	2.0	1217	1217K	48.8	20.5	0.86	3 800	4 500	2.100	2.065	H217	0.17	3.7	5.7	3.9
	150	36	2.0	2217	2217K	58.2	23.5	0.99	3 800	4 500	2.530	2.470	H317	0.25	2.5	3.8	2.6
	180	41	3.0	1317	1317K	97.8	37.8	1.48	3 400	4 000	4.950	4.870	H317	0.22	2.9	4.5	3.0
	180	60	3.0	2317	2317K	134.0	48.8	1.95	3 000	3 800	6.730	6.570	H2317	0.37	1.7	2.7	1.8
90	160	30	2.0	1218	1218K	56.5	23.2	0.94	3 600	4 300	2.440	2.400	H218	0.17	3.8	5.8	3.9
	160	40	2.0	2218	2218K	70.0	28.5	1.16	3 600	4 300	3.220	3.150	H318	0.27	2.4	3.6	2.5
	190	43	3.0	1318	1318K	115.0	44.5	1.71	3 200	3 800	5.990	5.900	H318	0.22	2.8	4.4	3.0
	190	64	3.0	2318	2318K	142.0	57.2	2.22	2 800	3 600	8.270	8.080	H2318	0.38	1.7	2.6	1.8
95	170	32	2.1	1219	1219K	63.5	27.0	1.06	3 400	4 000	3.060	3.000	H219	0.17	3.7	5.7	3.9
	170	43	2.1	2219	2219K	82.8	33.8	1.33	3 400	4 000	4.200	4.100	H319	0.27	2.4	3.6	2.5
	200	45	3.0	1319	1319K	125.0	46.0	1.72	3 000	3 600	6.980	6.880	H319	0.23	2.8	4.3	2.9
	200	67	3.0	2319	2319K	162.0	68.8	2.62	2 600	3 400	9.560	9.340	H2319	0.38	1.7	2.6	1.8

Double Row Self-Aligning Ball Bearings

d = 85 - 100 mm

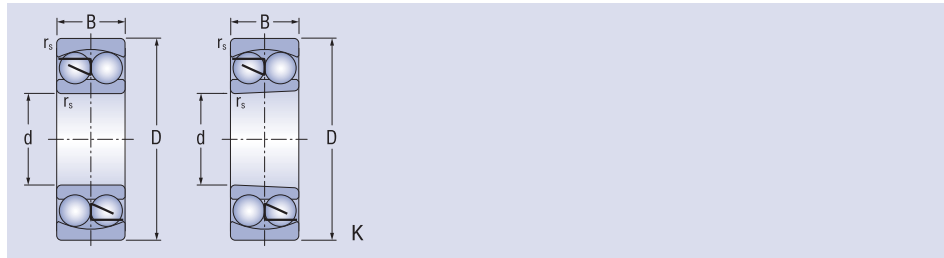

Dimensions				Designation		Basic load ratings		Fatigue load limit	Limiting speeds for lubrication with grease	Limiting speeds for lubrication with oil	Mass	K	Corresponding adapter sleeve	Coefficients			
d	D	B	r _{smin}	Cylindrical Bore	Tapered Bore	dynamic	static	C _u						~	e	Y ₁	Y ₂
mm						C _r	C _{0r}		min ⁻¹	kg							
100	180	34	2.1	1220	1220K	68.5	29.2	1.12	3 200	3 800	3.700	3.640	H220	0.17	3.6	5.6	3.8
	180	46	2.1	2220	2220K	97.2	40.5	1.56	3 200	3 800	4.610	4.500	H320	0.27	2.4	3.6	2.5
	215	52	3.0	1320	1320K	135.0	48.0	1.74	2 800	3 200	8.640	8.530	H320	0.24	2.7	4.1	2.8
	215	73	3.0	2320	2320K	192.0	78.5	2.86	2 400	3 200	12.400	12.100	H2320	0.38	1.7	2.6	1.7





Thrust ball bearings

Thrust ball bearings

Thrust ball bearings

The single direction thrust ball bearings consist of two washers with raceways for one row of balls with a cage. The washers have flat seating surfaces. They must be supported in order to spread the load on the balls evenly. These bearings are designed to carry axial forces acting in one direction only. They cannot carry radial forces.

The double direction thrust ball bearings have two cages with balls positioned between the central shaft washer and two housing washers with flat seating surfaces. The central shaft washer has raceways for balls on both sides and is mounted on the shaft.

The double direction thrust ball bearings can carry axial loads acting in both directions. They cannot carry radial forces.

Boundary Dimensions

The boundary dimensions of the thrust ball bearings indicated in the dimension tables correspond to the international dimensional plan ISO 104.

Designation

The designation of the bearings in the basic design is indicated in the dimension tables. The differences from the basic design are designated by additional symbols in accordance with the STN 02 4608.

Cage

The thrust ball bearings have strip steel cages which are not marked. For special applications, some bearings types are available with a machined brass cage (M). Bearings with these cages are only made to order.

Tolerance

Thrust ball bearings are usually produced in normal tolerance class P0 (symbol P0 is not shown). In special cases of arrangement, demanding higher accuracy, bearings are produced in higher tolerance classes P6. Tolerances of accuracy, deviations of dimensions and operation are stated in ISO STN 199.

Misalignment

The thrust ball bearings require as accurate alignment of seating surfaces as possible. Any misalignment causes increased stress between the rolling elements and raceways contact. Therefore, the thrust ball bearings are not suitable for carrying forces under misalignment of the shaft and housing washers.

Axial Equivalent Dynamic Load

$$P_a = F_a \quad [\text{kN}]$$

Minimum Axial Load

When using the thrust ball bearings under higher rotational speeds, the sliding of the balls between the ring raceways due to centrifugal forces can occur if the axial load F_a drops below a certain minimum value determined from the following equation:

$$F_{a \min} = M \left(\frac{n_{\max}}{1000} \right)^2$$

where: $F_{a \min}$ – minimum axial load [kN]
 n_{\max} – maximum rotational speed [min⁻¹]
M – minimum axial load factor
(values are indicated in the dimension tables)

If the external axial load is low (lower than $F_{a \min}$) or if the bearing is relieved during the operation, such as when one row of balls in the double direction thrust ball bearings or one bearing in the arrangement of a single direction bearing pair is relieved, it is necessary to secure the minimum axial load, e.g. using springs.

Axial Equivalent Static Load

$$P_{oa} = F_a \quad [\text{kN}]$$

Single direction thrust ball bearings

d = 10 - 55 mm

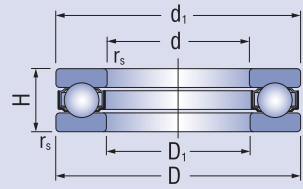

Dimensions						Designation	Basic load ratings		Fatigue load limit	Limiting speed for lubrication with		Mass
d	D	d ₁	D ₁	H	r _s min		C _r	C _{0r}		C _u	grease	
mm							kN			min ⁻¹	kg	
10	24	24	11	9	0.3	51100	10.0	14.0	0.64	6 300	9 000	0.020
	26	26	12	11	0.6	51200	12.7	17.0	0.77	6 000	8 000	0.030
12	26	26	13	9	0.3	51101	10.3	15.2	0.69	6 000	8 500	0.022
	28	28	14	11	0.6	51201	13.2	19.0	0.86	5 300	7 500	0.032
15	28	28	16	9	0.3	51102	10.5	16.8	0.76	5 600	8 000	0.024
	32	32	17	12	0.6	51202	16.5	24.8	1.13	4 800	6 700	0.044
17	30	30	18	9	0.3	51103	10.8	18.2	0.83	5 300	7 500	0.028
	35	35	19	12	0.6	51203	17.2	27.2	1.24	4 500	6 300	0.051
20	35	35	21	10	0.3	51104	14.2	24.5	1.11	4 800	6 700	0.040
	40	40	22	14	0.6	51204	22.3	37.5	1.71	3 800	5 300	0.073
25	42	42	26	11	0.6	51105	15.4	30.2	1.37	4 300	6 000	0.060
	47	47	27	15	0.6	51205	27.8	50.5	2.30	3 400	4 800	0.110
	52	52	27	18	1.0	51305	35.7	61.5	2.80	3 000	4 300	0.171
	60	60	27	24	1.0	51405	55.5	89.2	4.06	2 200	3 400	0.340
30	47	47	32	11	0.6	51106	16.0	34.2	1.55	4 000	5 600	0.068
	52	52	32	16	0.6	51206	28.1	54.2	2.46	3 200	4 500	0.138
	60	60	32	21	1.0	51306	42.8	78.5	3.58	2 400	3 600	0.265
	70	70	32	28	1.0	51406	72.7	125.8	5.73	1 900	3 000	0.360
35	52	52	37	12	0.6	51107	18.5	41.5	1.89	3 800	5 300	0.090
	62	62	37	18	1.0	51207	39.2	78.2	3.55	2 800	4 000	0.220
	68	68	37	24	1.0	51307	55.4	105.0	4.77	2 000	3 200	0.378
	80	80	37	32	1.1	51407	86.8	155.2	7.05	1 700	2 600	0.820
40	60	60	42	13	0.6	51108	26.8	62.8	2.86	3 400	4 800	0.110
	68	68	42	19	1.0	51208	47.0	98.2	4.46	2 400	3 600	0.270
	78	78	42	26	1.0	51308	69.2	135.0	6.14	1 900	3 000	0.550
	90	90	42	36	1.1	51408	112.4	205.3	9.32	1 500	2 200	1.180
45	65	65	47	14	0.6	51109	27.0	66.0	3.00	3 200	4 500	0.150
	73	73	47	20	1.0	51209	47.8	105.0	4.77	2 200	3 400	0.320
	85	85	47	28	1.0	51309	75.8	150.0	6.82	1 700	2 600	0.690
	100	100	47	39	1.1	51409	140.7	262.4	11.93	1 400	2 000	1.640
50	70	70	52	14	0.6	51110	27.1	69.2	3.15	3 000	4 300	0.160
	78	78	52	22	1.0	51210	48.5	112.0	5.09	2 000	3 200	0.390
	95	95	52	31	1.1	51310	96.5	202.0	9.18	1 600	2 400	1.000
	110	110	52	43	1.5	51410	160.0	302.0	13.73	1 300	1 900	1.860
55	78	78	57	16	0.6	51111	33.8	89.2	4.05	2 800	4 000	0.240
	90	90	57	25	1.0	51211	67.7	158.0	7.23	1 900	3 000	0.620
	105	105	57	35	1.1	51311	114.5	242.0	11.10	1 500	2 200	1.340
	120	120	57	48	1.5	51411	182.5	355.0	16.14	1 100	1 700	2.640

Single direction thrust ball bearings

d = 60 - 140 mm

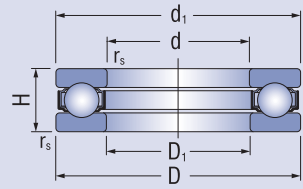

Dimensions						Designation	Basic load ratings		Fatigue load limit	Limiting speed for lubrication with		Mass
d	D	d ₁	D ₁	H	r _s min		C _r	C _{0r}		C _u	grease	
mm							kN			min ⁻¹	kg	
60	85	85	62	17	1.0	51112	40.3	108.0	4.91	2 600	3 800	0.290
	95	95	62	26	1.0	51212	73.5	178.0	8.09	1 800	2 800	0.690
	110	110	62	35	1.1	51312	118.0	262.0	11.91	1 400	2 000	1.390
	130	130	62	51	1.5	51412	200.0	395.0	17.95	1 000	1 600	3.310
65	90	90	67	18	1.0	51113	40.5	112.0	5.09	2 400	3 600	0.340
	100	100	67	27	1.0	51213	74.8	188.0	8.59	1 700	2 600	0.750
	115	115	67	36	1.1	51313	138.9	262.0	11.91	1 300	1 900	1.570
	140	140	68	56	2.0	51413	232.0	448.0	20.36	900	1 400	3.910
70	95	95	72	18	1.0	51114	40.8	115.0	5.23	2 200	3 400	0.360
	105	105	72	27	1.0	51214	73.5	188.0	8.55	1 600	2 400	0.790
	125	125	72	40	1.1	51314	148.3	340.0	15.50	1 200	1 800	1.980
	150	150	73	60	2.0	51414	257.0	565.0	24.56	850	1 300	4.850
75	100	100	77	19	1.0	51115	48.2	140.0	6.36	2 000	3 200	0.390
	110	110	77	27	1.0	51215	74.8	198.0	9.00	1 500	2 200	0.820
	135	135	77	44	1.5	51315	163.4	380.0	16.89	1 100	1 700	2.700
	160	160	78	65	2.0	51415	268.0	615.0	26.74	800	1 200	6.080
80	105	105	82	19	1.0	51116	48.8	145.0	6.59	1 900	3 000	0.430
	115	115	82	28	1.0	51216	83.8	222.0	10.09	1 400	2 000	0.925
	140	140	82	44	1.5	51316	161.1	380.0	16.89	1 000	1 600	2.800
	170	170	83	68	2.1	51416	292.0	635.0	25.81	750	1 100	7.120
85	110	110	87	19	1.0	51117	49.2	150.0	6.82	1 800	2 800	0.460
	125	125	88	31	1.0	51217	103.4	280.0	12.73	1 300	1 900	1.300
	150	150	88	49	1.5	51317	209.1	495.0	20.80	950	1 500	3.700
	180	180	88	72	2.1	51417	318.0	782.0	31.28	700	1 000	8.280
90	120	120	92	22	1.0	51118	65.0	208.0	9.24	1 700	2 600	0.680
	135	135	93	35	1.1	51218	115.0	315.0	14.00	1 200	1 800	1.770
	155	155	93	50	1.5	51318	229.8	556.4	24.38	900	1 400	3.900
	190	190	93	77	2.1	51418	325.0	825.0	31.73	670	950	9.860
100	135	135	102	25	1.0	51120	85.0	268.0	11.20	1 600	2 400	0.950
	150	150	103	38	1.1	51220	132.0	375.0	15.62	1 100	1 700	2.400
	170	170	103	55	1.5	51320	236.5	595.0	23.31	800	1 200	5.100
	210	210	103	85	3.0	51420	400.0	1080.0	39.42	600	850	13.300
110	145	145	112	25	1.0	51122	87.0	288.0	11.60	1 500	2 200	1.080
	160	160	113	38	1.1	51222	138.0	412.0	16.48	1 000	1 600	2.600
	190	190	113	63	2.0	51322	278.0	755.0	27.96	700	1 100	7.900
120	155	155	122	25	1.0	51124	89.0	310.0	12.01	1 400	2 000	1.200
	170	170	123	39	1.1	51224	154.0	470.0	17.74	950	1 500	2.900
130	170	170	132	30	1.0	51126M	104.0	350.0	12.99	1 300	1 900	1.800
	190	187	133	45	1.5	51226M	191.0	565.0	20.30	900	1 400	4.320
140	180	178	142	31	1.0	51128M	107.0	375.0	13.47	1 200	1 800	2.100
	200	197	143	46	1.5	51228M	193.0	595.0	20.74	850	1 300	4.600

Single direction thrust ball bearings

d = 150 - 400 mm

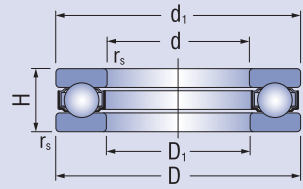

Dimensions						Designation	Basic load ratings		Fatigue load limit	Limiting speed		Mass	
d	D	d ₁	D ₁	H	r _s min		C _r	C _{0r}		C _u	for lubrication with grease	oil	kg
mm							kN			min ⁻¹			
150	190	188	152	31	1.0	51130M	109.0	400.0	13.94	1 100	1 700	2.200	
	215	212	153	50	1.5	51230M	220.0	685.0	23.04	800	1 200	6.100	
160	200	198	162	31	1.0	51132M	112.0	425.0	14.40	1 000	1 600	2.300	
	225	222	163	51	1.5	51232M	223.0	720.0	23.59	750	1 100	6.700	
170	215	213	172	34	1.0	51134M	135.0	510.0	16.71	1100	1700	2.720	
	240	237	173	55	1.5	51234M	280.0	915.0	29.04	850	1300	7.410	
180	225	222	182	34	1.1	51136M	136.0	530.0	16.93	1100	1700	2.790	
	250	247	183	56	1.5	51236M	284.0	955.0	29.60	800	1200	7.940	
190	240	237	193	37	1.1	51138M	172.0	655.0	20.30	1000	1600	3.600	
	270	267	194	62	2.1	51238M	302.0	1010.0	30.27	750	1100	11.800	
200	250	247	203	37	1.1	51140M	173.0	675.0	20.45	1000	1500	3.750	
	280	277	204	62	2.1	51240M	315.0	1110.0	32.56	710	1100	12.300	
220	270	267	223	37	1.1	51144M	179.0	740.0	21.49	950	1500	4.900	
	300	297	224	63	2.1	51244M	325.0	1210.0	34.11	670	1000	13.600	
240	300	297	243	45	1.5	51148M	229.0	935.0	25.86	850	1200	6.550	
	340	335	244	78	2.1	51248M	420.0	1650.0	44.04	560	850	23.700	
260	320	317	263	45	1.5	51152M	233.0	990.0	26.42	800	1200	7.010	
	360	355	264	79	2.1	51252M	435.0	1800.0	46.47	560	850	25.100	
280	350	347	283	53	1.5	51156M	315.0	1310.0	33.55	710	1000	12.000	
	380	375	284	80	2.1	51256M	450.0	1950.0	48.79	470	720	27.000	
300	380	376	304	62	2.1	51160M	360.0	1560.0	38.45	600	900	17.200	
	420	415	304	95	3.0	51260M	570.0	2600.0	62.28	400	600	42.500	
320	400	396	324	63	2.1	51164M	379.0	1760.0	42.16	540	810	19.000	
	440	435	325	95	3.0	51264M	577.0	2710.0	63.19	400	600	45.000	
340	420	416	344	64	2.1	51168M	387.0	1860.0	43.37	500	770	20.500	
	440	455	345	96	4.0	51268M	584.0	2830.0	65.13	380	570	48.000	
360	440	436	364	65	2.1	51172M	394.0	1960.0	44.54	500	720	21.500	
	500	495	365	110	5.0	51272M	701.0	3500.0	76.72	340	500	70.000	
380	460	456	384	65	2.1	51176M	397.0	2200.0	48.79	500	720	23.000	
	520	515	385	112	5.0	51276M	728.0	4150.0	88.92	340	500	73.000	
400	480	476	404	65	2.1	51180M	403.0	2280.0	49.40	460	700	24.000	
	540	535	405	112	5.0	51280M	761.0	4500.0	94.35	340	500	78.000	

Double-direction thrust ball bearings

d = 10 - 75 mm

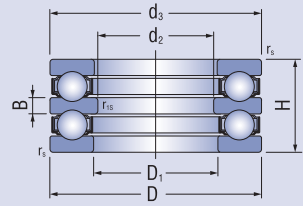

Dimensions								Designation	Basic load ratings		Fatigue load limit	Limiting speed for lubrication with		Mass
d ₂	D	d ₃	D ₁	H	B	r _s min	r _{1s} min		dynamic	static		grease	oil	
mm								C _r	C _{0r}	C _u	min ⁻¹		kg	
10	32	32	17	22	5	0.6	0.3	52202	15.4	24.0	1.09	4 800	7 100	0.081
15	40	40	22	26	6	0.6	0.3	52204	22.5	37.5	1.71	4 000	6 000	0.148
	60	60	27	45	11	1.0	0.6	52405	56.0	89.5	4.06	3 200	4 600	0.636
20	47	47	27	28	7	0.6	0.3	52205	28.0	50.5	2.30	3 400	5 300	0.213
	52	52	27	34	8	1.0	0.3	52305	36.0	61.5	2.80	3 000	4 500	0.324
	70	70	32	52	12	1.0	0.6	52406	73.0	126.0	5.73	2 700	3 500	0.970
25	52	52	32	29	7	0.6	0.3	52206	29.5	58.0	2.64	3 200	5 000	0.254
	60	60	32	38	9	1.0	0.3	52306	43.0	78.5	3.58	2 600	4 000	0.483
	80	80	37	59	14	1.1	0.6	52407	87.5	155.0	7.05	2 200	3 000	1.440
30	62	62	37	34	8	0.6	0.3	52207	39.5	78.0	3.55	2 800	4 300	0.406
	68	68	37	44	10	1.0	0.3	52307	56.0	105.0	4.77	2 400	3 600	0.710
	68	68	42	36	9	1.0	0.6	52208	46.8	106.0	4.82	2 600	4 000	0.550
	78	78	42	49	12	1.0	0.6	52308	70.0	135.0	6.14	2 000	3 000	1.040
	90	90	42	65	15	1.1	0.6	52408	103.0	188.0	8.54	1 900	2 700	1.940
35	73	73	47	37	9	1.0	0.6	52209	48.0	105.0	4.77	2 400	3 600	0.606
	85	85	47	52	12	1.0	0.6	52309	80.5	163.0	7.41	1 900	2 800	1.280
	100	100	47	72	17	1.1	0.6	52409	128.0	246.0	11.18	1 800	2 500	2.640
40	78	78	52	39	9	1.0	0.6	52210	49.0	111.0	5.05	2 400	3 400	0.697
	95	95	52	58	14	1.1	0.6	52310	97.5	202.0	9.18	1 700	2 600	1.780
	110	100	52	78	18	1.5	0.6	52410	147.0	288.0	13.09	1 600	2 400	3.510
45	90	90	57	45	10	1.0	0.6	52211	70.0	159.0	7.23	2 000	3 000	1.110
	105	105	57	64	15	1.1	0.6	52311	115.0	244.0	11.18	1 500	2 400	2.430
	120	120	57	87	20	1.5	0.6	52411	181.0	350.0	15.91	1 400	2 100	4.540
50	95	95	62	46	10	1.0	0.6	52212	71.5	169.0	7.68	1 900	3 000	1.220
	110	110	62	64	15	1.1	0.6	52312	119.0	263.0	11.95	1 500	2 200	2.590
	130	130	62	93	21	1.5	0.6	52412	202.0	395.0	17.95	1 300	1 900	5.800
55	100	100	67	47	10	1.0	0.6	52213	75.5	189.0	8.59	1 900	2 800	1.340
	115	115	67	65	15	1.1	0.6	52313	123.0	282.0	12.82	1 400	2 000	2.900
	105	105	72	47	10	1.0	1.0	52214	74.0	189.0	8.59	1 800	2 800	1.440
	125	125	72	72	16	1.1	1.0	52314	137.0	315.0	14.32	1 300	1 900	3.640
60	110	110	77	47	10	1.0	1.0	52215	78.0	209.0	9.50	1 800	2 600	1.540
	135	135	77	79	18	1.5	1.0	52315	159.0	365.0	16.59	1 200	1 800	4.720
65	115	115	82	48	10	1.0	1.0	52216	79.0	218.0	9.95	1 700	2 600	1.660
	140	140	82	79	18	1.5	1.0	52316	176.0	424.0	19.03	1 200	1 800	5.060
70	125	125	88	55	12	1.0	1.0	52217	96.0	264.0	12.00	1 500	2 200	2.260
	150	150	88	87	19	1.5	1.0	52317	206.0	489.0	21.19	1 100	1 600	6.430
75	135	135	93	62	14	1.1	1.0	52218	114.0	310.0	13.75	1 400	2 000	3.090
	155	155	93	88	19	1.5	1.0	52318	214.0	525.0	22.25	1 100	1 600	6.790

Double-direction thrust ball bearings

d = 85 - 150 mm

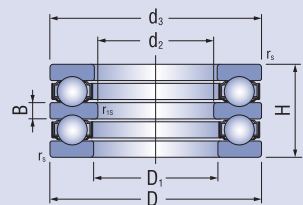

Dimensions								Designation	Basic load ratings		Fatigue load limit	Limiting speed for lubrication with		Mass
d_2	D	d_3	D_1	H	B	r_s min	r_{1s} min		dynamic	static		grease	oil	
mm								C_r	C_{or}	C_u	min ⁻¹		kg	
85	150	150	103	67	15	1.1	1.0	52220	135.0	375.0	15.72	1 300	1 900	4.080
	170	170	103	97	21	1.5	1.0	52320	239.0	595.0	23.95	950	1 500	8.820
95	160	160	113	67	15	1.1	1.0	52222	136.0	395.0	15.90	1 200	1 800	4.390
	190	189.5	113	110	24	2.1	1.0	52322	282.0	755.0	28.74	850	1 300	12.700
100	170	170	123	68	15	1.1	1.0	52224	141.0	430.0	16.82	1 200	1 800	4.920
	210	209.5	123	123	27	2.1	1.1	52324	330.0	930.0	33.95	750	1 100	17.600
110	190	189.5	133	80	18	1.5	1.1	52226M	183.0	550.0	20.41	1 000	1 500	7.430
120	200	199.5	143	81	18	1.5	1.1	52228M	186.0	575.0	20.66	1 000	1 500	8.010
130	215	214.5	153	89	20	1.5	1.1	52230M	238.0	735.0	25.43	900	1 300	10.400
140	225	224.5	163	90	20	1.5	1.1	52232M	249.0	805.0	27.08	850	1 300	11.200
150	240	239.5	173	97	21	3.0	2.1	52234M	280.0	915.0	29.78	800	1 200	13.600



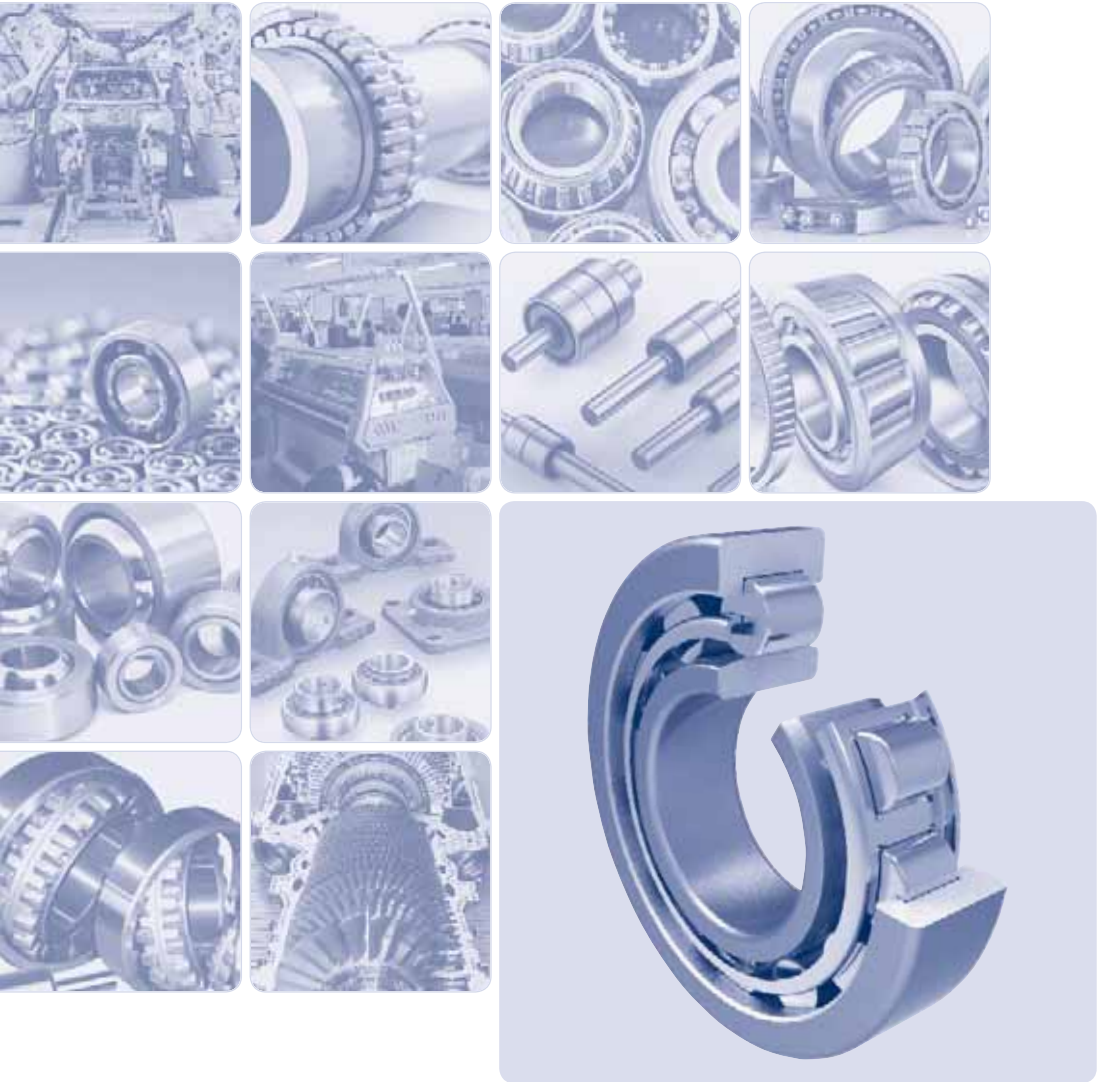

Single Row Cylindrical Roller Bearings

Single Row Cylindrical Roller Bearings

Single Row Cylindrical Roller Bearings

Single-row cylindrical roller bearings are separable and generally consist of two parts. One part is the outer or inner ring with rollers attached with a cage and guiding rings, and the second part is the separate ring. This design allows separate mounting of rings and thus simplifies handling of individual parts.

The E design is available for the whole range of roller bearings with a pressed sheet-metal cage. The E design is also available for roller bearings with plastic and brass cages.

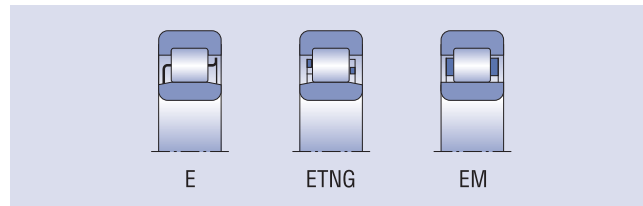

Single-row cylindrical roller bearings are capable of transmitting high radial forces in small built-in spaces. Certain designs are also capable of transmitting forces impacting from one or both directions. The raceway design of the inner and outer ring with the ZB shape of the roller surface, enables to spread the impacting forces evenly on the contact area. What's more, this design also facilitates the desirable creation of oil film between the contacting parts, optimal rolling away, reduced friction, heat generation and thus reduced stress of the bed.

Single-row cylindrical roller bearings have higher load-bearing capacity than single-row ball bearings of the same size, and are suitable for mounting with high radial load, high rotational frequency and where fixed mounting of both rings is required.

Designs

Single-row cylindrical roller bearings are made in several designs.

The NU design has rollers guided between ribs on the outer ring, while the N design has rollers guided between ribs on the inner ring. Both designs allow axial shift of the rings in both directions.

The NJ design is constructed with two guiding ribs on the outer ring and one on the inner ring. The NF design is made with two guiding ribs on the inner ring and one on the outer ring. Both designs allow transmission of a limited axial force in one direction.

Besides the elements used in the NJ design, the NUP design has an additional flat ring, functioning as the second supporting head on the inner ring and allows the bearing to transfer limited axial forces in both directions.

Axial guiding in both directions can be achieved by using HJ angle rings for NJ design bearings and axial guiding in one direction for NU design bearings. Designation of the shaped angle ring belonging to individual bearings with tapered hole are stated in dimension tables.

The individual design variants are depicted in the table part of this publication.

Basic dimensions

The basic dimensions of single-row cylindrical roller bearings stated in dimension charts comply with the international dimension plan ISO 15.

Identification

Identification of the basic design bearings is provided in the table part of the publication. Deviations from the basic designs are indicated by additional symbols in accordance with STN 02 4608. The meaning of the most commonly used symbols is provided in the following table.

Symbol	Example of designation	Meaning
R	R NU205	Bearing without one (separable) ring
L	LNU206	Removable ring of separable bearing
C3	NJ311 C3	Radial clearance greater than normal
R...	NU210 R70-90	Radial clearance in non-standardized range (range in µm)
E	NU220 E	Modification of internal design, higher load rating
M	NJ305 EM	Solid brass cage connected by rivets
M1	NJ207 EM1	Solid brass cage connected without rivets
TNG	NU306 ETNG	Solid polyamide cage centered on cylindrical roller
N	NU207 N	Snap ring groove on outer ring
NR	NU206 NR	Snap ring groove on outer ring and inserted snap ring
P6	NU217 P6	Tolerance class higher than normal
S0	NU220 C3S0	Stabilization for operation at temperature up to 150 °C
S1	NU220 C3S1	Stabilization for operation at temperature up to 200 °C
S2	NU220 C3S2	Stabilization for operation at temperature up to 250 °C

Cages

Single-row roller bearings are made with a sheet-metal steel cage guided on rollers, which is not marked.

Bearings for special mounting applications are made with plastic or brass cages.

The additional symbol for plastic cages, TNG means that the cage is made as a single part from polyamide PA 6.6., reinforced with 25% of glass fibre.

Brass cages are manufactured in two designs – M with the brass cage joint with steel rivets and M1 with the cage flange and body joint with pressed-out legs.

If the brass cage is to be guided on the outer MA ring or the inner MB ring, the delivery of bearings must be discussed in advance.

The symbols for the cage material and design are stated in the table part of this publication.

Tolerances

Bearings are commonly produced in normal tolerance class P0 which is not indicated. Bearings for more demanding arrangements are delivered in tolerance classes P6, P5 and P4.

Radial Clearance

Commonly produced bearings have normal radial clearance which is not indicated. For special arrangements bearings with smaller clearance C2 or greater radial clearance C3, C4 and C5 are delivered.

The symbols for a tolerance class and radial clearance are grouped together in the basic designation, e. g.:

P6 + C3 = P63

P6 + C4 = P64 etc.

Bearings with Angle Rings

Angle rings – type HJ2, HJ2E, HJ3, HJ3E and HJ4 can be used for bearings in NJ and NU designs.

Examples of bearing designation:

NJ2 + HJ2 = NH2	NU2 + HJ2 = NUJ2
NJ3 + HJ3 = NH3	NU3 + HJ3 = NUJ3
NJ4 + HJ4 = NH4	NU4 + HJ4 = NUJ4

Pictures of individual basic designs and combinations are in the dimension tables of this publication.

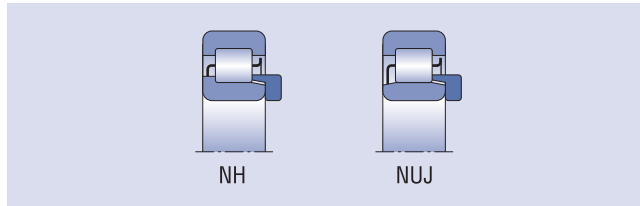

Bearings without Inner Ring

Single row cylindrical roller bearings without inner ring designated R NU are delivered for arrangements with limited space for bearing mounting.

The hardened and grinded pin is the inner bearing ring raceway.

Dimension tolerance on the pin is usually “g6” for normal radial clearance, “f6” for greater radial clearance and “h5” for smaller radial clearance. Ovality and cylindricity deviations of the “raceway” on this pin can not be greater than deviations for tolerance class IT3. Surface roughness for this surface should be $R_a = 0.2$ and for less demanding arrangements $R_a = 0.4$.

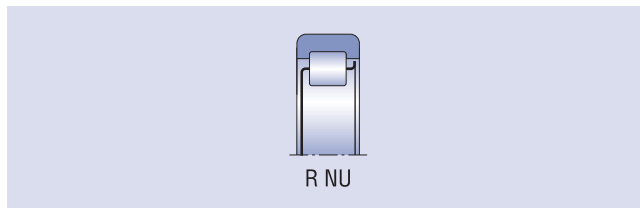

Basic load rating C_r and C_{or} values shown in the dimension tables, are valid for bearings RNU if the pin surface hardness will be in the range 59 to 65 HRC. With decreasing hardness value, the load rating values C_r decreases as well. It must be multiplied by the factor f_h from the following table. Minimum depth of pin hardening after grinding depends on the cylindrical roller diameter and load magnitude and should be 1 to 3 mm.

Hardness HRC	58	56	54	51	48	45	40	35	30
Factor f_h	0.9	0.8	0.7	0.6	0.5	0.4	0.3	0.25	0.2

Misalignment

Mutual bearing ring misalignment of single row cylindrical roller bearings is very small. Permissible misalignment values are in the table.

Bearing	Type Load	
	small ($F_r < 0,1C_{or}$)	great ($F_r \geq 0,1C_{or}$)
NU10, NU2, NU3, NU4	2' – 3'	5' – 7'
NU22, NU23	1' – 3'	3' – 4'
Designs NJ, NUP, N ¹⁾ of all dimension series	1' – 2'	3' – 4'

¹⁾ Smaller values of the number pair are valid for bearings of width series 2 and higher

Dynamic equivalent radial load

The dynamic load for single-row cylindrical roller bearings with radial load only and without axial forces is calculated according to the following formula:

$$P_r = F_r \quad [\text{kN}]$$

If roller bearings are also used to transmit axial forces, the dynamic load is calculated according to the following formula:

$$P_r = F_r \quad \text{for } F_a/F_r \leq e$$

$$P_r = 0,92 F_r + Y \cdot F_a \quad \text{for } F_a/F_r > e$$

where

- e = calculation coefficient
- e = 0.2 for 2, 3, 4 grade roller bearings
- e = 0.3 for 22, 23 grade roller bearings

- Y = axial load coefficient
- Y = 0.6 for 2, 3, 4 grade roller bearings
- Y = 0.4 for 22, 23 grade roller bearings

To ensure reliable operation of cylindrical roller bearings transmitting axial load, simultaneous load with a radial force must be ensured and the ratio F_a/F_r should not be greater than 0.5.

Static equivalent radial load

The following applies for cylindrical roller bearings under static load:

$$P_{or} = F_r \quad [\text{kN}]$$

Single Row Cylindrical Roller Bearings

d = 17 - 20 mm

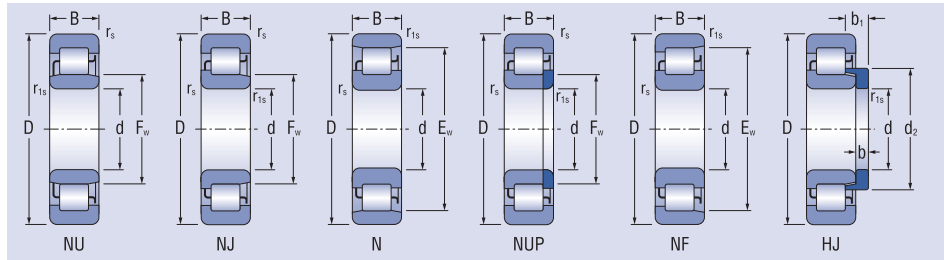

Dimensions	Bearing designation						Basic load rating dynamic	static	Fatigue load limit	Limiting speed for lubrication with		Mass of Bearings	Separate Thrust Collar	Mass of separate Thrust Collar	
	d	D	B	r _s min	r _{s1} min	F _w				E _w	C _r				C _{0r}
mm											min ⁻¹				
17	40	12	0.6	0.3	22.1	-	NU203EM	14.7	11.5	1.41	15 000	18 000	0.08	HJ203	0.009
	40	12	0.6	0.3	22.1	-	NJ203EM	14.7	11.5	1.41	15 000	18 000	0.08	HJ203	0.009
	40	12	0.6	0.3	22.1	-	NUP203EM	14.7	11.5	1.41	15 000	18 000	0.08	-	-
	40	12	0.6	0.3	-	35.1	N203EM	14.7	11.5	1.41	15 000	18 000	0.08	-	-
	40	12	0.6	0.3	-	35.1	NF203EM	14.7	11.5	1.41	15 000	18 000	0.08	-	-
	40	12	0.6	0.3	22.1	-	NU203EM1	15.7	12.6	1.54	15 000	18 000	0.08	HJ203	0.009
	40	12	0.6	0.3	22.1	-	NJ203EM1	15.7	12.6	1.54	15 000	18 000	0.08	HJ203	0.009
	40	12	0.6	0.3	22.1	-	NUP203EM1	15.7	12.6	1.54	15 000	18 000	0.08	-	-
	40	12	0.6	0.3	-	35.1	N203EM1	15.7	12.6	1.54	15 000	18 000	0.08	-	-
	40	12	0.6	0.3	-	35.1	NF203EM1	15.7	12.6	1.54	15 000	18 000	0.08	-	-
	40	16	0.6	0.3	22.1	-	NU2203EM1	20.9	18.1	2.21	15 000	18 000	0.103	HJ2203	0.010
	40	16	0.6	0.3	22.1	-	NJ2203EM1	20.9	18.1	2.21	15 000	18 000	0.103	HJ2203	0.010
	40	16	0.6	0.3	22.1	-	NUP2203EM1	20.9	18.1	2.21	15 000	18 000	0.103	-	-
	40	16	0.6	0.3	-	35.1	N2203EM1	20.9	18.1	2.21	15 000	18 000	0.103	-	-
	40	16	0.6	0.3	-	35.1	NF2203EM1	20.9	18.1	2.21	15 000	18 000	0.103	-	-
	47	14	1.0	0.6	24.2	-	NU303EM1	21.6	17.1	2.09	14 000	17 000	0.110	HJ303	0.012
	47	14	1.0	0.6	24.2	-	NJ303EM1	21.6	17.1	2.09	14 000	17 000	0.110	HJ303	0.012
	47	14	1.0	0.6	24.2	-	NUP303EM1	21.6	17.1	2.09	14 000	17 000	0.110	-	-
	47	14	1.0	0.6	-	40.2	N303EM1	21.6	17.1	2.09	14 000	17 000	0.110	-	-
	47	14	1.0	0.6	-	40.2	NF303EM1	21.6	17.1	2.09	14 000	17 000	0.110	-	-
60	17	1.1	0.6	-	-	NU403EM	24.3	20.6	2.51	12 000	14 000	0.336	HJ403	0.030	
60	17	1.1	0.6	-	-	NJ403EM	24.3	20.6	2.51	12 000	14 000	0.336	HJ403	0.030	
60	17	1.1	0.6	-	-	NUP403EM	24.3	20.6	2.51	12 000	14 000	0.336	-	-	
60	17	1.1	0.6	-	-	N403EM	24.3	20.6	2.51	12 000	14 000	0.336	-	-	
60	17	1.1	0.6	-	-	NF403EM	24.3	20.6	2.51	12 000	14 000	0.336	-	-	
20	47	14	1.1	0.6	26.5	-	NU204EM	22.6	19.0	2.31	14 000	17 000	0.112	HJ204	0.012
	47	14	1.1	0.6	26.5	-	NJ204EM	22.6	19.0	2.31	14 000	17 000	0.112	HJ204	0.012
	47	14	1.1	0.6	26.5	-	NUP204EM	22.6	19.0	2.31	14 000	17 000	0.112	-	-
	47	14	1.1	0.6	-	41.5	N204EM	22.6	19.0	2.31	14 000	17 000	0.112	-	-
	47	14	1.1	0.6	-	41.5	NF204EM	22.6	19.0	2.31	14 000	17 000	0.112	-	-
	47	14	1.1	0.6	26.5	-	NU204EM1	26.2	23.2	2.83	14 000	17 000	0.112	HJ204	0.012
	47	14	1.1	0.6	26.5	-	NJ204EM1	26.2	23.2	2.83	14 000	17 000	0.112	HJ204	0.012
	47	14	1.1	0.6	26.5	-	NUP204EM1	26.2	23.2	2.83	14 000	17 000	0.112	-	-
	47	14	1.1	0.6	-	41.5	N204EM1	26.2	23.2	2.83	14 000	17 000	0.112	-	-
	47	14	1.1	0.6	-	41.5	NF204EM1	26.2	23.2	2.83	14 000	17 000	0.112	-	-
	47	18	1.1	0.6	26.5	-	NU2204EM1	31.1	28.9	3.52	14 000	17 000	0.150	HJ2204	0.012
	47	18	1.1	0.6	26.5	-	NJ2204EM1	31.1	28.9	3.52	14 000	17 000	0.150	HJ2204	0.012
	47	18	1.1	0.6	26.5	-	NUP2204EM1	31.1	28.9	3.52	14 000	17 000	0.150	-	-
	47	18	1.1	0.6	-	41.5	N2204EM1	31.1	28.9	3.52	14 000	17 000	0.150	-	-
	47	18	1.1	0.6	-	41.5	NF2204EM1	31.1	28.9	3.52	14 000	17 000	0.150	-	-
	52	15	1.1	0.6	27.5	-	NU304E	26.7	21.5	2.62	13 000	16 000	0.153	HJ304	0.018
	52	15	1.1	0.6	27.5	-	NJ304E	26.7	21.5	2.62	13 000	16 000	0.153	HJ304	0.018

Single Row Cylindrical Roller Bearings

d = 20 - 25 mm

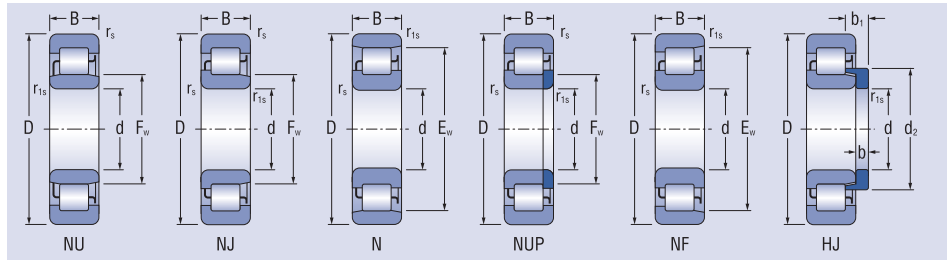

Dimensions							Bearing designation	Basic load rating		Fatigue load limit	Limiting speed for lubrication with		Mass of Bearings	Separate Thrust Collar	Mass of separate Thrust Collar
d	D	B	r _s min	r _{s1} min	F _w	E _w		C _r	C _{0r}		grease	oil			
mm							kN			min ⁻¹					
20	52	15	1.1	0.6	27.5	-	NUP304E	26.7	21.5	2.62	13 000	16 000	0.153	-	-
	52	15	1.1	0.6	-	45.5	N304E	29.1	24.2	2.95	13 000	16 000	0.153	-	-
	52	15	1.1	0.6	-	45.5	NF304E	26.7	21.5	2.62	13 000	16 000	0.153	-	-
	52	15	1.1	0.6	27.5	-	NU304ETNG	31.5	27.0	3.29	13 000	16 000	0.153	HJ304	0.018
	52	15	1.1	0.6	27.5	-	NJ304ETNG	31.5	27.0	3.29	13 000	16 000	0.153	HJ304	0.018
	52	15	1.1	0.6	27.5	-	NUP304ETNG	31.5	27.0	3.29	13 000	16 000	0.153	-	-
	52	15	1.1	0.6	-	45.5	N304ETNG	31.5	27.0	3.29	13 000	16 000	0.153	-	-
	52	15	1.1	0.6	-	45.5	NF304ETNG	31.5	27.0	3.29	13 000	16 000	0.153	-	-
	52	15	1.1	0.6	27.5	-	NU304EM1	31.5	27.0	3.29	13 000	16 000	0.153	HJ304	0.018
	52	15	1.1	0.6	27.5	-	NJ304EM1	31.5	27.0	3.29	13 000	16 000	0.153	HJ304	0.018
	52	15	1.1	0.6	27.5	-	NUP304EM1	31.5	27.0	3.29	13 000	16 000	0.153	-	-
	52	15	1.1	0.6	-	45.5	N304EM1	31.5	27.0	3.29	13 000	16 000	0.153	-	-
	52	15	1.1	0.6	-	45.5	NF304EM1	31.5	27.0	3.29	13 000	16 000	0.153	-	-
	52	21	1.1	0.6	27.5	-	NU2304EM1	41.9	38.8	4.73	12 000	14 000	0.219	HJ2304	0.019
	52	21	1.1	0.6	27.5	-	NJ2304EM1	41.9	38.8	4.73	12 000	14 000	0.219	HJ2304	0.019
	25	52	15	1.1	0.6	31.5	-	NU205E	25.9	23.5	2.86	12 000	15 000	0.135	HJ205
52		15	1.1	0.6	31.5	-	NJ205E	25.9	23.5	2.86	12 000	15 000	0.135	HJ205	0.014
52		15	1.1	0.6	31.5	-	NUP205E	25.9	23.5	2.86	12 000	15 000	0.135	-	-
52		15	1.1	0.6	-	46.5	N205E	25.9	23.5	2.86	12 000	15 000	0.135	-	-
52		15	1.1	0.6	-	46.5	NF205E	25.9	23.5	2.86	12 000	15 000	0.135	-	-
52		15	1.1	0.6	31.5	-	NU205ETNG	28.2	26.2	3.20	12 000	15 000	0.135	HJ205	0.014
52		15	1.1	0.6	31.5	-	NJ205ETNG	28.2	26.2	3.20	12 000	15 000	0.135	HJ205	0.014
52		15	1.1	0.6	31.5	-	NUP205ETNG	28.2	26.2	3.20	12 000	15 000	0.135	-	-
52		15	1.1	0.6	-	46.5	N205ETNG	28.2	26.2	3.20	12 000	15 000	0.135	-	-
52		15	1.1	0.6	-	46.5	NF205ETNG	28.2	26.2	3.20	12 000	15 000	0.135	-	-
52		15	1.1	0.6	31.5	-	NU205EM1	28.2	26.2	3.20	12 000	15 000	0.135	HJ205	0.014
52		15	1.1	0.6	31.5	-	NJ205EM1	28.2	26.2	3.20	12 000	15 000	0.135	HJ205	0.014
52		15	1.1	0.6	31.5	-	NUP205EM1	28.2	26.2	3.20	12 000	15 000	0.135	-	-
52		15	1.1	0.6	-	46.5	N205EM1	28.2	26.2	3.20	12 000	15 000	0.135	-	-
52		15	1.1	0.6	-	46.5	NF205EM1	28.2	26.2	3.20	12 000	15 000	0.135	-	-
52		18	1.1	0.6	31.5	-	NU2205E	29.1	27.2	3.32	12 000	15 000	0.169	HJ2205	0.015
52	18	1.1	0.6	31.5	-	NJ2205E	29.1	27.2	3.32	12 000	15 000	0.169	HJ2205	0.015	
52	18	1.1	0.6	31.5	-	NUP2205E	29.1	27.2	3.32	12 000	15 000	0.169	-	-	
52	18	1.1	0.6	-	46.5	N2205E	31.3	29.9	3.64	12 000	15 000	0.169	-	-	
52	18	1.1	0.6	-	46.5	NF2205E	29.1	27.2	3.32	12 000	15 000	0.169	-	-	
52	18	1.1	0.6	31.5	-	NU2205ETNG	35.4	35.3	4.31	12 000	15 000	0.169	HJ2205	0.015	
52	18	1.1	0.6	31.5	-	NJ2205ETNG	35.4	35.3	4.31	12 000	15 000	0.169	HJ2205	0.015	
52	18	1.1	0.6	31.5	-	NUP2205ETNG	35.4	35.3	4.31	12 000	15 000	0.169	-	-	
52	18	1.1	0.6	-	46.5	N2205ETNG	35.4	35.3	4.31	12 000	15 000	0.169	-	-	

Single Row Cylindrical Roller Bearings

d = 25 mm

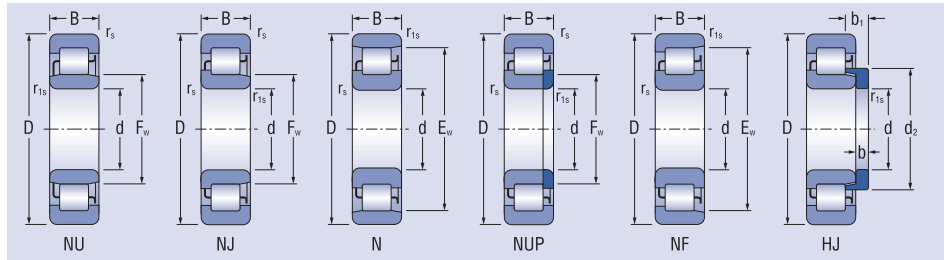

Dimensions							Bearing designation	Basic load rating		Fatigue load limit	Limiting speed		Mass of Bearings	Separate Thrust Collar	Mass of separate Thrust Collar
d	D	B	r _s min	r _{s1} min	F _w	E _w		C _r	C _{0r}		grease	oil			
mm							kN			min ⁻¹					
25	52	18	1.1	0.6	-	46.5	NF2205ETNG	35.4	35.3	4.31	12 000	15 000	0.169	-	-
	52	18	1.1	0.6	31.5	-	NU2205EM1	33.4	32.6	3.98	12 000	15 000	0.169	HJ2205	0.015
	52	18	1.1	0.6	31.5	-	NJ2205EM1	33.4	32.6	3.98	12 000	15 000	0.169	HJ2205	0.015
	52	18	1.1	0.6	-	46.5	NUP2205EM1	33.4	32.6	3.98	12 000	15 000	0.169	-	-
	52	18	1.1	0.6	-	46.5	N2205EM1	33.4	32.6	3.98	12 000	15 000	0.169	-	-
	52	18	1.1	0.6	-	46.5	NF2205EM1	33.4	32.6	3.98	12 000	15 000	0.169	-	-
	62	17	1.1	1.1	34.0	-	NU305E	35.8	30.6	3.73	10 000	12 000	0.245	HJ305	0.025
	62	17	1.1	1.1	34.0	-	NJ305E	35.8	30.6	3.73	10 000	12 000	0.245	HJ305	0.025
	62	17	1.1	1.1	34.0	-	NUP305E	35.8	30.6	3.73	10 000	12 000	0.245	-	-
	62	17	1.1	1.1	-	54.0	N305E	38.7	34.0	4.15	10 000	12 000	0.245	-	-
	62	17	1.1	1.1	-	54.0	NF305E	35.8	30.6	3.73	10 000	12 000	0.245	-	-
	62	17	1.1	1.1	34.0	-	NU305ETNG	41.6	37.4	4.56	10 000	12 000	0.245	HJ305	0.025
	62	17	1.1	1.1	34.0	-	NJ305ETNG	41.6	37.4	4.56	10 000	12 000	0.245	HJ305	0.025
	62	17	1.1	1.1	34.0	-	NUP305ETNG	41.6	37.4	4.56	10 000	12 000	0.245	-	-
	62	17	1.1	1.1	-	54.0	N305ETNG	41.6	37.4	4.56	10 000	12 000	0.245	-	-
	62	17	1.1	1.1	-	54.0	NF305ETNG	41.6	37.4	4.56	10 000	12 000	0.245	-	-
	62	17	1.1	1.1	34.0	-	NU305EM1	41.6	37.4	4.56	10 000	12 000	0.245	HJ305	0.025
	62	17	1.1	1.1	34.0	-	NJ305EM1	41.6	37.4	4.56	10 000	12 000	0.245	HJ305	0.025
	62	17	1.1	1.1	34.0	-	NUP305EM1	41.6	37.4	4.56	10 000	12 000	0.245	-	-
	62	17	1.1	1.1	-	54.0	N305EM1	41.6	37.4	4.56	10 000	12 000	0.245	-	-
	62	17	1.1	1.1	-	54.0	NF305EM1	41.6	37.4	4.56	10 000	12 000	0.245	-	-
	62	24	1.1	0.6	34.0	-	NU2305E	48.8	45.3	5.52	10 000	12 000	0.356	HJ2305	0.027
	62	24	1.1	0.6	34.0	-	NJ2305E	48.8	45.3	5.52	10 000	12 000	0.356	HJ2305	0.027
	62	24	1.1	0.6	34.0	-	NUP2305E	48.8	45.3	5.52	10 000	12 000	0.356	-	-
	62	24	1.1	0.6	-	54.0	N2305E	48.8	45.3	5.52	10 000	12 000	0.356	-	-
	62	24	1.1	0.6	-	54.0	NF2305E	48.8	45.3	5.52	10 000	12 000	0.356	-	-
	62	24	1.1	0.6	34.0	-	NU2305ETNG	57.0	56.0	6.83	10 000	12 000	0.356	HJ2305	0.027
	62	24	1.1	0.6	34.0	-	NJ2305ETNG	57.0	56.0	6.83	10 000	12 000	0.356	HJ2305	0.027
	62	24	1.1	0.6	34.0	-	NUP2305ETNG	57.0	56.0	6.83	10 000	12 000	0.356	-	-
	62	24	1.1	0.6	-	54.0	N2305ETNG	57.0	56.0	6.83	10 000	12 000	0.356	-	-
	62	24	1.1	0.6	-	54.0	NF2305ETNG	57.0	56.0	6.83	10 000	12 000	0.356	-	-
	62	24	1.1	0.6	34.0	-	NU2305EM1	57.0	56.0	6.83	10 000	12 000	0.356	HJ2305	0.027
	62	24	1.1	0.6	34.0	-	NJ2305EM1	57.0	56.0	6.83	10 000	12 000	0.356	HJ2305	0.027
	62	24	1.1	0.6	34.0	-	NUP2305EM1	57.0	56.0	6.83	10 000	12 000	0.356	-	-
	62	24	1.1	0.6	-	54.0	N2305EM1	57.0	56.0	6.83	10 000	12 000	0.356	-	-
	62	24	1.1	0.6	-	54.0	NF2305EM1	57.0	56.0	6.83	10 000	12 000	0.356	-	-
	80	21	1.1	1.1	39.5	-	NU405EM	53.4	45.7	5.57	8 000	9 500	0.532	HJ405	0.050
	80	21	1.1	1.1	39.5	-	NJ405EM	53.4	45.7	5.57	8 000	9 500	0.532	HJ405	0.050
	80	21	1.1	1.1	39.5	-	N405EM	53.4	45.7	5.57	8 000	9 500	0.532	-	-
	80	21	1.1	1.1	-	65.5	NUP405EM	53.4	45.7	5.57	8 000	9 500	0.532	-	-
80	21	1.1	1.1	-	65.5	NF405EM	53.4	45.7	5.57	8 000	9 500	0.532	-	-	

Single Row Cylindrical Roller Bearings

d = 30 mm

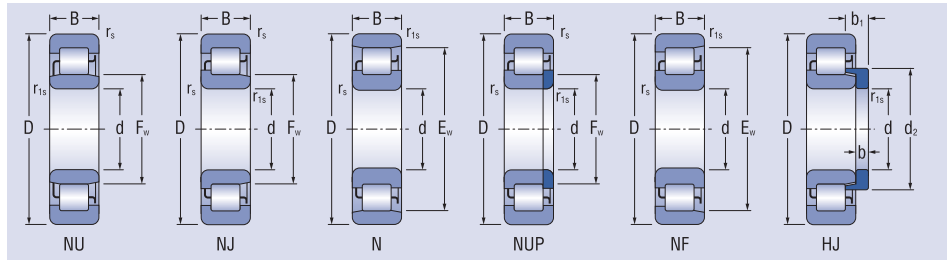

Dimensions							Bearing designation	Basic load rating		Fatigue load limit	Limiting speed		Mass of Bearings	Separate Thrust Collar	Mass of separate Thrust Collar
d	D	B	r _s min	r _{s1} min	F _w	E _w		C _r	C _{0r}		grease	oil			
mm	mm	mm	mm	mm	mm	mm	kN	kN	kN	min ⁻¹	min ⁻¹	kg	kg	kg	
30	62	16	1.1	0.6	37.5	-	NU206E	34.5	31.6	3.80	9 500	12 000	0.205	HJ206	0.025
	62	16	1.1	0.6	37.5	-	NJ206E	34.5	31.6	3.80	9 500	12 000	0.205	HJ206	0.025
	62	16	1.1	0.6	37.5	-	NUP206E	34.5	31.6	3.80	9 500	12 000	0.205	-	-
	62	16	1.1	0.6	-	55.5	N206E	36.8	34.5	4.20	9 500	12 000	0.205	-	-
	62	16	1.1	0.6	-	55.5	NF206E	34.5	31.6	3.80	9 500	12 000	0.205	-	-
	62	16	1.1	0.6	37.5	-	NU206ETNG	39.1	37.4	4.56	9 500	12 000	0.205	HJ206	0.025
	62	16	1.1	0.6	37.5	-	NJ206ETNG	39.1	37.4	4.56	9 500	12 000	0.205	HJ206	0.025
	62	16	1.1	0.6	37.5	-	NUP206ETNG	39.1	37.4	4.56	9 500	12 000	0.205	-	-
	62	16	1.1	0.6	-	55.5	N206ETNG	39.1	37.4	4.56	9 500	12 000	0.205	-	-
	62	16	1.1	0.6	-	55.5	NF206ETNG	39.1	37.4	4.56	9 500	12 000	0.205	-	-
	62	16	1.1	0.6	37.5	-	NU206EM1	39.1	37.4	4.56	9 500	12 000	0.205	HJ206	0.025
	62	16	1.1	0.6	37.5	-	NJ206EM1	39.1	37.4	4.56	9 500	12 000	0.205	HJ206	0.025
	62	16	1.1	0.6	37.5	-	NUP206EM1	39.1	37.4	4.56	9 500	12 000	0.205	-	-
	62	16	1.1	0.6	-	55.5	N206EM1	39.1	37.4	4.56	9 500	12 000	0.205	-	-
	62	16	1.1	0.6	-	55.5	NF206EM1	39.1	37.4	4.56	9 500	12 000	0.205	-	-
	62	20	1.1	0.6	37.5	-	NU2206E	43.1	42.1	5.14	9 400	12 000	0.261	HJ2206	0.026
	62	20	1.1	0.6	37.5	-	NJ2206E	43.1	42.1	5.14	9 400	12 000	0.261	HJ2206	0.026
	62	20	1.1	0.6	37.5	-	NUP2206E	43.1	42.1	5.14	9 400	12 000	0.261	-	-
	62	20	1.1	0.6	-	55.5	N2206E	46.1	46.0	5.61	9 400	12 000	0.261	-	-
	62	20	1.1	0.6	-	55.5	NF2206E	43.1	42.1	5.14	9 400	12 000	0.261	-	-
	62	20	1.1	0.6	37.5	-	NU2206ETNG	48.9	49.8	6.08	9 400	12 000	0.261	HJ2206	0.026
	62	20	1.1	0.6	37.5	-	NJ2206ETNG	48.9	49.8	6.08	9 400	12 000	0.261	HJ2206	0.026
	62	20	1.1	0.6	37.5	-	NUP2206ETNG	48.9	49.8	6.08	9 400	12 000	0.261	-	-
	62	20	1.1	0.6	-	55.5	N2206ETNG	48.9	49.8	6.08	9 400	12 000	0.261	-	-
	62	20	1.1	0.6	-	55.5	NF2206ETNG	48.9	49.8	6.08	9 400	12 000	0.261	-	-
	62	20	1.1	0.6	37.5	-	NU2206EM1	46.1	46.0	5.61	9 400	12 000	0.261	HJ2206	0.026
	62	20	1.1	0.6	37.5	-	NJ2206EM1	46.1	46.0	5.61	9 400	12 000	0.261	HJ2206	0.026
	62	20	1.1	0.6	37.5	-	NUP2206EM1	46.1	46.0	5.61	9 400	12 000	0.261	-	-
	62	20	1.1	0.6	-	55.5	N2206EM1	46.1	46.0	5.61	9 400	12 000	0.261	-	-
	62	20	1.1	0.6	-	55.5	NF2206EM1	46.1	46.0	5.61	9 400	12 000	0.261	-	-
	72	19	1.1	1.1	40.5	-	NU306E	42.8	37.7	4.60	8 400	10 000	0.368	HJ306	0.042
	72	19	1.1	1.1	40.5	-	NJ306E	42.8	37.7	4.60	8 400	10 000	0.368	HJ306	0.042
	72	19	1.1	1.1	40.5	-	NUP306E	42.8	37.7	4.60	8 400	10 000	0.368	-	-
	72	19	1.1	1.1	-	62.5	N306E	46.3	41.9	5.11	8 400	10 000	0.368	-	-
	72	19	1.1	1.1	-	62.5	NF306E	42.8	37.7	4.60	8 400	10 000	0.368	-	-
	72	19	1.1	1.1	40.5	-	NU306ETNG	53.1	50.2	6.13	8 400	10 000	0.368	HJ306	0.042
	72	19	1.1	1.1	40.5	-	NJ306ETNG	53.1	50.2	6.13	8 400	10 000	0.368	HJ306	0.042
	72	19	1.1	1.1	40.5	-	NUP306ETNG	53.1	50.2	6.13	8 400	10 000	0.368	-	-
	72	19	1.1	1.1	-	62.5	N306ETNG	53.1	50.2	6.13	8 400	10 000	0.368	-	-
	72	19	1.1	1.1	-	62.5	NF306ETNG	53.1	50.2	6.13	8 400	10 000	0.368	-	-
	72	19	1.1	1.1	40.5	-	NU306EM1	53.1	50.2	6.13	8 400	10 000	0.368	HJ306	0.042
	72	19	1.1	1.1	40.5	-	NJ306EM1	53.1	50.2	6.13	8 400	10 000	0.368	HJ306	0.042

Single Row Cylindrical Roller Bearings

d = 30 - 35 mm

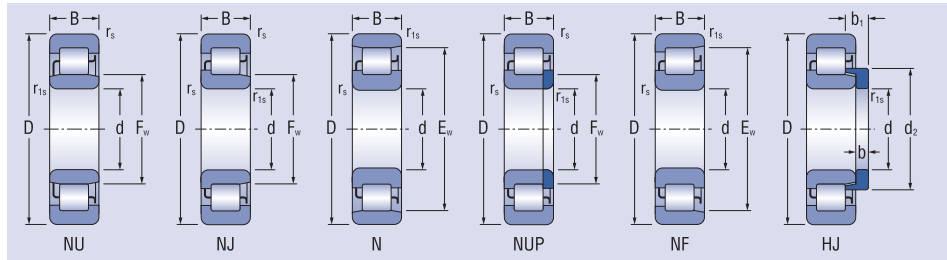

Dimensions							Bearing designation	Basic load rating		Fatigue load limit	Limiting speed		Mass of Bearings	Separate Thrust Collar	Mass of separate Thrust Collar
d	D	B	r _s min	r _{s1} min	F _w	E _w		C _r	C _{0r}		grease	oil			
mm							kN			min ⁻¹					
30	72	19	1.1	1.1	40.5	-	NUP306EM1	53.1	50.2	6.13	8 400	10 000	0.368	-	-
	72	19	1.1	1.1	-	62.5	N306EM1	53.1	50.2	6.13	8 400	10 000	0.368	-	-
	72	19	1.1	1.1	-	62.5	NF306EM1	53.1	50.2	6.13	8 400	10 000	0.368	-	-
	72	27	1.1	1.1	40.5	-	NU2306E	60.2	58.2	7.10	8 400	10 000	0.540	HJ2306	0.043
	72	27	1.1	1.1	40.5	-	NJ2306E	60.2	58.2	7.10	8 400	10 000	0.540	HJ2306	0.043
	72	27	1.1	1.1	40.5	-	NUP2306E	60.2	58.2	7.10	8 400	10 000	0.540	-	-
	72	27	1.1	1.1	-	62.5	N2306E	60.2	58.2	7.10	8 400	10 000	0.540	-	-
	72	27	1.1	1.1	-	62.5	NF2306E	60.2	58.2	7.10	8 400	10 000	0.540	-	-
	72	27	1.1	1.1	40.5	-	NU2306ETNG	74.6	77.7	9.47	8 400	10 000	0.540	HJ2306	0.043
	72	27	1.1	1.1	40.5	-	NJ2306ETNG	74.6	77.7	9.47	8 400	10 000	0.540	HJ2306	0.043
	72	27	1.1	1.1	40.5	-	NUP2306ETNG	74.6	77.7	9.47	8 400	10 000	0.540	-	-
	72	27	1.1	1.1	-	62.5	N2306ETNG	74.6	77.7	9.47	8 400	10 000	0.540	-	-
	72	27	1.1	1.1	-	62.5	NF2306ETNG	74.6	77.7	9.47	8 400	10 000	0.540	-	-
	72	27	1.1	1.1	40.5	-	NU2306EM	65.1	64.7	7.89	8 400	10 000	0.540	HJ2306	0.043
	72	27	1.1	1.1	40.5	-	NJ2306EM	65.1	64.7	7.89	8 400	10 000	0.540	HJ2306	0.043
	72	27	1.1	1.1	40.5	-	NUP2306EM	65.1	64.7	7.89	8 400	10 000	0.540	-	-
	72	27	1.1	1.1	-	62.5	N2306EM	65.1	64.7	7.89	8 400	10 000	0.540	-	-
	72	27	1.1	1.1	-	62.5	NF2306EM	65.1	64.7	7.89	8 400	10 000	0.540	-	-
	72	27	1.1	1.1	40.5	-	NU2306EM1	74.6	77.7	9.47	8 400	10 000	0.540	HJ2306	0.043
	72	27	1.1	1.1	40.5	-	NJ2306EM1	74.6	77.7	9.47	8 400	10 000	0.540	HJ2306	0.043
	72	27	1.1	1.1	40.5	-	NUP2306EM1	74.6	77.7	9.47	8 400	10 000	0.540	-	-
72	27	1.1	1.1	-	62.5	N2306EM1	74.6	77.7	9.47	8 400	10 000	0.540	-	-	
72	27	1.1	1.1	-	62.5	NF2306EM1	74.6	77.7	9.47	8 400	10 000	0.540	-	-	
90	23	1.5	1.5	45.0	-	NU406EM	65.6	58.4	7.12	7 300	8 500	0.910	HJ406	0.080	
90	23	1.5	1.5	45.0	-	NJ406EM	65.6	58.4	7.12	7 300	8 500	0.910	HJ406	0.080	
90	23	1.5	1.5	45.0	-	NUP406EM	65.6	58.4	7.12	7 300	8 500	0.910	-	-	
90	23	1.5	1.5	-	73.0	N406EM	65.6	58.4	7.12	7 300	8 500	0.910	-	-	
90	23	1.5	1.5	-	73.0	NF406EM	65.6	58.4	7.12	7 300	8 500	0.910	-	-	
35	72	17	1.1	0.6	44	-	NU207E	44.8	43.0	5.25	8 000	10 000	0.301	HJ207	0.034
	72	17	1.1	0.6	44	-	NJ207E	44.8	43.0	5.25	8 000	10 000	0.301	HJ207	0.034
	72	17	1.1	0.6	44	-	NUP207E	44.8	43.0	5.25	8 000	10 000	0.301	-	-
	72	17	1.1	0.6	-	64	N207E	44.8	43.0	5.25	8 000	10 000	0.301	-	-
	72	17	1.1	0.6	-	64	NF207E	44.8	43.0	5.25	8 000	10 000	0.301	-	-
	72	17	1.1	0.6	44	-	NU207ETNG	50.3	50.2	6.12	8 000	10 000	0.301	HJ207	0.034
	72	17	1.1	0.6	44	-	NJ207ETNG	50.3	50.2	6.12	8 000	10 000	0.301	HJ207	0.034
	72	17	1.1	0.6	44	-	NUP207ETNG	50.3	50.2	6.12	8 000	10 000	0.301	-	-
	72	17	1.1	0.6	-	64	N207ETNG	50.3	50.2	6.12	8 000	10 000	0.301	-	-
	72	17	1.1	0.6	-	64	NF207ETNG	50.3	50.2	6.12	8 000	10 000	0.301	-	-
	72	17	1.1	0.6	44	-	NU207EM1	47.5	46.6	5.68	8 000	10 000	0.301	HJ207	0.034
	72	17	1.1	0.6	44	-	NJ207EM1	47.5	46.6	5.68	8 000	10 000	0.301	HJ207	0.034
	72	17	1.1	0.6	44	-	NUP207EM1	47.5	46.6	5.68	8 000	10 000	0.301	-	-
	72	17	1.1	0.6	-	64	N207EM1	47.5	46.6	5.68	8 000	10 000	0.301	-	-

Single Row Cylindrical Roller Bearings

d = 35 mm

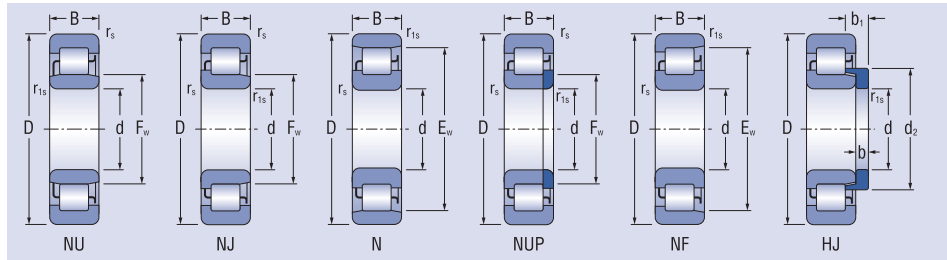

Dimensions							Bearing designation	Basic load rating		Fatigue load limit	Limiting speed for lubrication with		Mass of Bearings	Separate Thrust Collar	Mass of separate Thrust Collar
d	D	B	r _s min	r _{s1} min	F _w	E _w		C _r	C _{0r}		grease	oil			
mm							kN			min ⁻¹					
35	72	17	1.1	0.6	-	64	NF207EM1	47.5	46.6	5.68	8 000	10 000	0.301	-	-
	72	23	1.1	0.6	44	-	NU2207E	51.5	51.3	6.25	8 000	10 000	0.416	HJ2207	0.035
	72	23	1.1	0.6	44	-	NJ2207E	51.5	51.3	6.25	8 000	10 000	0.416	HJ2207	0.035
	72	23	1.1	0.6	44	-	NUP2207E	51.5	51.3	6.25	8 000	10 000	0.416	-	-
	72	23	1.1	0.6	-	64	N2207E	54.9	55.9	6.81	8 000	10 000	0.416	-	-
	72	23	1.1	0.6	-	64	NF2207E	51.5	51.3	6.25	8 000	10 000	0.416	-	-
	72	23	1.1	0.6	44	-	NU2207ETNG	61.6	65.3	7.96	8 000	10 000	0.416	HJ2207	0.035
	72	23	1.1	0.6	44	-	NJ2207ETNG	61.6	65.3	7.96	8 000	10 000	0.416	HJ2207	0.035
	72	23	1.1	0.6	44	-	NUP2207ETNG	61.6	65.3	7.96	8 000	10 000	0.416	-	-
	72	23	1.1	0.6	-	64	N2207ETNG	61.6	65.3	7.96	8 000	10 000	0.416	-	-
	72	23	1.1	0.6	-	64	NF2207ETNG	61.6	65.3	7.96	8 000	10 000	0.416	-	-
	72	23	1.1	0.6	44	-	NU2207EM1	58.3	60.6	7.39	8 000	10 000	0.416	HJ2207	0.035
	72	23	1.1	0.6	44	-	NJ2207EM1	58.3	60.6	7.39	8 000	10 000	0.416	HJ2207	0.035
	72	23	1.1	0.6	44	-	NUP2207EM1	58.3	60.6	7.39	8 000	10 000	0.416	-	-
	72	23	1.1	0.6	-	64	N2207EM1	58.3	60.6	7.39	8 000	10 000	0.416	-	-
	72	23	1.1	0.6	-	64	NF2207EM1	58.3	60.6	7.39	8 000	10 000	0.416	-	-
	80	21	1.5	1.1	46.2	-	NU307E	62.4	60.0	7.31	7 500	9 200	0.486	HJ307	0.060
	80	21	1.5	1.1	46.2	-	NJ307E	62.4	60.0	7.31	7 500	9 200	0.486	HJ307	0.060
	80	21	1.5	1.1	46.2	-	NUP307E	62.4	60.0	7.31	7 500	9 200	0.486	-	-
	80	21	1.5	1.1	-	70.2	N307E	62.4	60.0	7.31	7 500	9 200	0.486	-	-
	80	21	1.5	1.1	-	70.2	NF307E	62.4	60.0	7.31	7 500	9 200	0.486	-	-
	80	21	1.5	1.1	46.2	-	NU307ETNG	66.6	65.4	7.97	7 500	9 200	0.486	HJ307	0.060
	80	21	1.5	1.1	46.2	-	NJ307ETNG	66.6	65.4	7.97	7 500	9 200	0.486	HJ307	0.060
	80	21	1.5	1.1	46.2	-	NUP307ETNG	66.6	65.4	7.97	7 500	9 200	0.486	-	-
	80	21	1.5	1.1	-	70.2	N307ETNG	66.6	65.4	7.97	7 500	9 200	0.486	-	-
	80	21	1.5	1.1	-	70.2	NF307ETNG	66.6	65.4	7.97	7 500	9 200	0.486	-	-
	80	21	1.5	1.1	46.2	-	NU307EM	62.4	60.0	7.31	7 500	9 200	0.486	HJ307	0.060
	80	21	1.5	1.1	46.2	-	NJ307EM	62.4	60.0	7.31	7 500	9 200	0.486	HJ307	0.060
	80	21	1.5	1.1	46.2	-	NUP307EM	62.4	60.0	7.31	7 500	9 200	0.486	-	-
	80	21	1.5	1.1	-	70.2	N307EM	62.4	60.0	7.31	7 500	9 200	0.486	-	-
	80	21	1.5	1.1	-	70.2	NF307EM	62.4	60.0	7.31	7 500	9 200	0.486	-	-
	80	21	1.5	1.1	46.2	-	NU307EM1	66.6	65.4	7.97	7 500	9 200	0.486	HJ307	0.060
	80	21	1.5	1.1	46.2	-	NJ307EM1	66.6	65.4	7.97	7 500	9 200	0.486	HJ307	0.060
	80	21	1.5	1.1	46.2	-	NUP307EM1	66.6	65.4	7.97	7 500	9 200	0.486	-	-
	80	21	1.5	1.1	-	70.2	N307EM1	66.6	65.4	7.97	7 500	9 200	0.486	-	-
	80	21	1.5	1.1	-	70.2	NF307EM1	66.6	65.4	7.97	7 500	9 200	0.486	-	-
	80	31	1.5	1.1	46.2	-	NU2307E	75.1	75.4	9.20	7 500	9 200	0.736	HJ2307	0.064
	80	31	1.5	1.1	46.2	-	NJ2307E	75.1	75.4	9.20	7 500	9 200	0.736	HJ2307	0.064
	80	31	1.5	1.1	46.2	-	NUP2307E	75.1	75.4	9.20	7 500	9 200	0.736	-	-
	80	31	1.5	1.1	-	70.2	N2307E	75.1	75.4	9.20	7 500	9 200	0.736	-	-
	80	31	1.5	1.1	-	70.2	NF2307E	75.1	75.4	9.20	7 500	9 200	0.736	-	-
	80	31	1.5	1.1	46.2	-	NU2307ETNG	93.2	100.6	12.27	7 500	9 200	0.736	HJ2307	0.064

Single Row Cylindrical Roller Bearings

d = 35 - 40 mm

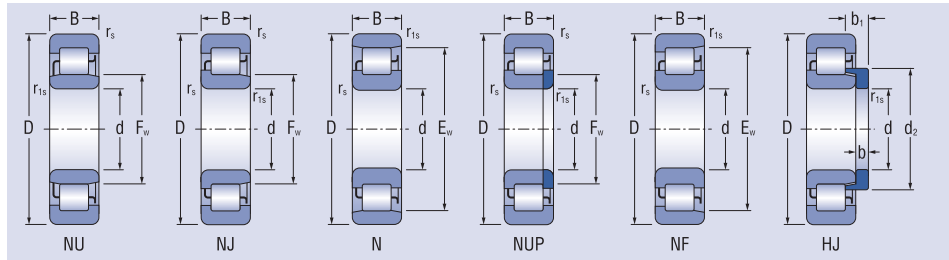

Dimensions							Bearing designation	Basic load rating		Fatigue load limit	Limiting speed		Mass of Bearings	Separate Thrust Collar	Mass of separate Thrust Collar
d	D	B	r _s min	r _{s1} min	F _w	E _w		C _r	C _{0r}		grease	oil			
mm							kN			min ⁻¹					
35	80	31	1.5	1.1	46.2	-	NJ2307ETNG	93.2	100.6	12.27	7 500	9 200	0.736	HJ2307	0.064
	80	31	1.5	1.1	46.2	-	NUP2307ETNG	93.2	100.6	12.27	7 500	9 200	0.736	-	-
	80	31	1.5	1.1	-	70.2	N2307ETNG	93.2	100.6	12.27	7 500	9 200	0.736	-	-
	80	31	1.5	1.1	-	70.2	NF2307ETNG	93.2	100.6	12.27	7 500	9 200	0.736	-	-
	80	31	1.5	1.1	46.2	-	NU2307EM	87.3	92.2	11.24	7 500	9 200	0.736	HJ2307	0.064
	80	31	1.5	1.1	46.2	-	NJ2307EM	87.3	92.2	11.24	7 500	9 200	0.736	HJ2307	0.064
	80	31	1.5	1.1	46.2	-	NUP2307EM	87.3	92.2	11.24	7 500	9 200	0.736	-	-
	80	31	1.5	1.1	-	70.2	N2307EM	87.3	92.2	11.24	7 500	9 200	0.736	-	-
	80	31	1.5	1.1	-	70.2	NF2307EM	87.3	92.2	11.24	7 500	9 200	0.736	-	-
	80	31	1.5	1.1	46.2	-	NU2307EM1	93.2	100.6	12.27	7 500	9 200	0.736	HJ2307	0.064
	80	31	1.5	1.1	46.2	-	NJ2307EM1	93.2	100.6	12.27	7 500	9 200	0.736	HJ2307	0.064
	80	31	1.5	1.1	46.2	-	NUP2307EM1	93.2	100.6	12.27	7 500	9 200	0.736	-	-
	80	31	1.5	1.1	-	70.2	N2307EM1	93.2	100.6	12.27	7 500	9 200	0.736	-	-
	80	31	1.5	1.1	-	70.2	NF2307EM1	93.2	100.6	12.27	7 500	9 200	0.736	-	-
	100	25	1.5	1.5	53	-	NU407EM	77.0	71.0	8.66	6 400	7 500	1.137	HJ407	0.130
	100	25	1.5	1.5	53	-	NJ407EM	77.0	71.0	8.66	6 400	7 500	1.137	HJ407	0.130
100	25	1.5	1.5	53	-	NUP407EM	77.0	71.0	8.66	6 400	7 500	1.137	-	-	
100	25	1.5	1.5	-	83	N407EM	77.0	71.0	8.66	6 400	7 500	1.137	-	-	
100	25	1.5	1.5	-	83	NF407EM	77.0	71.0	8.66	6 400	7 500	1.137	-	-	
40	68	15	1.0	0.6	47	-	NU1008EM	29.0	32.0	3.90	9 400	11 000	0.230	-	-
	68	15	1.0	0.6	47	-	NJ1008EM	29.0	32.0	3.90	9 400	11 000	0.230	-	-
	68	15	1.0	0.6	47	-	NUP1008EM	29.0	32.0	3.90	9 400	11 000	0.230	-	-
	80	18	1.1	1.1	49.5	-	NU208E	49.6	47.5	5.80	7 200	8 800	0.358	HJ208	0.050
	80	18	1.1	1.1	49.5	-	NJ208E	49.6	47.5	5.80	7 200	8 800	0.358	HJ208	0.050
	80	18	1.1	1.1	49.5	-	NUP208E	49.6	47.5	5.80	7 200	8 800	0.358	-	-
	80	18	1.1	1.1	-	71.5	N208E	49.6	47.5	5.80	7 200	8 800	0.358	-	-
	80	18	1.1	1.1	-	71.5	NF208E	49.6	47.5	5.80	7 200	8 800	0.358	-	-
	80	18	1.1	1.1	49.5	-	NU208ETNG	55.7	55.4	6.75	7 200	8 800	0.358	HJ208	0.050
	80	18	1.1	1.1	49.5	-	NJ208ETNG	55.7	55.4	6.75	7 200	8 800	0.358	HJ208	0.050
	80	18	1.1	1.1	49.5	-	NUP208ETNG	55.7	55.4	6.75	7 200	8 800	0.358	-	-
	80	18	1.1	1.1	-	71.5	N208ETNG	55.7	55.4	6.75	7 200	8 800	0.358	-	-
	80	18	1.1	1.1	-	71.5	NF208ETNG	55.7	55.4	6.75	7 200	8 800	0.358	-	-
	80	18	1.1	1.1	49.5	-	NU208EM1	55.7	55.4	6.75	7 200	8 800	0.358	HJ208	0.050
	80	18	1.1	1.1	49.5	-	NJ208EM1	55.7	55.4	6.75	7 200	8 800	0.358	HJ208	0.050
	80	18	1.1	1.1	49.5	-	NUP208EM1	55.7	55.4	6.75	7 200	8 800	0.358	-	-
	80	18	1.1	1.1	-	71.5	N208EM1	55.7	55.4	6.75	7 200	8 800	0.358	-	-
	80	18	1.1	1.1	-	71.5	NF208EM1	55.7	55.4	6.75	7 200	8 800	0.358	-	-
	80	23	1.1	1.1	49.5	-	NU2208E	60.4	61.0	7.44	7 200	8 800	0.504	HJ2208	0.051
	80	23	1.1	1.1	49.5	-	NJ2208E	60.4	61.0	7.44	7 200	8 800	0.504	HJ2208	0.051
	80	23	1.1	1.1	49.5	-	NUP2208E	60.4	61.0	7.44	7 200	8 800	0.504	-	-
	80	23	1.1	1.1	-	71.5	N2208E	64.4	66.5	8.11	7 200	8 800	0.504	-	-
	80	23	1.1	1.1	-	71.5	NF2208E	60.4	61.0	7.44	7 200	8 800	0.504	-	-

Single Row Cylindrical Roller Bearings

d = 40 mm

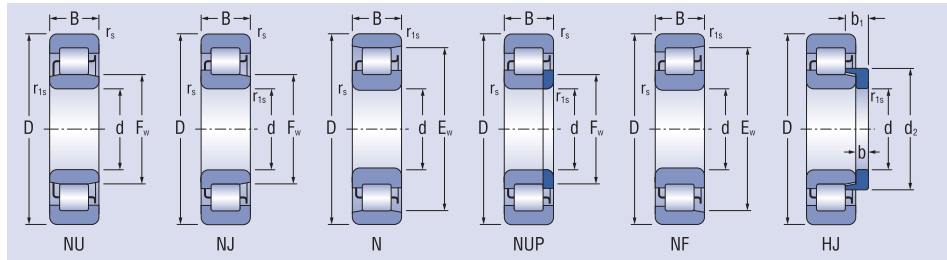

Dimensions							Bearing designation	Basic load rating		Fatigue load limit	Limiting speed for lubrication with		Mass of Bearings	Separate Thrust Collar	Mass of separate Thrust Collar
d	D	B	r _s min	r _{s1} min	F _w	E _w		C _r	C _{0r}		grease	oil			
mm							kN			min ⁻¹					
40	80	23	1.1	1.1	49.5	-	NU2208ETNG	72.3	77.6	9.47	7 200	8 800	0.504	HJ2208	0.051
	80	23	1.1	1.1	49.5	-	NJ2208ETNG	72.3	77.6	9.47	7 200	8 800	0.504	HJ2208	0.051
	80	23	1.1	1.1	49.5	-	NUP2208ETNG	72.3	77.6	9.47	7 200	8 800	0.504	-	-
	80	23	1.1	1.1	-	71.5	N2208ETNG	72.3	77.6	9.47	7 200	8 800	0.504	-	-
	80	23	1.1	1.1	-	71.5	NF2208ETNG	72.3	77.6	9.47	7 200	8 800	0.504	-	-
	80	23	1.1	1.1	49.5	-	NU2208EM	64.4	66.5	8.11	7 200	8 800	0.504	HJ2208	0.051
	80	23	1.1	1.1	49.5	-	NJ2208EM	64.4	66.5	8.11	7 200	8 800	0.504	HJ2208	0.051
	80	23	1.1	1.1	49.5	-	NUP2208EM	64.4	66.5	8.11	7 200	8 800	0.504	-	-
	80	23	1.1	1.1	-	71.5	N2208EM	64.4	66.5	8.11	7 200	8 800	0.504	-	-
	80	23	1.1	1.1	-	71.5	NF2208EM	64.4	66.5	8.11	7 200	8 800	0.504	-	-
	80	23	1.1	1.1	49.5	-	NU2208EM1	72.3	77.6	9.47	7 200	8 800	0.504	HJ2208	0.051
	80	23	1.1	1.1	49.5	-	NJ2208EM1	72.3	77.6	9.47	7 200	8 800	0.504	HJ2208	0.051
	80	23	1.1	1.1	49.5	-	NUP2208EM1	72.3	77.6	9.47	7 200	8 800	0.504	-	-
	80	23	1.1	1.1	-	71.5	N2208EM1	72.3	77.6	9.47	7 200	8 800	0.504	-	-
	80	23	1.1	1.1	-	71.5	NF2208EM1	72.3	77.6	9.47	7 200	8 800	0.504	-	-
	90	23	1.5	1.5	52	-	NU308E	71.8	67.0	8.17	6 600	8 200	0.656	HJ308	0.088
	90	23	1.5	1.5	52	-	NJ308E	71.8	67.0	8.17	6 600	8 200	0.656	HJ308	0.088
	90	23	1.5	1.5	52	-	NUP308E	71.8	67.0	8.17	6 600	8 200	0.656	-	-
	90	23	1.5	1.5	-	80	N308E	77.0	73.7	8.98	6 600	8 200	0.656	-	-
	90	23	1.5	1.5	-	80	NF308E	71.8	67.0	8.17	6 600	8 200	0.656	-	-
	90	23	1.5	1.5	52	-	NU308ETNG	82.3	80.4	9.80	6 600	8 200	0.656	HJ308	0.088
	90	23	1.5	1.5	52	-	NJ308ETNG	82.3	80.4	9.80	6 600	8 200	0.656	HJ308	0.088
	90	23	1.5	1.5	52	-	NUP308ETNG	82.3	80.4	9.80	6 600	8 200	0.656	-	-
	90	23	1.5	1.5	-	80	N308ETNG	82.3	80.4	9.80	6 600	8 200	0.656	-	-
	90	23	1.5	1.5	-	80	NF308ETNG	82.3	80.4	9.80	6 600	8 200	0.656	-	-
	90	23	1.5	1.5	52	-	NU308EM	77.0	73.7	8.98	6 600	8 200	0.656	HJ308	0.088
	90	23	1.5	1.5	52	-	NJ308EM	77.0	73.7	8.98	6 600	8 200	0.656	HJ308	0.088
	90	23	1.5	1.5	52	-	NUP308EM	77.0	73.7	8.98	6 600	8 200	0.656	-	-
	90	23	1.5	1.5	-	80	N308EM	77.0	73.7	8.98	6 600	8 200	0.656	-	-
	90	23	1.5	1.5	-	80	NF308EM	77.0	73.7	8.98	6 600	8 200	0.656	-	-
	90	23	1.5	1.5	52	-	NU308EM1	82.3	80.4	9.80	6 600	8 200	0.656	HJ308	0.088
	90	23	1.5	1.5	52	-	NJ308EM1	82.3	80.4	9.80	6 600	8 200	0.656	HJ308	0.088
	90	23	1.5	1.5	52	-	NUP308EM1	82.3	80.4	9.80	6 600	8 200	0.656	-	-
	90	23	1.5	1.5	-	80	N308EM1	82.3	80.4	9.80	6 600	8 200	0.656	-	-
	90	23	1.5	1.5	-	80	NF308EM1	82.3	80.4	9.80	6 600	8 200	0.656	-	-
	90	33	1.5	1.5	52	-	NU2308E	98.8	101.0	12.31	7 000	8 400	0.978	HJ2308	0.093
	90	33	1.5	1.5	52	-	NJ2308E	98.8	101.0	12.31	7 000	8 400	0.978	HJ2308	0.093
	90	33	1.5	1.5	52	-	NUP2308E	98.8	101.0	12.31	7 000	8 400	0.978	-	-
	90	33	1.5	1.5	-	80	N2308E	98.8	101.0	12.31	7 000	8 400	0.978	-	-
	90	33	1.5	1.5	-	80	NF2308E	98.8	101.0	12.31	7 000	8 400	0.978	-	-
	90	33	1.5	1.5	52	-	NU2308ETNG	113.2	121.1	14.77	7 000	8 400	0.978	HJ2308	0.093
	90	33	1.5	1.5	52	-	NJ2308ETNG	113.2	121.1	14.77	7 000	8 400	0.978	HJ2308	0.093

Single Row Cylindrical Roller Bearings

d = 40 - 45 mm

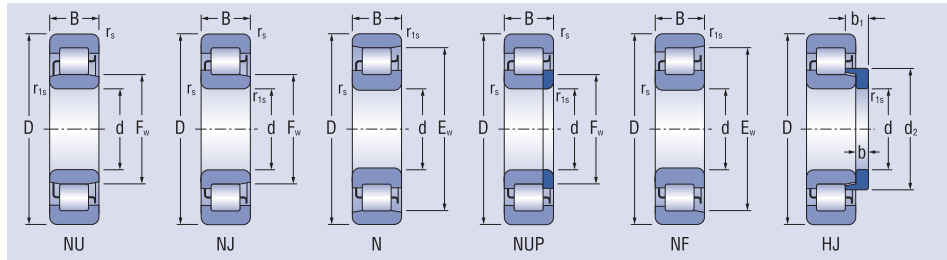

Dimensions							Bearing designation	Basic load rating		Fatigue load limit	Limiting speed for lubrication with		Mass of Bearings	Separate Thrust Collar	Mass of separate Thrust Collar	
d	D	B	r _s min	r _{s1} min	F _w	E _w		C _r	C _{0r}		grease	oil				kg
mm							kN			min ⁻¹						
40	90	33	1.5	1.5	52	-	NUP2308ETNG	113.2	121.1	14.77		7 000	8 400	0.978	-	-
	90	33	1.5	1.5	-	80	N2308ETNG	113.2	121.1	14.77		7 000	8 400	0.978	-	-
	90	33	1.5	1.5	-	80	NF2308ETNG	113.2	121.1	14.77		7 000	8 400	0.978	-	-
	90	33	1.5	1.5	52	-	NU2308EM	102.7	110.0	13.41		7 000	8 400	0.978	HJ2308	0.093
	90	33	1.5	1.5	52	-	NJ2308EM	102.7	110.0	13.41		7 000	8 400	0.978	HJ2308	0.093
	90	33	1.5	1.5	52	-	NUP2308EM	102.7	110.0	13.41		7 000	8 400	0.978	-	-
	90	33	1.5	1.5	-	80	N2308EM	102.7	110.0	13.41		7 000	8 400	0.978	-	-
	90	33	1.5	1.5	-	80	NF2308EM	102.7	110.0	13.41		7 000	8 400	0.978	-	-
	90	33	1.5	1.5	52	-	NU2308EM1	113.2	121.1	14.77		7 000	8 400	0.978	HJ2308	0.093
	90	33	1.5	1.5	52	-	NJ2308EM1	113.2	121.1	14.77		7 000	8 400	0.978	HJ2308	0.093
	90	33	1.5	1.5	52	-	NUP2308EM1	113.2	121.1	14.77		7 000	8 400	0.978	-	-
	90	33	1.5	1.5	-	80	N2308EM1	113.2	121.1	14.77		7 000	8 400	0.978	-	-
	90	33	1.5	1.5	-	80	NF2308EM1	113.2	121.1	14.77		7 000	8 400	0.978	-	-
	110	27	2.1	2.1	58	-	NU408EM	103.9	99.3	12.10		5 700	6 700	1.312	HJ408	0.140
110	27	2.1	2.1	58	-	NJ408EM	103.9	99.3	12.10		5 700	6 700	1.312	HJ408	0.140	
110	27	2.1	2.1	58	-	NUP408EM	103.9	99.3	12.10		5 700	6 700	1.312	-	-	
110	27	2.1	2.1	-	92	N408EM	103.9	99.3	12.10		5 700	6 700	1.312	-	-	
110	27	2.1	2.1	-	92	NF408EM	103.9	99.3	12.10		5 700	6 700	1.312	-	-	
45	75	16	1.0	0.6	52.5	-	NU1009EM	34.5	39.0	4.75		8 500	10 000	0.260	-	-
	75	16	1.0	0.6	52.5	-	NJ1009EM	34.5	39.0	4.75		8 500	10 000	0.260	-	-
	75	16	1.0	0.6	52.5	-	NUP1009EM	34.5	39.0	4.75		8 500	10 000	0.260	-	-
	85	19	1.1	1.1	54.5	-	NU209E	56.6	57.6	7.02		6 600	8 200	0.434	HJ209	0.055
	85	19	1.1	1.1	54.5	-	NJ209E	56.6	57.6	7.02		6 600	8 200	0.434	HJ209	0.055
	85	19	1.1	1.1	54.5	-	NUP209E	56.6	57.6	7.02		6 600	8 200	0.434	-	-
	85	19	1.1	1.1	-	76.5	N209E	56.6	57.6	7.02		6 600	8 200	0.434	-	-
	85	19	1.1	1.1	-	76.5	NF209E	56.6	57.6	7.02		6 600	8 200	0.434	-	-
	85	19	1.1	1.1	54.5	-	NU209ETNG	63.1	66.5	8.11		6 600	8 200	0.434	HJ209	0.055
	85	19	1.1	1.1	54.5	-	NJ209ETNG	63.1	66.5	8.11		6 600	8 200	0.434	HJ209	0.055
	85	19	1.1	1.1	54.5	-	NUP209ETNG	63.1	66.5	8.11		6 600	8 200	0.434	-	-
	85	19	1.1	1.1	-	76.5	N209ETNG	63.1	66.5	8.11		6 600	8 200	0.434	-	-
	85	19	1.1	1.1	-	76.5	NF209ETNG	63.1	66.5	8.11		6 600	8 200	0.434	-	-
	85	19	1.1	1.1	54.5	-	NU209EM	56.6	57.6	7.02		6 600	8 200	0.434	HJ209	0.055
	85	19	1.1	1.1	54.5	-	NJ209EM	56.6	57.6	7.02		6 600	8 200	0.434	HJ209	0.055
	85	19	1.1	1.1	54.5	-	NUP209EM	56.6	57.6	7.02		6 600	8 200	0.434	-	-
	85	19	1.1	1.1	-	76.5	N209EM	56.6	57.6	7.02		6 600	8 200	0.434	-	-
	85	19	1.1	1.1	-	76.5	NF209EM	56.6	57.6	7.02		6 600	8 200	0.434	-	-
	85	19	1.1	1.1	54.5	-	NU209EM1	63.1	66.5	8.11		6 600	8 200	0.434	HJ209	0.055
	85	19	1.1	1.1	54.5	-	NJ209EM1	63.1	66.5	8.11		6 600	8 200	0.434	HJ209	0.055
	85	19	1.1	1.1	54.5	-	NUP209EM1	63.1	66.5	8.11		6 600	8 200	0.434	-	-
	85	19	1.1	1.1	-	76.5	N209EM1	63.1	66.5	8.11		6 600	8 200	0.434	-	-
	85	19	1.1	1.1	-	76.5	NF209EM1	63.1	66.5	8.11		6 600	8 200	0.434	-	-
	85	23	1.1	1.1	54.5	-	NU2209E	68.4	73.3	8.94		6 600	8 200	0.544	HJ2209	0.055

Single Row Cylindrical Roller Bearings

d = 45 mm

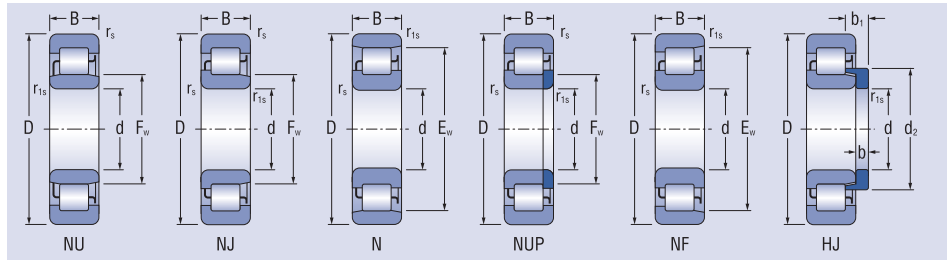

Dimensions							Bearing designation	Basic load rating		Fatigue load limit	Limiting speed for lubrication with		Mass of Bearings	Separate Thrust Collar	Mass of separate Thrust Collar
d	D	B	r _s min	r _{s1} min	F _w	E _w		C _r	C _{0r}		grease	oil			
mm							kN			min ⁻¹					
45	85	23	1.1	1.1	54.5	-	NJ2209E	68.4	73.3	8.94	6 600	8 200	0.544	HJ2209	0.055
	85	23	1.1	1.1	54.5	-	NUP2209E	68.4	73.3	8.94	6 600	8 200	0.544	-	-
	85	23	1.1	1.1	-	76.5	N2209E	68.4	73.3	8.94	6 600	8 200	0.544	-	-
	85	23	1.1	1.1	-	76.5	NF2209E	68.4	73.3	8.94	6 600	8 200	0.544	-	-
	85	23	1.1	1.1	54.5	-	NU2209ETNG	76.0	84.6	10.31	6 600	8 200	0.544	HJ2209	0.055
	85	23	1.1	1.1	54.5	-	NJ2209ETNG	76.0	84.6	10.31	6 600	8 200	0.544	HJ2209	0.055
	85	23	1.1	1.1	54.5	-	NUP2209ETNG	76.0	84.6	10.31	6 600	8 200	0.544	-	-
	85	23	1.1	1.1	-	76.5	N2209ETNG	76.0	84.6	10.31	6 600	8 200	0.544	-	-
	85	23	1.1	1.1	-	76.5	NF2209ETNG	76.0	84.6	10.31	6 600	8 200	0.544	-	-
	85	23	1.1	1.1	54.5	-	NU2209EM1	76.0	84.6	10.31	6 600	8 200	0.544	HJ2209	0.055
	85	23	1.1	1.1	54.5	-	NJ2209EM1	76.0	84.6	10.31	6 600	8 200	0.544	HJ2209	0.055
	85	23	1.1	1.1	54.5	-	NUP2209EM1	76.0	84.6	10.31	6 600	8 200	0.544	-	-
	85	23	1.1	1.1	-	76.5	N2209EM1	76.0	84.6	10.31	6 600	8 200	0.544	-	-
	85	23	1.1	1.1	-	76.5	NF2209EM1	76.0	84.6	10.31	6 600	8 200	0.544	-	-
	100	25	1.5	1.5	58.5	-	NU309E	87.9	85.5	10.43	5 900	7 300	0.891	HJ309	0.110
	100	25	1.5	1.5	58.5	-	NJ309E	87.9	85.5	10.43	5 900	7 300	0.891	HJ309	0.110
	100	25	1.5	1.5	58.5	-	NUP309E	87.9	85.5	10.43	5 900	7 300	0.891	-	-
	100	25	1.5	1.5	-	88.5	N309E	93.7	93.3	11.38	5 900	7 300	0.891	-	-
	100	25	1.5	1.5	-	88.5	NF309E	87.9	85.5	10.43	5 900	7 300	0.891	-	-
	100	25	1.5	1.5	58.5	-	NU309ETNG	99.6	101.1	12.33	5 900	7 300	0.891	HJ309	0.110
	100	25	1.5	1.5	58.5	-	NJ309ETNG	99.6	101.1	12.33	5 900	7 300	0.891	HJ309	0.110
	100	25	1.5	1.5	58.5	-	NUP309ETNG	99.6	101.1	12.33	5 900	7 300	0.891	-	-
	100	25	1.5	1.5	-	88.5	N309ETNG	99.6	101.1	12.33	5 900	7 300	0.891	-	-
	100	25	1.5	1.5	-	88.5	NF309ETNG	99.6	101.1	12.33	5 900	7 300	0.891	-	-
	100	25	1.5	1.5	58.5	-	NU309EM	87.9	85.5	10.43	5 900	7 300	0.891	HJ309	0.110
	100	25	1.5	1.5	58.5	-	NJ309EM	87.9	85.5	10.43	5 900	7 300	0.891	HJ309	0.110
	100	25	1.5	1.5	58.5	-	NUP309EM	87.9	85.5	10.43	5 900	7 300	0.891	-	-
	100	25	1.5	1.5	-	88.5	N309EM	87.9	85.5	10.43	5 900	7 300	0.891	-	-
	100	25	1.5	1.5	-	88.5	NF309EM	87.9	85.5	10.43	5 900	7 300	0.891	-	-
	100	25	1.5	1.5	58.5	-	NU309EM1	93.7	93.3	11.38	5 900	7 300	0.891	HJ309	0.110
	100	25	1.5	1.5	58.5	-	NJ309EM1	93.7	93.3	11.38	5 900	7 300	0.891	HJ309	0.110
	100	25	1.5	1.5	58.5	-	NUP309EM1	93.7	93.3	11.38	5 900	7 300	0.891	-	-
	100	25	1.5	1.5	-	88.5	N309EM1	93.7	93.3	11.38	5 900	7 300	0.891	-	-
	100	25	1.5	1.5	-	88.5	NF309EM1	93.7	93.3	11.38	5 900	7 300	0.891	-	-
	100	36	1.5	1.5	58.5	-	NU2309E	122.8	131.8	16.07	5 900	7 300	1.331	HJ2309	0.116
	100	36	1.5	1.5	58.5	-	NJ2309E	122.8	131.8	16.07	5 900	7 300	1.331	HJ2309	0.116
	100	36	1.5	1.5	58.5	-	NUP2309E	122.8	131.8	16.07	5 900	7 300	1.331	-	-
	100	36	1.5	1.5	-	88.5	N2309E	122.8	131.8	16.07	5 900	7 300	1.331	-	-
	100	36	1.5	1.5	-	88.5	NF2309E	122.8	131.8	16.07	5 900	7 300	1.331	-	-
	100	36	1.5	1.5	58.5	-	NU2309ETNG	139.2	155.7	18.99	5 900	7 300	1.331	HJ2309	0.116
	100	36	1.5	1.5	58.5	-	NJ2309ETNG	139.2	155.7	18.99	5 900	7 300	1.331	HJ2309	0.116
	100	36	1.5	1.5	58.5	-	NUP2309ETNG	139.2	155.7	18.99	5 900	7 300	1.331	-	-

Single Row Cylindrical Roller Bearings

d = 45 - 50 mm

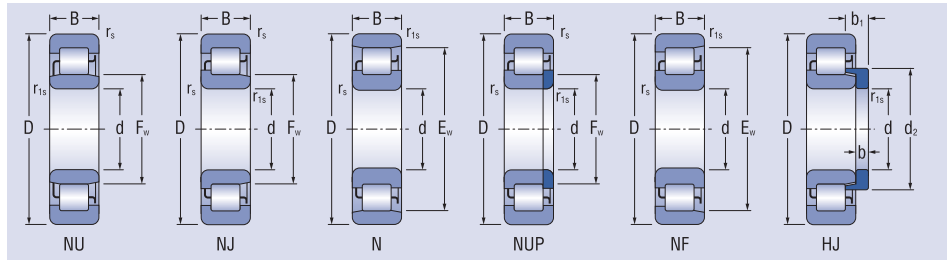

Dimensions								Bearing designation	Basic load rating		Fatigue load limit	Limiting speed for lubrication with		Mass of Bearings	Separate Thrust Collar	Mass of separate Thrust Collar
d	D	B	rs min	rs1 min	Fw	Ew	Cr		C0r	Cu		grease	oil			
mm	mm	mm	mm	mm	mm	mm	kN	kN	kN	min ⁻¹	min ⁻¹	kg	kg	kg		
45	100	36	1.5	1.5	-	88.5	N2309ETNG	139.2	155.7	18.99	5 900	7 300	1.331	-	-	
	100	36	1.5	1.5	-	88.5	NF2309ETNG	139.2	155.7	18.99	5 900	7 300	1.331	-	-	
	100	36	1.5	1.5	58.5	-	NU2309EM	122.8	131.8	16.07	5 900	7 300	1.331	HJ2309	0.116	
	100	36	1.5	1.5	58.5	-	NJ2309EM	122.8	131.8	16.07	5 900	7 300	1.331	HJ2309	0.116	
	100	36	1.5	1.5	58.5	-	NUP2309EM	122.8	131.8	16.07	5 900	7 300	1.331	-	-	
	100	36	1.5	1.5	-	88.5	N2309EM	122.8	131.8	16.07	5 900	7 300	1.331	-	-	
	100	36	1.5	1.5	-	88.5	NF2309EM	122.8	131.8	16.07	5 900	7 300	1.331	-	-	
	100	36	1.5	1.5	58.5	-	NU2309EM1	131.1	143.7	17.53	5 900	7 300	1.331	HJ2309	0.116	
	100	36	1.5	1.5	58.5	-	NJ2309EM1	131.1	143.7	17.53	5 900	7 300	1.331	HJ2309	0.116	
	100	36	1.5	1.5	58.5	-	NUP2309EM1	131.1	143.7	17.53	5 900	7 300	1.331	-	-	
	100	36	1.5	1.5	-	88.5	N2309EM1	131.1	143.7	17.53	5 900	7 300	1.331	-	-	
	100	36	1.5	1.5	-	88.5	NF2309EM1	131.1	143.7	17.53	5 900	7 300	1.331	-	-	
	120	29	2.1	2.1	64.5	-	-	NU409EM	116.3	113.1	13.79	5 100	6 000	1.869	HJ409	0.180
	120	29	2.1	2.1	64.5	-	-	NJ409EM	116.3	113.1	13.79	5 100	6 000	1.869	HJ409	0.180
	120	29	2.1	2.1	64.5	-	-	NUP409EM	116.3	113.1	13.79	5 100	6 000	1.869	-	-
	120	29	2.1	2.1	-	100.5	-	N409EM	116.3	113.1	13.79	5 100	6 000	1.869	-	-
120	29	2.1	2.1	-	100.5	-	NF409EM	116.3	113.1	13.79	5 100	6 000	1.869	-	-	
50	80	16	1.0	0.6	57.5	-	NU1010EM	36.0	41.5	5.06	7 900	9 400	0.286	-	-	
	80	16	1.0	0.6	57.5	-	NJ1010EM	36.0	41.5	5.06	7 900	9 400	0.286	-	-	
	80	16	1.0	0.6	57.5	-	NUP1010EM	36.0	41.5	5.06	7 900	9 400	0.286	-	-	
	90	20	1.1	1.1	59.5	-	NU210E	59.7	62.9	7.67	6 100	7 600	0.488	HJ210	0.061	
	90	20	1.1	1.1	59.5	-	NJ210E	59.7	62.9	7.67	6 100	7 600	0.488	HJ210	0.061	
	90	20	1.1	1.1	59.5	-	NUP210E	59.7	62.9	7.67	6 100	7 600	0.488	-	-	
	90	20	1.1	1.1	-	81.5	-	N210E	59.7	62.9	7.67	6 100	7 600	0.488	-	-
	90	20	1.1	1.1	-	81.5	-	NF210E	59.7	62.9	7.67	6 100	7 600	0.488	-	-
	90	20	1.1	1.1	59.5	-	-	NU210ETNG	66.0	71.9	8.77	6 100	7 600	0.488	HJ210	0.061
	90	20	1.1	1.1	59.5	-	-	NJ210ETNG	66.0	71.9	8.77	6 100	7 600	0.488	HJ210	0.061
	90	20	1.1	1.1	59.5	-	-	NUP210ETNG	66.0	71.9	8.77	6 100	7 600	0.488	-	-
	90	20	1.1	1.1	-	81.5	-	N210ETNG	66.0	71.9	8.77	6 100	7 600	0.488	-	-
	90	20	1.1	1.1	-	81.5	-	NF210ETNG	66.0	71.9	8.77	6 100	7 600	0.488	-	-
	90	20	1.1	1.1	59.5	-	-	NU210EM	59.7	62.9	7.67	6 100	7 600	0.488	HJ210	0.061
	90	20	1.1	1.1	59.5	-	-	NJ210EM	59.7	62.9	7.67	6 100	7 600	0.488	HJ210	0.061
	90	20	1.1	1.1	59.5	-	-	NUP210EM	59.7	62.9	7.67	6 100	7 600	0.488	-	-
	90	20	1.1	1.1	-	81.5	-	N210EM	59.7	62.9	7.67	6 100	7 600	0.488	-	-
	90	20	1.1	1.1	-	81.5	-	NF210EM	59.7	62.9	7.67	6 100	7 600	0.488	-	-
	90	20	1.1	1.1	59.5	-	-	NU210EM1	66.0	71.9	8.77	6 100	7 600	0.488	HJ210	0.061
	90	20	1.1	1.1	59.5	-	-	NJ210EM1	66.0	71.9	8.77	6 100	7 600	0.488	HJ210	0.061
	90	20	1.1	1.1	59.5	-	-	NUP210EM1	66.0	71.9	8.77	6 100	7 600	0.488	-	-
	90	20	1.1	1.1	-	81.5	-	N210EM1	66.0	71.9	8.77	6 100	7 600	0.488	-	-
	90	20	1.1	1.1	-	81.5	-	NF210EM1	66.0	71.9	8.77	6 100	7 600	0.488	-	-
	90	23	1.1	1.1	59.5	-	-	NU2210E	72.0	80.1	9.76	6 100	7 600	0.586	HJ2210	0.061
90	23	1.1	1.1	59.5	-	-	NJ2210E	72.0	80.1	9.76	6 100	7 600	0.586	HJ2210	0.061	

Single Row Cylindrical Roller Bearings

d = 50 mm

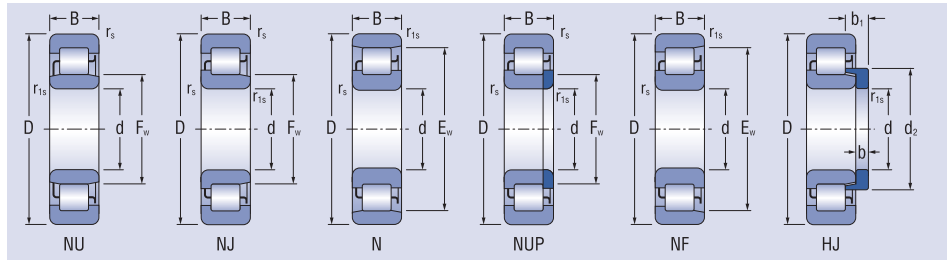

Dimensions							Bearing designation	Basic load rating		Fatigue load limit	Limiting speed for lubrication with		Mass of Bearings	Separate Thrust Collar	Mass of separate Thrust Collar
d	D	B	r _s min	r _{s1} min	F _w	E _w		C _r	C _{0r}		grease	oil			
mm							kN			min ⁻¹					
50	90	23	1.1	1.1	59.5	-	NUP2210E	72.0	80.1	9.76	6 100	7 600	0.586	-	-
	90	23	1.1	1.1	-	81.5	N2210E	72.0	80.1	9.76	6 100	7 600	0.586	-	-
	90	23	1.1	1.1	-	81.5	NF2210E	72.0	80.1	9.76	6 100	7 600	0.586	-	-
	90	23	1.1	1.1	59.5	-	NU2210ETNG	79.6	91.5	11.16	6 100	7 600	0.586	HJ2210	0.061
	90	23	1.1	1.1	59.5	-	NJ2210ETNG	79.6	91.5	11.16	6 100	7 600	0.586	HJ2210	0.061
	90	23	1.1	1.1	59.5	-	NUP2210ETNG	79.6	91.5	11.16	6 100	7 600	0.586	-	-
	90	23	1.1	1.1	-	81.5	N2210ETNG	79.6	91.5	11.16	6 100	7 600	0.586	-	-
	90	23	1.1	1.1	-	81.5	NF2210ETNG	79.6	91.5	11.16	6 100	7 600	0.586	-	-
	90	23	1.1	1.1	59.5	-	NU2210EM1	79.6	91.5	11.16	6 100	7 600	0.586	HJ2210	0.061
	90	23	1.1	1.1	59.5	-	NJ2210EM1	79.6	91.5	11.16	6 100	7 600	0.586	HJ2210	0.061
	90	23	1.1	1.1	59.5	-	NUP2210EM1	79.6	91.5	11.16	6 100	7 600	0.586	-	-
	90	23	1.1	1.1	-	81.5	N2210EM1	79.6	91.5	11.16	6 100	7 600	0.586	-	-
	90	23	1.1	1.1	-	81.5	NF2210EM1	79.6	91.5	11.16	6 100	7 600	0.586	-	-
	110	27	2.1	2.1	65	-	NU310E	99.1	98.2	11.97	5 400	6 600	1.160	HJ310	0.151
	110	27	2.1	2.1	65	-	NJ310E	99.1	98.2	11.97	5 400	6 600	1.160	HJ310	0.151
	110	27	2.1	2.1	65	-	NUP310E	99.1	98.2	11.97	5 400	6 600	1.160	-	-
	110	27	2.1	2.1	-	97	N310E	105.7	107.1	13.06	5 400	6 600	1.160	-	-
	110	27	2.1	2.1	-	97	NF310E	99.1	98.2	11.97	5 400	6 600	1.160	-	-
	110	27	2.1	2.1	65	-	NU310ETNG	112.3	116.0	14.15	5 400	6 600	1.160	HJ310	0.151
	110	27	2.1	2.1	65	-	NJ310ETNG	112.3	116.0	14.15	5 400	6 600	1.160	HJ310	0.151
	110	27	2.1	2.1	65	-	NUP310ETNG	112.3	116.0	14.15	5 400	6 600	1.160	-	-
	110	27	2.1	2.1	-	97	N310ETNG	112.3	116.0	14.15	5 400	6 600	1.160	-	-
	110	27	2.1	2.1	-	97	NF310ETNG	112.3	116.0	14.15	5 400	6 600	1.160	-	-
	110	27	2.1	2.1	65	-	NU310EM	105.7	107.1	13.06	5 400	6 600	1.160	HJ310	0.151
	110	27	2.1	2.1	65	-	NJ310EM	105.7	107.1	13.06	5 400	6 600	1.160	HJ310	0.151
	110	27	2.1	2.1	65	-	NUP310EM	105.7	107.1	13.06	5 400	6 600	1.160	-	-
	110	27	2.1	2.1	-	97	N310EM	105.7	107.1	13.06	5 400	6 600	1.160	-	-
	110	27	2.1	2.1	-	97	NF310EM	105.7	107.1	13.06	5 400	6 600	1.160	-	-
	110	27	2.1	2.1	65	-	NU310EM1	112.3	116.0	14.15	5 400	6 600	1.160	HJ310	0.151
	110	27	2.1	2.1	65	-	NJ310EM1	112.3	116.0	14.15	5 400	6 600	1.160	HJ310	0.151
	110	27	2.1	2.1	65	-	NUP310EM1	112.3	116.0	14.15	5 400	6 600	1.160	-	-
	110	27	2.1	2.1	-	97	N310EM1	112.3	116.0	14.15	5 400	6 600	1.160	-	-
	110	27	2.1	2.1	-	97	NF310EM1	112.3	116.0	14.15	5 400	6 600	1.160	-	-
	110	40	2.1	2.1	65	-	NU2310E	145.1	160.3	19.55	5 400	6 600	1.770	HJ2310	0.158
	110	40	2.1	2.1	65	-	NJ2310E	145.1	160.3	19.55	5 400	6 600	1.770	HJ2310	0.158
	110	40	2.1	2.1	65	-	NUP2310E	145.1	160.3	19.55	5 400	6 600	1.770	-	-
	110	40	2.1	2.1	-	97	N2310E	145.1	160.3	19.55	5 400	6 600	1.770	-	-
	110	40	2.1	2.1	-	97	NF2310E	145.1	160.3	19.55	5 400	6 600	1.770	-	-
	110	40	2.1	2.1	65	-	NU2310ETNG	164.6	189.5	23.11	5 400	6 600	1.770	HJ2310	0.158
	110	40	2.1	2.1	65	-	NJ2310ETNG	164.6	189.5	23.11	5 400	6 600	1.770	HJ2310	0.158
	110	40	2.1	2.1	65	-	NUP2310ETNG	164.6	189.5	23.11	5 400	6 600	1.770	-	-
	110	40	2.1	2.1	-	97	N2310ETNG	164.6	189.5	23.11	5 400	6 600	1.770	-	-

Single Row Cylindrical Roller Bearings

d = 50 - 55 mm

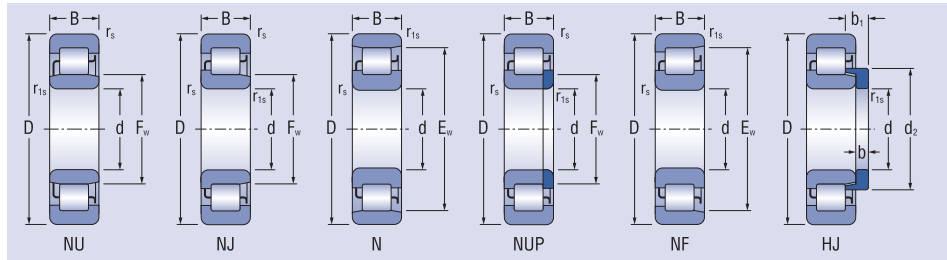

Dimensions							Bearing designation	Basic load rating		Fatigue load limit	Limiting speed		Mass of Bearings	Separate Thrust Collar	Mass of separate Thrust Collar	
d	D	B	r _s min	r _{s1} min	F _w	E _w		C _r	C _{0r}		grease	oil				kg
mm							kN			min ⁻¹						
50	110	40	2.1	2.1	-	97	NF2310ETNG	164.6	189.5	23.11	5 400	6 600	1.770	-	-	
	110	40	2.1	2.1	65	-	NU2310EM	154.9	174.9	21.33	5 400	6 600	1.770	HJ2310	0.158	
	110	40	2.1	2.1	65	-	NJ2310EM	154.9	174.9	21.33	5 400	6 600	1.770	HJ2310	0.158	
	110	40	2.1	2.1	65	-	NUP2310EM	154.9	174.9	21.33	5 400	6 600	1.770	-	-	
	110	40	2.1	2.1	-	97	N2310EM	154.9	174.9	21.33	5 400	6 600	1.770	-	-	
	110	40	2.1	2.1	-	97	NF2310EM	154.9	174.9	21.33	5 400	6 600	1.770	-	-	
	110	40	2.1	2.1	65	-	NU2310EM1	164.6	189.5	23.11	5 400	6 600	1.770	HJ2310	0.158	
	110	40	2.1	2.1	65	-	NJ2310EM1	164.6	189.5	23.11	5 400	6 600	1.770	HJ2310	0.158	
	110	40	2.1	2.1	65	-	NUP2310EM1	164.6	189.5	23.11	5 400	6 600	1.770	-	-	
	110	40	2.1	2.1	-	97	N2310EM1	164.6	189.5	23.11	5 400	6 600	1.770	-	-	
	110	40	2.1	2.1	-	97	NF2310EM1	164.6	189.5	23.11	5 400	6 600	1.770	-	-	
	130	31	2.1	2.1	70.8	-	-	NU410EM	142.1	140.4	17.12	4 700	5 600	2.308	HJ410	0.230
	130	31	2.1	2.1	70.8	-	-	NJ410EM	142.1	140.4	17.12	4 700	5 600	2.308	HJ410	0.230
	130	31	2.1	2.1	70.8	-	-	NUP410EM	142.1	140.4	17.12	4 700	5 600	2.308	-	-
130	31	2.1	2.1	-	110.8	-	N410EM	142.1	140.4	17.12	4 700	5 600	2.308	-	-	
130	31	2.1	2.1	-	110.8	-	NF410EM	142.1	140.4	17.12	4 700	5 600	2.308	-	-	
55	90	18	1.1	1.0	64.5	-	NU1011EM	41.5	50.0	6.09	7 100	8 400	0.400	-	-	
	90	18	1.1	1.0	64.5	-	NJ1011EM	41.5	50.0	6.09	7 100	8 400	0.400	-	-	
	90	18	1.1	1.0	64.5	-	NUP1011EM	41.5	50.0	6.09	7 100	8 400	0.400	-	-	
	100	21	1.5	1.1	66	-	NU211E	74.6	81.3	9.92	5 500	6 800	0.668	HJ211	0.087	
	100	21	1.5	1.1	66	-	NJ211E	74.6	81.3	9.92	5 500	6 800	0.668	HJ211	0.087	
	100	21	1.5	1.1	66	-	NUP211E	74.6	81.3	9.92	5 500	6 800	0.668	-	-	
	100	21	1.5	1.1	-	90	N211E	74.6	81.3	9.92	5 500	6 800	0.668	-	-	
	100	21	1.5	1.1	-	90	NF211E	74.6	81.3	9.92	5 500	6 800	0.668	-	-	
	100	21	1.5	1.1	66	-	NU211ETNG	86.3	98.7	12.03	5 500	6 800	0.668	HJ211	0.087	
	100	21	1.5	1.1	66	-	NJ211ETNG	86.3	98.7	12.03	5 500	6 800	0.668	HJ211	0.087	
	100	21	1.5	1.1	66	-	NUP211ETNG	86.3	98.7	12.03	5 500	6 800	0.668	-	-	
	100	21	1.5	1.1	-	90	N211ETNG	86.3	98.7	12.03	5 500	6 800	0.668	-	-	
	100	21	1.5	1.1	-	90	NF211ETNG	86.3	98.7	12.03	5 500	6 800	0.668	-	-	
	100	21	1.5	1.1	66	-	NU211EM1	82.4	92.9	11.33	5 500	6 800	0.668	HJ211	0.087	
	100	21	1.5	1.1	66	-	NJ211EM1	82.4	92.9	11.33	5 500	6 800	0.668	HJ211	0.087	
	100	21	1.5	1.1	66	-	NUP211EM1	82.4	92.9	11.33	5 500	6 800	0.668	-	-	
	100	21	1.5	1.1	-	90	N211EM1	82.4	92.9	11.33	5 500	6 800	0.668	-	-	
	100	21	1.5	1.1	-	90	NF211EM1	82.4	92.9	11.33	5 500	6 800	0.668	-	-	
	100	25	1.5	1.1	66	-	NU2211E	87.7	100.1	12.20	5 500	6 800	0.812	HJ2211	0.089	
	100	25	1.5	1.1	66	-	NJ2211E	87.7	100.1	12.20	5 500	6 800	0.812	HJ2211	0.089	
	100	25	1.5	1.1	66	-	NUP2211E	87.7	100.1	12.20	5 500	6 800	0.812	-	-	
	100	25	1.5	1.1	-	90	N2211E	87.7	100.1	12.20	5 500	6 800	0.812	-	-	
	100	25	1.5	1.1	-	90	NF2211E	87.7	100.1	12.20	5 500	6 800	0.812	-	-	
	100	25	1.5	1.1	66	-	NU2211ETNG	101.4	121.5	14.82	5 500	6 800	0.812	HJ2211	0.089	
	100	25	1.5	1.1	66	-	NJ2211ETNG	101.4	121.5	14.82	5 500	6 800	0.812	HJ2211	0.089	
	100	25	1.5	1.1	66	-	NUP2211ETNG	101.4	121.5	14.82	5 500	6 800	0.812	-	-	

Single Row Cylindrical Roller Bearings

d = 55 mm

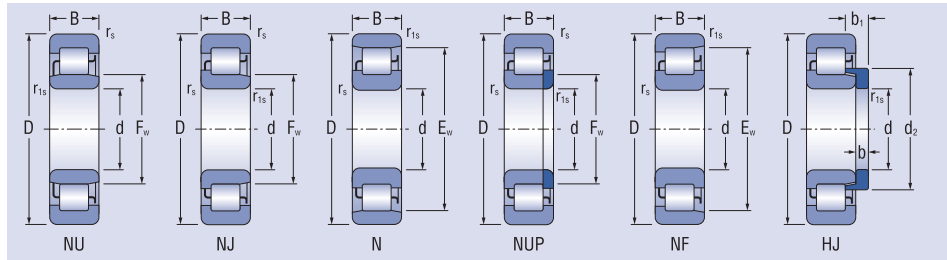

Dimensions							Bearing designation	Basic load rating		Fatigue load limit	Limiting speed for lubrication with		Mass of Bearings	Separate Thrust Collar	Mass of separate Thrust Collar
d	D	B	r _s min	r _{s1} min	F _w	E _w		C _r	C _{0r}		grease	oil			
mm							kN			min ⁻¹					
55	100	25	1.5	1.1	-	90	N2211ETNG	101.4	121.5	14.82	5 500	6 800	0.812	-	-
	100	25	1.5	1.1	-	90	NF2211ETNG	101.4	121.5	14.82	5 500	6 800	0.812	-	-
	100	25	1.5	1.1	66	-	NU2211EM1	96.9	114.4	13.95	5 500	6 800	0.812	HJ2211	0.089
	100	25	1.5	1.1	66	-	NJ2211EM1	96.9	114.4	13.95	5 500	6 800	0.812	HJ2211	0.089
	100	25	1.5	1.1	66	-	NUP2211EM1	96.9	114.4	13.95	5 500	6 800	0.812	-	-
	100	25	1.5	1.1	-	90	N2211EM1	96.9	114.4	13.95	5 500	6 800	0.812	-	-
	100	25	1.5	1.1	-	90	NF2211EM1	96.9	114.4	13.95	5 500	6 800	0.812	-	-
	120	29	2.1	2.1	70.5	-	NU311E	122.3	122.2	14.90	4 900	6 100	1.480	HJ311	0.194
	120	29	2.1	2.1	70.5	-	NJ311E	122.3	122.2	14.90	4 900	6 100	1.480	HJ311	0.194
	120	29	2.1	2.1	70.5	-	NUP311E	122.3	122.2	14.90	4 900	6 100	1.480	-	-
	120	29	2.1	2.1	-	106.5	N311E	130.4	133.3	16.25	4 900	6 100	1.480	-	-
	120	29	2.1	2.1	-	106.5	NF311E	122.3	122.2	14.90	4 900	6 100	1.480	-	-
	120	29	2.1	2.1	70.5	-	NU311ETNG	138.6	144.4	17.60	4 900	6 100	1.480	HJ311	0.194
	120	29	2.1	2.1	70.5	-	NJ311ETNG	138.6	144.4	17.60	4 900	6 100	1.480	HJ311	0.194
	120	29	2.1	2.1	70.5	-	NUP311ETNG	138.6	144.4	17.60	4 900	6 100	1.480	-	-
	120	29	2.1	2.1	-	106.5	N311ETNG	138.6	144.4	17.60	4 900	6 100	1.480	-	-
	120	29	2.1	2.1	-	106.5	NF311ETNG	138.6	144.4	17.60	4 900	6 100	1.480	-	-
	120	29	2.1	2.1	70.5	-	NU311EM	130.4	133.3	16.25	4 900	6 100	1.480	HJ311	0.194
	120	29	2.1	2.1	70.5	-	NJ311EM	130.4	133.3	16.25	4 900	6 100	1.480	HJ311	0.194
	120	29	2.1	2.1	70.5	-	NUP311EM	130.4	133.3	16.25	4 900	6 100	1.480	-	-
	120	29	2.1	2.1	-	106.5	N311EM	130.4	133.3	16.25	4 900	6 100	1.480	-	-
	120	29	2.1	2.1	-	106.5	NF311EM	130.4	133.3	16.25	4 900	6 100	1.480	-	-
	120	29	2.1	2.1	70.5	-	NU311EM1	138.6	144.4	17.60	4 900	6 100	1.480	HJ311	0.194
	120	29	2.1	2.1	70.5	-	NJ311EM1	138.6	144.4	17.60	4 900	6 100	1.480	HJ311	0.194
	120	29	2.1	2.1	70.5	-	NUP311EM1	138.6	144.4	17.60	4 900	6 100	1.480	-	-
	120	29	2.1	2.1	-	106.5	N311EM1	138.6	144.4	17.60	4 900	6 100	1.480	-	-
	120	29	2.1	2.1	-	106.5	NF311EM1	138.6	144.4	17.60	4 900	6 100	1.480	-	-
	120	43	2.1	2.1	70.5	-	NU2311E	178.4	198.5	24.21	5 000	6 100	2.270	HJ2311	0.202
	120	43	2.1	2.1	70.5	-	NJ2311E	178.4	198.5	24.21	5 000	6 100	2.270	HJ2311	0.202
	120	43	2.1	2.1	70.5	-	NUP2311E	178.4	198.5	24.21	5 000	6 100	2.270	-	-
	120	43	2.1	2.1	-	106.5	N2311E	178.4	198.5	24.21	5 000	6 100	2.270	-	-
	120	43	2.1	2.1	-	106.5	NF2311E	178.4	198.5	24.21	5 000	6 100	2.270	-	-
	120	43	2.1	2.1	70.5	-	NU2311EM	190.2	216.5	26.41	5 000	6 100	2.270	HJ2311	0.202
	120	43	2.1	2.1	70.5	-	NJ2311EM	190.2	216.5	26.41	5 000	6 100	2.270	HJ2311	0.202
	120	43	2.1	2.1	70.5	-	NUP2311EM	190.2	216.5	26.41	5 000	6 100	2.270	-	-
	120	43	2.1	2.1	-	106.5	N2311EM	190.2	216.5	26.41	5 000	6 100	2.270	-	-
	120	43	2.1	2.1	-	106.5	NF2311EM	190.2	216.5	26.41	5 000	6 100	2.270	-	-
	120	43	2.1	2.1	70.5	-	NU2311EM1	202.2	234.6	28.61	5 000	6 100	2.270	HJ2311	0.202
	120	43	2.1	2.1	70.5	-	NJ2311EM1	202.2	234.6	28.61	5 000	6 100	2.270	HJ2311	0.202
	120	43	2.1	2.1	70.5	-	NUP2311EM1	202.2	234.6	28.61	5 000	6 100	2.270	-	-
120	43	2.1	2.1	-	106.5	N2311EM1	202.2	234.6	28.61	5 000	6 100	2.270	-	-	
120	43	2.1	2.1	-	106.5	NF2311EM1	202.2	234.6	28.61	5 000	6 100	2.270	-	-	

Single Row Cylindrical Roller Bearings

d = 55 - 60 mm

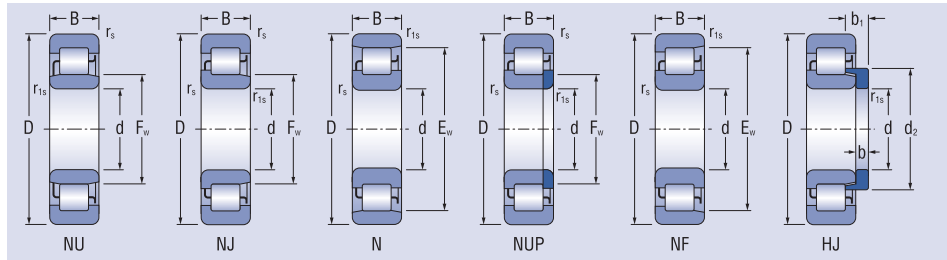

Dimensions							Bearing designation	Basic load rating		Fatigue load limit	Limiting speed for lubrication with		Mass of Bearings	Separate Thrust Collar	Mass of separate Thrust Collar
d	D	B	r _s min	r _{s1} min	F _w	E _w		C _r	C _{0r}		grease	oil			
mm							kN			min ⁻¹					
55	140	33	2.1	2.1	77.2	-	NU411EM	152.4	156.0	19.02	4 500	5 300	2.549	HJ411	0.300
	140	33	2.1	2.1	77.2	-	NJ411EM	152.4	156.0	19.02	4 500	5 300	2.549	HJ411	0.300
	140	33	2.1	2.1	77.2	-	NUP411EM	152.4	156.0	19.02	4 500	5 300	2.549	-	-
	140	33	2.1	2.1	-	117.2	N411EM	152.4	156.0	19.02	4 500	5 300	2.549	-	-
	140	33	2.1	2.1	-	117.2	NF411EM	152.4	156.0	19.02	4 500	5 300	2.549	-	-
60	95	18	1.1	1.0	69.5	-	NU1012EM	44.0	55.0	6.70	6 700	7 900	0.478	-	-
	95	18	1.1	1.0	69.5	-	NJ1012EM	44.0	55.0	6.70	6 700	7 900	0.478	-	-
	95	18	1.1	1.0	69.5	-	NUP1012EM	44.0	55.0	6.70	6 700	7 900	0.478	-	-
	110	22	1.5	1.5	72	-	NU212E	87.2	92.4	11.27	5 100	6 200	0.827	HJ212	0.108
	110	22	1.5	1.5	72	-	NJ212E	87.2	92.4	11.27	5 100	6 200	0.827	HJ212	0.108
	110	22	1.5	1.5	72	-	NUP212E	87.2	92.4	11.27	5 100	6 200	0.827	-	-
	110	22	1.5	1.5	-	100	N212E	91.8	99.0	12.08	5 100	6 200	0.827	-	-
	110	22	1.5	1.5	-	100	NF212E	87.2	92.4	11.27	5 100	6 200	0.827	-	-
	110	22	1.5	1.5	72	-	NU212ETNG	96.4	105.6	12.88	5 100	6 200	0.827	HJ212	0.108
	110	22	1.5	1.5	72	-	NJ212ETNG	96.4	105.6	12.88	5 100	6 200	0.827	HJ212	0.108
	110	22	1.5	1.5	72	-	NUP212ETNG	96.4	105.6	12.88	5 100	6 200	0.827	-	-
	110	22	1.5	1.5	-	100	N212ETNG	96.4	105.6	12.88	5 100	6 200	0.827	-	-
	110	22	1.5	1.5	-	100	NF212ETNG	96.4	105.6	12.88	5 100	6 200	0.827	-	-
	110	22	1.5	1.5	72	-	NU212EM1	96.4	105.6	12.88	5 100	6 200	0.827	HJ212	0.108
	110	22	1.5	1.5	72	-	NJ212EM1	96.4	105.6	12.88	5 100	6 200	0.827	HJ212	0.108
	110	22	1.5	1.5	72	-	NUP212EM1	96.4	105.6	12.88	5 100	6 200	0.827	-	-
	110	22	1.5	1.5	-	100	N212EM1	96.4	105.6	12.88	5 100	6 200	0.827	-	-
	110	22	1.5	1.5	-	100	NF212EM1	96.4	105.6	12.88	5 100	6 200	0.827	-	-
	110	28	1.5	1.5	72	-	NU2212E	111.2	126.0	15.37	5 100	6 200	1.100	HJ2212	0.108
	110	28	1.5	1.5	72	-	NJ2212E	111.2	126.0	15.37	5 100	6 200	1.100	HJ2212	0.108
	110	28	1.5	1.5	72	-	NUP2212E	111.2	126.0	15.37	5 100	6 200	1.100	-	-
	110	28	1.5	1.5	-	100	N2212E	111.2	126.0	15.37	5 100	6 200	1.100	-	-
	110	28	1.5	1.5	-	100	NF2212E	111.2	126.0	15.37	5 100	6 200	1.100	-	-
	110	28	1.5	1.5	72	-	NU2212ETNG	130.0	155.1	18.92	5 100	6 200	1.100	HJ2212	0.108
	110	28	1.5	1.5	72	-	NJ2212ETNG	130.0	155.1	18.92	5 100	6 200	1.100	HJ2212	0.108
	110	28	1.5	1.5	72	-	NUP2212ETNG	130.0	155.1	18.92	5 100	6 200	1.100	-	-
	110	28	1.5	1.5	-	100	N2212ETNG	130.0	155.1	18.92	5 100	6 200	1.100	-	-
	110	28	1.5	1.5	-	100	NF2212ETNG	130.0	155.1	18.92	5 100	6 200	1.100	-	-
	110	28	1.5	1.5	72	-	NU2212EM	117.6	135.7	16.6	5 100	6 200	1.100	HJ2212	0.108
	110	28	1.5	1.5	72	-	NJ2212EM	117.6	135.7	16.6	5 100	6 200	1.100	HJ2212	0.108
	110	28	1.5	1.5	72	-	NUP2212EM	117.6	135.7	16.6	5 100	6 200	1.100	-	-
	110	28	1.5	1.5	-	100	N2212EM	117.6	135.7	16.6	5 100	6 200	1.100	-	-
110	28	1.5	1.5	-	100	NF2212EM	117.6	135.7	16.6	5 100	6 200	1.100	-	-	
110	28	1.5	1.5	72	-	NU2212EM1	130.0	155.1	18.92	5 100	6 200	1.100	HJ2212	0.108	
110	28	1.5	1.5	72	-	NJ2212EM1	130.0	155.1	18.92	5 100	6 200	1.100	HJ2212	0.108	
110	28	1.5	1.5	72	-	NUP2212EM1	130.0	155.1	18.92	5 100	6 200	1.100	-	-	
110	28	1.5	1.5	-	100	N2212EM1	130.0	155.1	18.92	5 100	6 200	1.100	-	-	

Single Row Cylindrical Roller Bearings

d = 60 mm

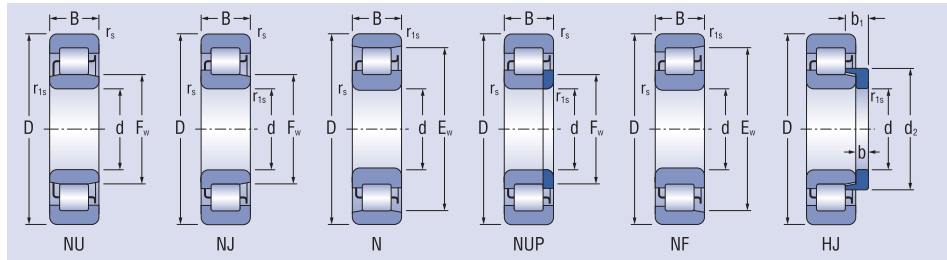

Dimensions							Bearing designation	Basic load rating		Fatigue load limit	Limiting speed for lubrication with		Mass of Bearings	Separate Thrust Collar	Mass of separate Thrust Collar
d	D	B	r _s min	r _{s1} min	F _w	E _w		C _r	C _{0r}		grease	oil			
mm							kN			min ⁻¹					
60	110	28	1.5	1.5	-	100	NF2212EM1	130.0	155.1	18.92	5 100	6 200	1.100	-	-
	130	31	2.1	2.1	77	-	NU312E	135.3	137.2	16.73	4 500	5 600	1.840	HJ312	0.231
	130	31	2.1	2.1	77	-	NJ312E	135.3	137.2	16.73	4 500	5 600	1.840	HJ312	0.231
	130	31	2.1	2.1	77	-	NUP312E	135.3	137.2	16.73	4 500	5 600	1.840	-	-
	130	31	2.1	2.1	-	115	N312E	144.4	149.7	18.25	4 500	5 600	1.840	-	-
	130	31	2.1	2.1	-	115	NF312E	135.3	137.2	16.73	4 500	5 600	1.840	-	-
	130	31	2.1	2.1	77	-	NU312ETNG	153.3	162.1	19.77	4 500	5 600	1.840	HJ312	0.231
	130	31	2.1	2.1	77	-	NJ312ETNG	153.3	162.1	19.77	4 500	5 600	1.840	HJ312	0.231
	130	31	2.1	2.1	77	-	NUP312ETNG	153.3	162.1	19.77	4 500	5 600	1.840	-	-
	130	31	2.1	2.1	-	115	N312ETNG	153.3	162.1	19.77	4 500	5 600	1.840	-	-
	130	31	2.1	2.1	-	115	NF312ETNG	153.3	162.1	19.77	4 500	5 600	1.840	-	-
	130	31	2.1	2.1	77	-	NU312EM	144.4	149.7	18.25	4 500	5 600	1.840	HJ312	0.231
	130	31	2.1	2.1	77	-	NJ312EM	144.4	149.7	18.25	4 500	5 600	1.840	HJ312	0.231
	130	31	2.1	2.1	77	-	NUP312EM	144.4	149.7	18.25	4 500	5 600	1.840	-	-
	130	31	2.1	2.1	-	115	N312EM	144.4	149.7	18.25	4 500	5 600	1.840	-	-
	130	31	2.1	2.1	-	115	NF312EM	144.4	149.7	18.25	4 500	5 600	1.840	-	-
	130	31	2.1	2.1	77	-	NU312EM1	150.0	156.0	19.02	4 500	5 600	1.840	HJ312	0.231
	130	31	2.1	2.1	77	-	NJ312EM1	153.3	162.1	19.77	4 500	5 600	1.840	HJ312	0.231
	130	31	2.1	2.1	77	-	NUP312EM1	153.3	162.1	19.77	4 500	5 600	1.840	-	-
	130	31	2.1	2.1	-	115	N312EM1	153.3	162.1	19.77	4 500	5 600	1.840	-	-
	130	31	2.1	2.1	-	115	NF312EM1	153.3	162.1	19.77	4 500	5 600	1.840	-	-
	130	46	1.5	1.5	77	-	NU2312E	199.3	225.7	27.52	4 500	5 600	2.830	HJ2312	0.241
	130	46	1.5	1.5	77	-	NJ2312E	199.3	225.7	27.52	4 500	5 600	2.830	HJ2312	0.241
	130	46	1.5	1.5	77	-	NUP2312E	199.3	225.7	27.52	4 500	5 600	2.830	-	-
	130	46	1.5	1.5	-	115	N2312E	206.8	240.0	29.26	4 500	5 600	2.830	-	-
	130	46	1.5	1.5	-	115	NF2312E	199.3	225.7	27.52	4 500	5 600	2.830	-	-
	130	46	1.5	1.5	77	-	NU2312EM	206.8	240.0	29.26	4 500	5 600	2.830	HJ2312	0.241
	130	46	1.5	1.5	77	-	NJ2312EM	206.8	240.0	29.26	4 500	5 600	2.830	HJ2312	0.241
	130	46	1.5	1.5	77	-	NUP2312EM	206.8	240.0	29.26	4 500	5 600	2.830	-	-
	130	46	1.5	1.5	-	115	N2312EM	206.8	240.0	29.26	4 500	5 600	2.830	-	-
	130	46	1.5	1.5	-	115	NF2312EM	206.8	240.0	29.26	4 500	5 600	2.830	-	-
	130	46	1.5	1.5	77	-	NU2312EM1	225.9	266.7	32.53	4 500	5 600	2.830	HJ2312	0.241
	130	46	1.5	1.5	77	-	NJ2312EM1	225.9	266.7	32.53	4 500	5 600	2.830	HJ2312	0.241
	130	46	1.5	1.5	77	-	NUP2312EM1	225.9	266.7	32.53	4 500	5 600	2.830	-	-
	130	46	1.5	1.5	-	115	N2312EM1	225.9	266.7	32.53	4 500	5 600	2.830	-	-
	130	46	1.5	1.5	-	115	NF2312EM1	225.9	266.7	32.53	4 500	5 600	2.830	-	-
	150	35	2.1	2.1	83	-	NU412EM	189.6	194.0	23.25	3 900	4 600	3.510	HJ412	0.340
	150	35	2.1	2.1	83	-	NJ412EM	189.6	194.0	23.25	3 900	4 600	3.510	HJ412	0.340
	150	35	2.1	2.1	83	-	NUP412EM	189.6	194.0	23.25	3 900	4 600	3.510	-	-
	150	35	2.1	2.1	-	127	N412EM	189.6	194.0	23.25	3 900	4 600	3.510	-	-
150	35	2.1	2.1	-	127	NF412EM	189.6	194.0	23.25	3 900	4 600	3.510	-	-	

Single Row Cylindrical Roller Bearings

d = 65 mm

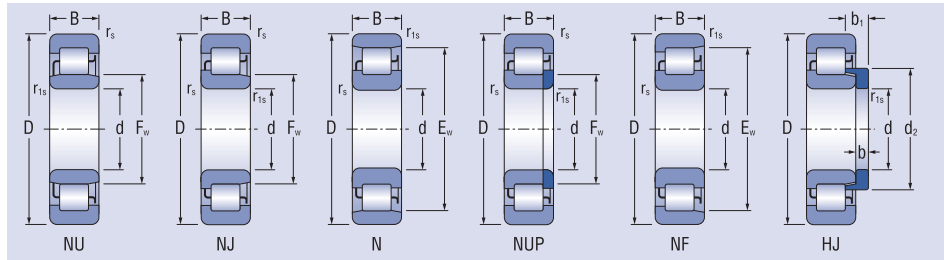

Dimensions							Bearing designation	Basic load rating		Fatigue load limit	Limiting speed for lubrication with		Mass of Bearings	Separate Thrust Collar	Mass of separate Thrust Collar
d	D	B	r _s min	r _{s1} min	F _w	E _w		C _r	C _{0r}		grease	oil			
mm							kN			min ⁻¹					
65	100	18	1.1	1.0	74.5	-	NU1013EM	45.0	58.5	7.13	6 300	7 500	0.512	-	-
	100	18	1.1	1.0	74.5	-	NJ1013EM	45.0	58.5	7.13	6 300	7 500	0.512	-	-
	100	18	1.1	1.0	74.5	-	NUP1013EM	45.0	58.5	7.13	6 300	7 500	0.512	-	-
	120	23	1.5	1.5	78.5	-	NU213E	99.5	107.1	13.06	4 600	5 700	1.050	HJ213	0.129
	120	23	1.5	1.5	78.5	-	NJ213E	99.5	107.1	13.06	4 600	5 700	1.050	HJ213	0.129
	120	23	1.5	1.5	78.5	-	NUP213E	99.5	107.1	13.06	4 600	5 700	1.050	-	-
	120	23	1.5	1.5	-	108.5	N213E	104.8	114.7	14.00	4 600	5 700	1.050	-	-
	120	23	1.5	1.5	-	108.5	NF213E	99.5	107.1	13.06	4 600	5 700	1.050	-	-
	120	23	1.5	1.5	78.5	-	NU213ETNG	110.0	122.4	14.92	4 600	5 700	1.050	HJ213	0.129
	120	23	1.5	1.5	78.5	-	NJ213ETNG	110.0	122.4	14.92	4 600	5 700	1.050	HJ213	0.129
	120	23	1.5	1.5	78.5	-	NUP213ETNG	110.0	122.4	14.92	4 600	5 700	1.050	-	-
	120	23	1.5	1.5	-	108.5	N213ETNG	110.0	122.4	14.92	4 600	5 700	1.050	-	-
	120	23	1.5	1.5	-	108.5	NF213ETNG	110.0	122.4	14.92	4 600	5 700	1.050	-	-
	120	23	1.5	1.5	78.5	-	NU213EM1	110.0	122.4	14.92	4 600	5 700	1.050	HJ213	0.129
	120	23	1.5	1.5	78.5	-	NJ213EM1	110.0	122.4	14.92	4 600	5 700	1.050	HJ213	0.129
	120	23	1.5	1.5	78.5	-	NUP213EM1	110.0	122.4	14.92	4 600	5 700	1.050	-	-
	120	23	1.5	1.5	-	108.5	N213EM1	110.0	122.4	14.92	4 600	5 700	1.050	-	-
	120	23	1.5	1.5	-	108.5	NF213EM1	110.0	122.4	14.92	4 600	5 700	1.050	-	-
	120	31	1.5	1.5	78.5	-	NU2213E	129.5	149.8	18.27	4 600	5 700	1.460	HJ2213	0.132
	120	31	1.5	1.5	78.5	-	NJ2213E	129.5	149.8	18.27	4 600	5 700	1.460	HJ2213	0.132
	120	31	1.5	1.5	78.5	-	NUP2213E	129.5	149.8	18.27	4 600	5 700	1.460	-	-
	120	31	1.5	1.5	-	108.5	N2213E	129.5	149.8	18.27	4 600	5 700	1.460	-	-
	120	31	1.5	1.5	-	108.5	NF2213E	129.5	149.8	18.27	4 600	5 700	1.460	-	-
	120	31	1.5	1.5	78.5	-	NU2213ETNG	151.3	184.4	22.49	4 600	5 700	1.460	HJ2213	0.132
	120	31	1.5	1.5	78.5	-	NJ2213ETNG	151.3	184.4	22.49	4 600	5 700	1.460	HJ2213	0.132
	120	31	1.5	1.5	78.5	-	NUP2213ETNG	151.3	184.4	22.49	4 600	5 700	1.460	-	-
	120	31	1.5	1.5	-	108.5	N2213ETNG	151.3	184.4	22.49	4 600	5 700	1.460	-	-
	120	31	1.5	1.5	-	108.5	NF2213ETNG	151.3	184.4	22.49	4 600	5 700	1.460	-	-
	120	31	1.5	1.5	78.5	-	NU2213EM1	151.3	184.4	22.49	4 600	5 700	1.460	HJ2213	0.132
	120	31	1.5	1.5	78.5	-	NJ2213EM1	151.3	184.4	22.49	4 600	5 700	1.460	HJ2213	0.132
	120	31	1.5	1.5	78.5	-	NUP2213EM1	151.3	184.4	22.49	4 600	5 700	1.460	-	-
	120	31	1.5	1.5	-	108.5	N2213EM1	151.3	184.4	22.49	4 600	5 700	1.460	-	-
	120	31	1.5	1.5	-	108.5	NF2213EM1	151.3	184.4	22.49	4 600	5 700	1.460	-	-
	140	33	2.1	2.1	82.5	-	NU313E	161.9	165.3	20.01	4 200	5 200	1.280	HJ313	0.287
	140	33	2.1	2.1	82.5	-	NJ313E	161.9	165.3	20.01	4 200	5 200	1.280	HJ313	0.287
	140	33	2.1	2.1	82.5	-	NUP313E	161.9	165.3	20.01	4 200	5 200	1.280	-	-
	140	33	2.1	2.1	-	124.5	N313E	172.6	180.3	21.83	4 200	5 200	1.280	-	-
	140	33	2.1	2.1	-	124.5	NF313E	161.9	165.3	20.01	4 200	5 200	1.280	-	-
	140	33	2.1	2.1	82.5	-	NU313ETNG	183.5	195.3	23.64	4 200	5 200	1.280	HJ313	0.287
	140	33	2.1	2.1	82.5	-	NJ313ETNG	183.5	195.3	23.64	4 200	5 200	1.280	HJ313	0.287
	140	33	2.1	2.1	82.5	-	NUP313ETNG	183.5	195.3	23.64	4 200	5 200	1.280	-	-
	140	33	2.1	2.1	-	124.5	N313ETNG	183.5	195.3	23.64	4 200	5 200	1.280	-	-

Single Row Cylindrical Roller Bearings

d = 65 - 70 mm

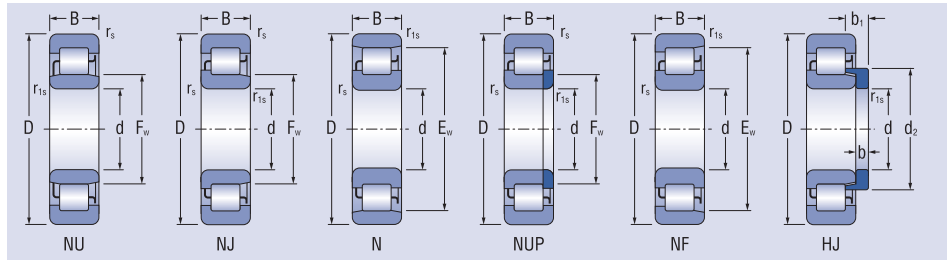

Dimensions							Bearing designation	Basic load rating		Fatigue load limit	Limiting speed		Mass of Bearings	Separate Thrust Collar	Mass of separate Thrust Collar
d	D	B	rs min	rs1 min	Fw	Ew		Cr	Cor		for lubrication with grease	oil			
mm							kN			min ⁻¹					
65	140	33	2.1	2.1	-	124.5	NF313ETNG	183.5	195.3	23.64	4 200	5 200	1.280	-	-
	140	33	2.1	2.1	82.5	-	NU313EM	172.6	180.3	21.83	4 200	5 200	1.280	HJ313	0.287
	140	33	2.1	2.1	82.5	-	NJ313EM	172.6	180.3	21.83	4 200	5 200	1.280	HJ313	0.287
	140	33	2.1	2.1	82.5	-	NUP313EM	172.6	180.3	21.83	4 200	5 200	1.280	-	-
	140	33	2.1	2.1	-	124.5	N313EM	172.6	180.3	21.83	4 200	5 200	1.280	-	-
	140	33	2.1	2.1	-	124.5	NF313EM	172.6	180.3	21.83	4 200	5 200	1.280	-	-
	140	33	2.1	2.1	82.5	-	NU313EM1	183.5	195.3	23.64	4 200	5 200	1.280	HJ313	0.287
	140	33	2.1	2.1	82.5	-	NJ313EM1	183.5	195.3	23.64	4 200	5 200	1.280	HJ313	0.287
	140	33	2.1	2.1	82.5	-	NUP313EM1	183.5	195.3	23.64	4 200	5 200	1.280	-	-
	140	33	2.1	2.1	-	124.5	N313EM1	183.5	195.3	23.64	4 200	5 200	1.280	-	-
	140	33	2.1	2.1	-	124.5	NF313EM1	183.5	195.3	23.64	4 200	5 200	1.280	-	-
	140	48	2.1	2.1	82.5	-	NU2313E	221.6	247.9	30.23	4 200	5 200	3.380	HJ2313	0.306
	140	48	2.1	2.1	82.5	-	NJ2313E	221.6	247.9	30.23	4 200	5 200	3.380	HJ2313	0.306
	140	48	2.1	2.1	82.5	-	NUP2313E	221.6	247.9	30.23	4 200	5 200	3.380	-	-
	140	48	2.1	2.1	-	124.5	N2313E	235.4	268.7	32.77	4 200	5 200	3.380	-	-
	140	48	2.1	2.1	-	124.5	NF2313E	221.6	247.9	30.23	4 200	5 200	3.380	-	-
	140	48	2.1	2.1	82.5	-	NU2313EM	235.4	268.7	32.77	4 200	5 200	3.380	HJ2313	0.306
	140	48	2.1	2.1	82.5	-	NJ2313EM	235.4	268.7	32.77	4 200	5 200	3.380	HJ2313	0.306
	140	48	2.1	2.1	82.5	-	NUP2313EM	235.4	268.7	32.77	4 200	5 200	3.380	-	-
	140	48	2.1	2.1	-	124.5	N2313EM	235.4	268.7	32.77	4 200	5 200	3.380	-	-
	140	48	2.1	2.1	-	124.5	NF2313EM	235.4	268.7	32.77	4 200	5 200	3.380	-	-
	140	48	2.1	2.1	82.5	-	NU2313EM1	249.9	291.1	35.50	4 200	5 200	3.380	HJ2313	0.306
	140	48	2.1	2.1	82.5	-	NJ2313EM1	249.9	291.1	35.50	4 200	5 200	3.380	HJ2313	0.306
	140	48	2.1	2.1	82.5	-	NUP2313EM1	249.9	291.1	35.50	4 200	5 200	3.380	-	-
	140	48	2.1	2.1	-	124.5	N2313EM1	249.9	291.1	35.50	4 200	5 200	3.380	-	-
	140	48	2.1	2.1	-	124.5	NF2313EM1	249.9	291.1	35.50	4 200	5 200	3.380	-	-
	160	37	2.1	2.1	89.5	-	NU413EM	204.7	216.4	25.48	3 600	4 300	4.180	HJ413	0.420
	160	37	2.1	2.1	89.5	-	NJ413EM	204.7	216.4	25.48	3 600	4 300	4.180	HJ413	0.420
160	37	2.1	2.1	89.5	-	NUP413EM	204.7	216.4	25.48	3 600	4 300	4.180	-	-	
160	37	2.1	2.1	-	135.5	N413EM	204.7	216.4	25.48	3 600	4 300	4.180	-	-	
160	37	2.1	2.1	-	135.5	NF413EM	204.7	216.4	25.48	3 600	4 300	4.180	-	-	
70	110	20	1.1	1.0	80	-	NU1014EM	64.0	81.5	9.94	5 600	6 700	0.706	-	-
	110	20	1.1	1.0	80	-	NJ1014EM	64.0	81.5	9.94	5 600	6 700	0.706	-	-
	110	20	1.1	1.0	80	-	NUP1014EM	64.0	81.5	9.94	5 600	6 700	0.706	-	-
	125	24	1.5	1.5	83.5	-	NU214E	110.3	124.2	15.15	4 400	5 400	1.160	HJ214	0.156
	125	24	1.5	1.5	83.5	-	NJ214E	110.3	124.2	15.15	4 400	5 400	1.160	HJ214	0.156
	125	24	1.5	1.5	83.5	-	NUP214E	110.3	124.2	15.15	4 400	5 400	1.160	-	-
	125	24	1.5	1.5	-	113.5	N214E	115.8	132.5	16.16	4 400	5 400	1.160	-	-
	125	24	1.5	1.5	-	113.5	NF214E	110.3	124.2	15.15	4 400	5 400	1.160	-	-
	125	24	1.5	1.5	83.5	-	NU214ETNG	121.2	140.8	17.17	4 400	5 400	1.160	HJ214	0.156
	125	24	1.5	1.5	83.5	-	NJ214ETNG	121.2	140.8	17.17	4 400	5 400	1.160	HJ214	0.156
	125	24	1.5	1.5	83.5	-	NUP214ETNG	121.2	140.8	17.17	4 400	5 400	1.160	-	-

Single Row Cylindrical Roller Bearings

d = 70 mm

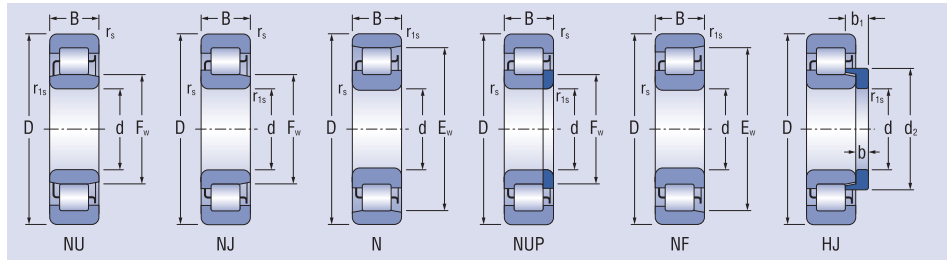

Dimensions							Bearing designation	Basic load rating		Fatigue load limit	Limiting speed for lubrication with		Mass of Bearings	Separate Thrust Collar	Mass of separate Thrust Collar
d	D	B	r _s min	r _{s1} min	F _w	E _w		C _r	C _{0r}		grease	oil			
mm							kN			min ⁻¹					
70	125	24	1.5	1.5	-	113.5	N214ETNG	121.2	140.8	17.17	4 400	5 400	1.160	-	-
	125	24	1.5	1.5	-	113.5	NF214ETNG	121.2	140.8	17.17	4 400	5 400	1.160	-	-
	125	24	1.5	1.5	83.5	-	NU214EM	110.3	124.2	15.15	4 400	5 400	1.160	HJ214	0.156
	125	24	1.5	1.5	83.5	-	NJ214EM	110.3	124.2	15.15	4 400	5 400	1.160	HJ214	0.156
	125	24	1.5	1.5	83.5	-	NUP214EM	110.3	124.2	15.15	4 400	5 400	1.160	-	-
	125	24	1.5	1.5	-	113.5	N214EM	110.3	124.2	15.15	4 400	5 400	1.160	-	-
	125	24	1.5	1.5	-	113.5	NF214EM	110.3	124.2	15.15	4 400	5 400	1.160	-	-
	125	24	1.5	1.5	83.5	-	NU214EM1	121.2	140.8	17.17	4 400	5 400	1.160	HJ214	0.156
	125	24	1.5	1.5	83.5	-	NJ214EM1	121.2	140.8	17.17	4 400	5 400	1.160	HJ214	0.156
	125	24	1.5	1.5	83.5	-	NUP214EM1	121.2	140.8	17.17	4 400	5 400	1.160	-	-
	125	24	1.5	1.5	-	113.5	N214EM1	121.2	140.8	17.17	4 400	5 400	1.160	-	-
	125	24	1.5	1.5	-	113.5	NF214EM1	121.2	140.8	17.17	4 400	5 400	1.160	-	-
	125	31	1.5	1.5	83.5	-	NU2214E	136.5	162.9	19.87	4 400	5 400	1.550	HJ2214	0.159
	125	31	1.5	1.5	83.5	-	NJ2214E	136.5	162.9	19.87	4 400	5 400	1.550	HJ2214	0.159
	125	31	1.5	1.5	83.5	-	NUP2214E	136.5	162.9	19.87	4 400	5 400	1.550	-	-
	125	31	1.5	1.5	-	113.5	N2214E	136.5	162.9	19.87	4 400	5 400	1.550	-	-
	125	31	1.5	1.5	-	113.5	NF2214E	136.5	162.9	19.87	4 400	5 400	1.550	-	-
	125	31	1.5	1.5	83.5	-	NU2214ETNG	157.9	197.8	24.13	4 400	5 400	1.550	HJ2214	0.159
	125	31	1.5	1.5	83.5	-	NJ2214ETNG	157.9	197.8	24.13	4 400	5 400	1.550	HJ2214	0.159
	125	31	1.5	1.5	83.5	-	NUP2214ETNG	157.9	197.8	24.13	4 400	5 400	1.550	-	-
	125	31	1.5	1.5	-	113.5	N2214ETNG	157.9	197.8	24.13	4 400	5 400	1.550	-	-
	125	31	1.5	1.5	-	113.5	NF2214ETNG	157.9	197.8	24.13	4 400	5 400	1.550	-	-
	125	31	1.5	1.5	83.5	-	NU2214EM1	157.9	197.8	24.13	4 400	5 400	1.550	HJ2214	0.159
	125	31	1.5	1.5	83.5	-	NJ2214EM1	157.9	197.8	24.13	4 400	5 400	1.550	HJ2214	0.159
	125	31	1.5	1.5	83.5	-	NUP2214EM1	157.9	197.8	24.13	4 400	5 400	1.550	-	-
	125	31	1.5	1.5	-	113.5	N2214EM1	157.9	197.8	24.13	4 400	5 400	1.550	-	-
	125	31	1.5	1.5	-	113.5	NF2214EM1	157.9	197.8	24.13	4 400	5 400	1.550	-	-
	150	35	2.1	2.1	89	-	NU314E	183.0	191.2	22.66	3 900	4 800	2.790	HJ314	0.331
	150	35	2.1	2.1	89	-	NJ314E	183.0	191.2	22.66	3 900	4 800	2.790	HJ314	0.331
	150	35	2.1	2.1	89	-	NUP314E	183.0	191.2	22.66	3 900	4 800	2.790	-	-
	150	35	2.1	2.1	-	133	N314E	195.3	208.6	24.73	3 900	4 800	2.790	-	-
	150	35	2.1	2.1	-	133	NF314E	183.0	191.2	22.66	3 900	4 800	2.790	-	-
	150	35	2.1	2.1	89	-	NU314ETNG	207.4	226.0	26.79	3 900	4 800	2.790	HJ314	0.331
	150	35	2.1	2.1	89	-	NJ314ETNG	207.4	226.0	26.79	3 900	4 800	2.790	HJ314	0.331
	150	35	2.1	2.1	89	-	NUP314ETNG	207.4	226.0	26.79	3 900	4 800	2.790	-	-
	150	35	2.1	2.1	-	133	N314ETNG	207.4	226.0	26.79	3 900	4 800	2.790	-	-
	150	35	2.1	2.1	-	133	NF314ETNG	207.4	226.0	26.79	3 900	4 800	2.790	-	-
	150	35	2.1	2.1	89	-	NU314EM	195.3	208.6	24.73	3 900	4 800	2.790	HJ314	0.331
	150	35	2.1	2.1	89	-	NJ314EM	195.3	208.6	24.73	3 900	4 800	2.790	HJ314	0.331
	150	35	2.1	2.1	89	-	NUP314EM	195.3	208.6	24.73	3 900	4 800	2.790	-	-
	150	35	2.1	2.1	-	133	N314EM	195.3	208.6	24.73	3 900	4 800	2.790	-	-
	150	35	2.1	2.1	-	133	NF314EM	195.3	208.6	24.73	3 900	4 800	2.790	-	-

Single Row Cylindrical Roller Bearings

d = 70 - 75 mm

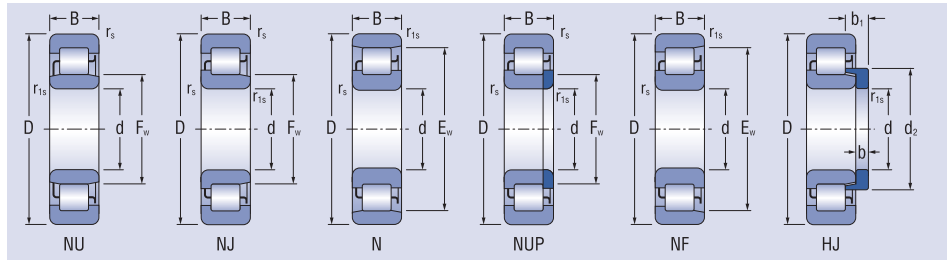

Dimensions							Bearing designation	Basic load rating		Fatigue load limit	Limiting speed for lubrication with		Mass of Bearings	Separate Thrust Collar	Mass of separate Thrust Collar	
d	D	B	r _s min	r _{s1} min	F _w	E _w		C _r	C _{0r}		grease	oil				kg
mm							kN			min ⁻¹						
70	150	35	2.1	2.1	89	-	NU314EM1	207.4	226.0	26.79	3 900	4 800	2.790	HJ314	0.331	
	150	35	2.1	2.1	89	-	NJ314EM1	207.4	226.0	26.79	3 900	4 800	2.790	HJ314	0.331	
	150	35	2.1	2.1	89	-	NUP314EM1	207.4	226.0	26.79	3 900	4 800	2.790	-	-	
	150	35	2.1	2.1	-	133	N314EM1	207.4	226.0	26.79	3 900	4 800	2.790	-	-	
	150	35	2.1	2.1	-	133	NF314EM1	207.4	226.0	26.79	3 900	4 800	2.790	-	-	
	150	51	2.1	2.1	89	-	NU2314E	243.8	276.6	33.73	3 900	4 800	4.090	HJ2314	0.355	
	150	51	2.1	2.1	89	-	NJ2314E	243.8	276.6	33.73	3 900	4 800	4.090	HJ2314	0.355	
	150	51	2.1	2.1	89	-	NUP2314E	243.8	276.6	33.73	3 900	4 800	4.090	-	-	
	150	51	2.1	2.1	-	133	N2314E	260.3	301.8	36.80	3 900	4 800	4.090	-	-	
	150	51	2.1	2.1	-	133	NF2314E	243.8	276.6	33.73	3 900	4 800	4.090	-	-	
	150	51	2.1	2.1	89	-	NU2314EM	260.3	301.8	36.80	3 900	4 800	4.090	HJ2314	0.355	
	150	51	2.1	2.1	89	-	NJ2314EM	260.3	301.8	36.80	3 900	4 800	4.090	HJ2314	0.355	
	150	51	2.1	2.1	89	-	NUP2314EM	260.3	301.8	36.80	3 900	4 800	4.090	-	-	
	150	51	2.1	2.1	-	133	N2314EM	260.3	301.8	36.80	3 900	4 800	4.090	-	-	
	150	51	2.1	2.1	-	133	NF2314EM	260.3	301.8	36.80	3 900	4 800	4.090	-	-	
	150	51	2.1	2.1	89	-	NU2314EM1	276.4	326.4	39.87	3 900	4 800	4.090	HJ2314	0.355	
	150	51	2.1	2.1	89	-	NJ2314EM1	276.4	326.4	39.87	3 900	4 800	4.090	HJ2314	0.355	
	150	51	2.1	2.1	89	-	NUP2314EM1	276.4	326.4	39.87	3 900	4 800	4.090	-	-	
	150	51	2.1	2.1	-	133	N2314EM1	276.4	326.4	39.87	3 900	4 800	4.090	-	-	
	150	51	2.1	2.1	-	133	NF2314EM1	276.4	326.4	39.87	3 900	4 800	4.090	-	-	
180	180	42	3.0	3.0	100	-	NU414EM	265.3	287.6	32.73	3 400	4 000	5.970	HJ414	0.610	
	180	42	3.0	3.0	100	-	NJ414EM	265.3	287.6	32.73	3 400	4 000	5.970	HJ414	0.610	
	180	42	3.0	3.0	100	-	NUP414EM	265.3	287.6	32.73	3 400	4 000	5.970	-	-	
	180	42	3.0	3.0	-	152	N414EM	265.3	287.6	32.73	3 400	4 000	5.970	-	-	
	180	42	3.0	3.0	-	152	NF414EM	265.3	287.6	32.73	3 400	4 000	5.970	-	-	
	75	115	20	1.1	1.0	85	-	NU1015EM	65.5	85.0	10.36	5 300	6 300	0.750	-	-
		115	20	1.1	1.0	85	-	NJ1015EM	65.5	85.0	10.36	5 300	6 300	0.750	-	-
		115	20	1.1	1.0	85	-	NUP1015EM	65.5	85.0	10.36	5 300	6 300	0.750	-	-
130		25	1.5	1.5	88.5	-	NU215E	116.4	133.7	16.31	4 200	5 200	1.290	HJ215	0.165	
130		25	1.5	1.5	88.5	-	NJ215E	116.4	133.7	16.31	4 200	5 200	1.290	HJ215	0.165	
130		25	1.5	1.5	88.5	-	NUP215E	116.4	133.7	16.31	4 200	5 200	1.290	-	-	
130		25	1.5	1.5	-	118.5	N215E	122.2	142.7	17.40	4 200	5 200	1.290	-	-	
130		25	1.5	1.5	-	118.5	NF215E	116.4	133.7	16.31	4 200	5 200	1.290	-	-	
130		25	1.5	1.5	88.5	-	NU215ETNG	133.4	160.5	19.42	4 200	5 200	1.290	HJ215	0.165	
130		25	1.5	1.5	88.5	-	NJ215ETNG	133.4	160.5	19.42	4 200	5 200	1.290	HJ215	0.165	
130		25	1.5	1.5	88.5	-	NUP215ETNG	133.4	160.5	19.42	4 200	5 200	1.290	-	-	
130		25	1.5	1.5	-	118.5	N215ETNG	133.4	160.5	19.42	4 200	5 200	1.290	-	-	
130		25	1.5	1.5	-	118.5	NF215ETNG	133.4	160.5	19.42	4 200	5 200	1.290	-	-	
130		25	1.5	1.5	88.5	-	NU215EM	121.5	142.7	17.27	4 200	5 200	1.290	HJ215	0.165	
130		25	1.5	1.5	88.5	-	NJ215EM	121.5	142.7	17.27	4 200	5 200	1.290	HJ215	0.165	
130		25	1.5	1.5	88.5	-	NUP215EM	121.5	142.7	17.27	4 200	5 200	1.290	-	-	
130		25	1.5	1.5	-	118.5	N215EM	121.5	142.7	17.27	4 200	5 200	1.290	-	-	

Single Row Cylindrical Roller Bearings

d = 75 mm

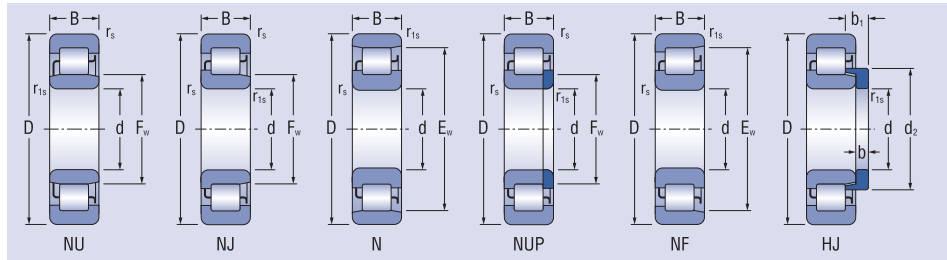

Dimensions							Bearing designation	Basic load rating		Fatigue load limit	Limiting speed for lubrication with		Mass of Bearings	Separate Thrust Collar	Mass of separate Thrust Collar
d	D	B	r _s min	r _{s1} min	F _w	E _w		C _r	C _{0r}		grease	oil			
mm							kN			min ⁻¹					

75	130	25	1.5	1.5	-	118.5	NF215EM	121.5	142.7	17.27	4 200	5 200	1.290	-	-
	130	25	1.5	1.5	88.5	-	NU215EM1	133.4	160.5	19.42	4 200	5 200	1.290	HJ215	0.165
	130	25	1.5	1.5	88.5	-	NJ215EM1	133.4	160.5	19.42	4 200	5 200	1.290	HJ215	0.165
	130	25	1.5	1.5	-	118.5	NUP215EM1	133.4	160.5	19.42	4 200	5 200	1.290	-	-
	130	25	1.5	1.5	-	118.5	N215EM1	133.4	160.5	19.42	4 200	5 200	1.290	-	-
	130	25	1.5	1.5	-	118.5	NF215EM1	133.4	160.5	19.42	4 200	5 200	1.290	-	-
	130	31	1.5	1.5	88.5	-	NU2215E	143.3	174.6	21.13	4 200	5 200	1.640	HJ2215	0.167
	130	31	1.5	1.5	88.5	-	NJ2215E	143.3	174.6	21.13	4 200	5 200	1.640	HJ2215	0.167
	130	31	1.5	1.5	88.5	-	NUP2215E	143.3	174.6	21.13	4 200	5 200	1.640	-	-
	130	31	1.5	1.5	-	118.5	N2215E	143.3	174.6	21.13	4 200	5 200	1.640	-	-
	130	31	1.5	1.5	-	118.5	NF2215E	143.3	174.6	21.13	4 200	5 200	1.640	-	-
	130	31	1.5	1.5	88.5	-	NU2215ETNG	164.3	211.3	25.58	4 200	5 200	1.640	HJ2215	0.167
	130	31	1.5	1.5	88.5	-	NJ2215ETNG	164.3	211.3	25.58	4 200	5 200	1.640	HJ2215	0.167
	130	31	1.5	1.5	88.5	-	NUP2215ETNG	164.3	211.3	25.58	4 200	5 200	1.640	-	-
	130	31	1.5	1.5	-	118.5	N2215ETNG	164.3	211.3	25.58	4 200	5 200	1.640	-	-
	130	31	1.5	1.5	-	118.5	NF2215ETNG	164.3	211.3	25.58	4 200	5 200	1.640	-	-
	130	31	1.5	1.5	88.5	-	NU2215EM	150.4	187.8	22.73	4 200	5 200	1.640	HJ2215	0.167
	130	31	1.5	1.5	88.5	-	NJ2215EM	150.4	187.8	22.73	4 200	5 200	1.640	HJ2215	0.167
	130	31	1.5	1.5	88.5	-	NUP2215EM	150.4	187.8	22.73	4 200	5 200	1.640	-	-
	130	31	1.5	1.5	-	118.5	N2215EM	150.4	187.8	22.73	4 200	5 200	1.640	-	-
	130	31	1.5	1.5	-	118.5	NF2215EM	150.4	187.8	22.73	4 200	5 200	1.640	-	-
	130	31	1.5	1.5	88.5	-	NU2215EM1	164.3	211.3	25.58	4 200	5 200	1.640	HJ2215	0.167
	130	31	1.5	1.5	88.5	-	NJ2215EM1	164.3	211.3	25.58	4 200	5 200	1.640	HJ2215	0.167
	130	31	1.5	1.5	88.5	-	NUP2215EM1	164.3	211.3	25.58	4 200	5 200	1.640	-	-
	130	31	1.5	1.5	-	118.5	N2215EM1	164.3	211.3	25.58	4 200	5 200	1.640	-	-
	130	31	1.5	1.5	-	118.5	NF2215EM1	164.3	211.3	25.58	4 200	5 200	1.640	-	-
	160	37	2.1	2.1	95	-	NU315E	214.7	226.3	26.29	3 600	4 400	3.340	HJ315	0.410
	160	37	2.1	2.1	95	-	NJ315E	214.7	226.3	26.29	3 600	4 400	3.340	HJ315	0.410
	160	37	2.1	2.1	95	-	NUP315E	214.7	226.3	26.29	3 600	4 400	3.340	-	-
	160	37	2.1	2.1	-	143	N315E	229.2	246.8	28.68	3 600	4 400	3.340	-	-
	160	37	2.1	2.1	-	143	NF315E	214.7	226.3	26.29	3 600	4 400	3.340	-	-
	160	37	2.1	2.1	95	-	NU315EM	229.2	246.8	28.68	3 600	4 400	3.340	HJ315	0.410
	160	37	2.1	2.1	95	-	NJ315EM	229.2	246.8	28.68	3 600	4 400	3.340	HJ315	0.410
	160	37	2.1	2.1	95	-	NUP315EM	229.2	246.8	28.68	3 600	4 400	3.340	-	-
	160	37	2.1	2.1	-	143	N315EM	229.2	246.8	28.68	3 600	4 400	3.340	-	-
	160	37	2.1	2.1	-	143	NF315EM	229.2	246.8	28.68	3 600	4 400	3.340	-	-
	160	37	2.1	2.1	95	-	NU315EM1	243.4	267.4	31.07	3 600	4 400	3.340	HJ315	0.410
	160	37	2.1	2.1	95	-	NJ315EM1	243.4	267.4	31.07	3 600	4 400	3.340	HJ315	0.410
	160	37	2.1	2.1	95	-	NUP315EM1	243.4	267.4	31.07	3 600	4 400	3.340	-	-
	160	37	2.1	2.1	-	143	N315EM1	243.4	267.4	31.07	3 600	4 400	3.340	-	-
	160	37	2.1	2.1	-	143	NF315EM1	243.4	267.4	31.07	3 600	4 400	3.340	-	-
	160	55	2.1	2.1	95	-	NU2315E	293.1	337.6	40.86	3 600	4 400	5.040	HJ2315	0.439

Single Row Cylindrical Roller Bearings

d = 75 - 80 mm

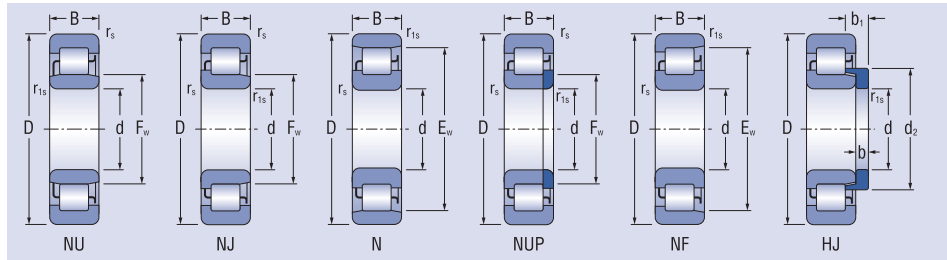

Dimensions							Bearing designation	Basic load rating		Fatigue load limit	Limiting speed for lubrication with		Mass of Bearings	Separate Thrust Collar	Mass of separate Thrust Collar
d	D	B	r _s min	r _{s1} min	F _w	E _w		C _r	C _{0r}		grease	oil			
mm							kN			min ⁻¹					
75	160	55	2.1	2.1	95	-	NJ2315E	293.1	337.6	40.86	3 600	4 400	5.040	HJ2315	0.439
	160	55	2.1	2.1	95	-	NUP2315E	293.1	337.6	40.86	3 600	4 400	5.040	-	-
	160	55	2.1	2.1	-	143	N2315E	312.9	368.2	44.57	3 600	4 400	5.040	-	-
	160	55	2.1	2.1	-	143	NF2315E	293.1	337.6	40.86	3 600	4 400	5.040	-	-
	160	55	2.1	2.1	95	-	NU2315EM	312.9	368.2	44.57	3 600	4 400	5.040	HJ2315	0.439
	160	55	2.1	2.1	95	-	NJ2315EM	312.9	368.2	44.57	3 600	4 400	5.040	HJ2315	0.439
	160	55	2.1	2.1	95	-	NUP2315EM	312.9	368.2	44.57	3 600	4 400	5.040	-	-
	160	55	2.1	2.1	-	143	N2315EM	312.9	368.2	44.57	3 600	4 400	5.040	-	-
	160	55	2.1	2.1	-	143	NF2315EM	312.9	368.2	44.57	3 600	4 400	5.040	-	-
	160	55	2.1	2.1	95	-	NU2315EM1	332.2	398.9	48.29	3 600	4 400	5.040	HJ2315	0.439
	160	55	2.1	2.1	95	-	NJ2315EM1	332.2	398.9	48.29	3 600	4 400	5.040	HJ2315	0.439
	160	55	2.1	2.1	95	-	NUP2315EM1	332.2	398.9	48.29	3 600	4 400	5.040	-	-
	160	55	2.1	2.1	-	143	N2315EM1	332.2	398.9	48.29	3 600	4 400	5.040	-	-
	160	55	2.1	2.1	-	143	NF2315EM1	332.2	398.9	48.29	3 600	4 400	5.040	-	-
	190	45	3.0	3.0	104.5	-	NU415EM	300.6	326.5	36.59	3 200	3 700	7.010	HJ415	0.710
	190	45	3.0	3.0	104.5	-	NJ415EM	300.6	326.5	36.59	3 200	3 700	7.010	HJ415	0.710
	190	45	3.0	3.0	104.5	-	NUP415EM	300.6	326.5	36.59	3 200	3 700	7.010	-	-
	190	45	3.0	3.0	-	160.5	N415EM	300.6	326.5	36.59	3 200	3 700	7.010	-	-
190	45	3.0	3.0	-	160.5	NF415EM	300.6	326.5	36.59	3 200	3 700	7.010	-	-	
80	125	22	1.1	1.0	91.5	-	NU1016EM	76.5	98.0	11.95	5 000	6 000	0.990	-	-
	125	22	1.1	1.0	91.5	-	NJ1016EM	76.5	98.0	11.95	5 000	6 000	0.990	-	-
	125	22	1.1	1.0	91.5	-	NUP1016EM	76.5	98.0	11.95	5 000	6 000	0.990	-	-
	140	26	2.1	2.1	95.3	-	NU216E	130.9	152.4	18.06	3 900	4 800	1.550	HJ216	0.222
	140	26	2.1	2.1	95.3	-	NJ216E	130.9	152.4	18.06	3 900	4 800	1.550	HJ216	0.222
	140	26	2.1	2.1	95.3	-	NUP216E	130.9	152.4	18.06	3 900	4 800	1.550	-	-
	140	26	2.1	2.1	-	127.3	N216E	136.6	161.9	19.75	3 900	4 800	1.550	-	-
	140	26	2.1	2.1	-	127.3	NF216E	130.9	152.4	18.06	3 900	4 800	1.550	-	-
	140	26	2.1	2.1	95.3	-	NU216ETNG	142.5	171.4	20.32	3 900	4 800	1.550	HJ216	0.222
	140	26	2.1	2.1	95.3	-	NJ216ETNG	142.5	171.4	20.32	3 900	4 800	1.550	HJ216	0.222
	140	26	2.1	2.1	95.3	-	NUP216ETNG	142.5	171.4	20.32	3 900	4 800	1.550	-	-
	140	26	2.1	2.1	-	127.3	N216ETNG	142.5	171.4	20.32	3 900	4 800	1.550	-	-
	140	26	2.1	2.1	-	127.3	NF216ETNG	142.5	171.4	20.32	3 900	4 800	1.550	-	-
	140	26	2.1	2.1	95.3	-	NU216EM1	142.5	171.4	20.32	3 900	4 800	1.550	HJ216	0.222
	140	26	2.1	2.1	95.3	-	NJ216EM1	142.5	171.4	20.32	3 900	4 800	1.550	HJ216	0.222
	140	26	2.1	2.1	95.3	-	NUP216EM1	142.5	171.4	20.32	3 900	4 800	1.550	-	-
	140	26	2.1	2.1	-	127.3	N216EM1	142.5	171.4	20.32	3 900	4 800	1.550	-	-
	140	26	2.1	2.1	-	127.3	NF216EM1	142.5	171.4	20.32	3 900	4 800	1.550	-	-
	140	33	2.1	2.1	95.3	-	NU2216E	173.0	219.9	26.06	3 900	4 800	2.050	HJ216	0.222
	140	33	2.1	2.1	95.3	-	NJ2216E	173.0	219.9	26.06	3 900	4 800	2.050	HJ216	0.222
	140	33	2.1	2.1	95.3	-	NUP2216E	173.0	219.9	26.06	3 900	4 800	2.050	-	-
	140	33	2.1	2.1	-	127.3	N2216E	173.0	219.9	26.06	3 900	4 800	2.050	-	-
	140	33	2.1	2.1	-	127.3	NF2216E	173.0	219.9	26.06	3 900	4 800	2.050	-	-

Single Row Cylindrical Roller Bearings

d = 80 mm

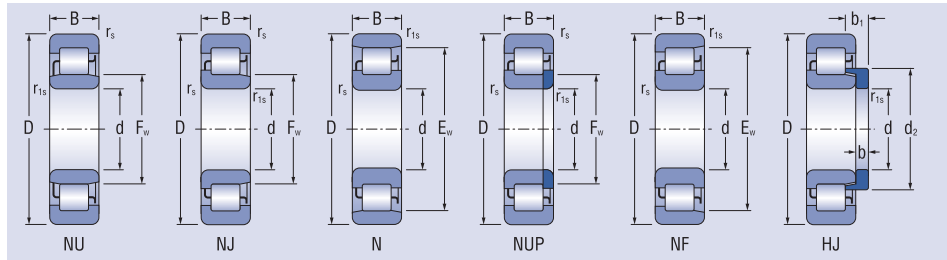

Dimensions							Bearing designation	Basic load rating		Fatigue load limit	Limiting speed		Mass of Bearings	Separate Thrust Collar	Mass of separate Thrust Collar
d	D	B	r _s min	r _{s1} min	F _w	E _w		C _r	C _{0r}		grease	oil			
mm							kN			min ⁻¹					
80	140	33	2.1	2.1	95.3	-	NU2216ETNG	189.0	247.4	29.32	3 900	4 800	2.050	HJ2216	0.222
	140	33	2.1	2.1	95.3	-	NJ2216ETNG	189.0	247.4	29.32	3 900	4 800	2.050	HJ2216	0.222
	140	33	2.1	2.1	95.3	-	NUP2216ETNG	189.0	247.4	29.32	3 900	4 800	2.050	-	-
	140	33	2.1	2.1	-	127.3	N2216ETNG	189.0	247.4	29.32	3 900	4 800	2.050	-	-
	140	33	2.1	2.1	-	127.3	NF2216ETNG	189.0	247.4	29.32	3 900	4 800	2.050	-	-
	140	33	2.1	2.1	95.3	-	NU2216EM	173.0	219.9	26.06	3 900	4 800	2.050	HJ2216	0.222
	140	33	2.1	2.1	95.3	-	NJ2216EM	173.0	219.9	26.06	3 900	4 800	2.050	HJ2216	0.222
	140	33	2.1	2.1	95.3	-	NUP2216EM	173.0	219.9	26.06	3 900	4 800	2.050	-	-
	140	33	2.1	2.1	-	127.3	N2216EM	173.0	219.9	26.06	3 900	4 800	2.050	-	-
	140	33	2.1	2.1	-	127.3	NF2216EM	173.0	219.9	26.06	3 900	4 800	2.050	-	-
	140	33	2.1	2.1	95.3	-	NU2216EM1	189.0	247.4	29.32	3 900	4 800	2.050	HJ2216	0.222
	140	33	2.1	2.1	95.3	-	NJ2216EM1	189.0	247.4	29.32	3 900	4 800	2.050	HJ2216	0.222
	140	33	2.1	2.1	95.3	-	NUP2216EM1	189.0	247.4	29.32	3 900	4 800	2.050	-	-
	140	33	2.1	2.1	-	127.3	N2216EM1	189.0	247.4	29.32	3 900	4 800	2.050	-	-
	140	33	2.1	2.1	-	127.3	NF2216EM1	189.0	247.4	29.32	3 900	4 800	2.050	-	-
	170	39	2.1	2.1	101	-	NU316E	231.5	246.4	28.10	3 400	4 100	4.120	HJ316	0.461
	170	39	2.1	2.1	101	-	NJ316E	231.5	246.4	28.10	3 400	4 100	4.120	HJ316	0.461
	170	39	2.1	2.1	101	-	NUP316E	231.5	246.4	28.10	3 400	4 100	4.120	-	-
	170	39	2.1	2.1	-	151	N316E	247.1	268.8	30.65	3 400	4 100	4.120	-	-
	170	39	2.1	2.1	-	151	NF316E	231.5	246.4	28.10	3 400	4 100	4.120	-	-
	170	39	2.1	2.1	101	-	NU316EM	247.1	268.8	30.65	3 400	4 100	4.120	HJ316	0.461
	170	39	2.1	2.1	101	-	NJ316EM	247.1	268.8	30.65	3 400	4 100	4.120	HJ316	0.461
	170	39	2.1	2.1	101	-	NUP316EM	247.1	268.8	30.65	3 400	4 100	4.120	-	-
	170	39	2.1	2.1	-	151	N316EM	247.1	268.8	30.65	3 400	4 100	4.120	-	-
	170	39	2.1	2.1	-	151	NF316EM	247.1	268.8	30.65	3 400	4 100	4.120	-	-
	170	39	2.1	2.1	101	-	NU316EM1	262.4	291.2	33.21	3 400	4 100	4.120	HJ316	0.461
	170	39	2.1	2.1	101	-	NJ316EM1	262.4	291.2	33.21	3 400	4 100	4.120	HJ316	0.461
	170	39	2.1	2.1	101	-	NUP316EM1	262.4	291.2	33.21	3 400	4 100	4.120	-	-
	170	39	2.1	2.1	-	151	N316EM1	262.4	291.2	33.21	3 400	4 100	4.120	-	-
	170	39	2.1	2.1	-	151	NF316EM1	262.4	291.2	33.21	3 400	4 100	4.120	-	-
	170	58	2.1	2.1	101	-	NU2316E	319.2	372.5	44.14	3 400	4 100	6.000	HJ2316	0.494
	170	58	2.1	2.1	101	-	NJ2316E	319.2	372.5	44.14	3 400	4 100	6.000	HJ2316	0.494
	170	58	2.1	2.1	101	-	NUP2316E	319.2	372.5	44.14	3 400	4 100	6.000	-	-
	170	58	2.1	2.1	-	151	N2316E	319.2	372.5	44.14	3 400	4 100	6.000	-	-
	170	58	2.1	2.1	-	151	NF2316E	319.2	372.5	44.14	3 400	4 100	6.000	-	-
	170	58	2.1	2.1	101	-	NU2316EM	340.8	406.3	48.15	3 400	4 100	6.000	HJ2316	0.494
	170	58	2.1	2.1	101	-	NJ2316EM	340.8	406.3	48.15	3 400	4 100	6.000	HJ2316	0.494
	170	58	2.1	2.1	101	-	NUP2316EM	340.8	406.3	48.15	3 400	4 100	6.000	-	-
	170	58	2.1	2.1	-	151	N2316EM	340.8	406.3	48.15	3 400	4 100	6.000	-	-
	170	58	2.1	2.1	-	151	NF2316EM	340.8	406.3	48.15	3 400	4 100	6.000	-	-
	170	58	2.1	2.1	101	-	NU2316EM1	361.8	440.2	52.17	3 400	4 100	6.000	HJ2316	0.494
	170	58	2.1	2.1	101	-	NJ2316EM1	361.8	440.2	52.17	3 400	4 100	6.000	HJ2316	0.494

Single Row Cylindrical Roller Bearings

d = 80 - 85 mm

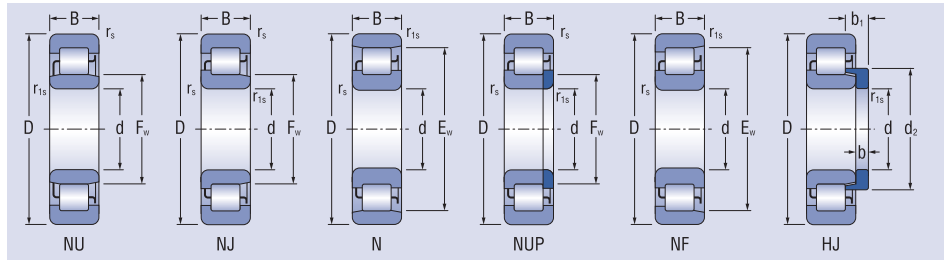

Dimensions							Bearing designation	Basic load rating		Fatigue load limit	Limiting speed for lubrication with		Mass of Bearings	Separate Thrust Collar	Mass of separate Thrust Collar
d	D	B	r _s min	r _{s1} min	F _w	E _w		C _r	C _{0r}		grease	oil			
mm							kN			min ⁻¹					
80	170	58	2.1	2.1	101	-	NUP2316EM1	361.8	440.2	52.17	3 400	4 100	6.000	-	-
	170	58	2.1	2.1	-	151	N2316EM1	361.8	440.2	52.17	3 400	4 100	6.000	-	-
	170	58	2.1	2.1	-	151	NF2316EM1	361.8	440.2	52.17	3 400	4 100	6.000	-	-
	200	48	3.0	3.0	110	-	NU416EM	323.1	348.5	38.41	3 000	3 500	8.110	HJ416	0.800
	200	48	3.0	3.0	110	-	NJ416EM	323.1	348.5	38.41	3 000	3 500	8.110	HJ416	0.800
	200	48	3.0	3.0	110	-	NUP416EM	323.1	348.5	38.41	3 000	3 500	8.110	-	-
	200	48	3.0	3.0	-	170	N416EM	323.1	348.5	38.41	3 000	3 500	8.110	-	-
	200	48	3.0	3.0	-	170	NF416EM	323.1	348.5	38.41	3 000	3 500	8.110	-	-
85	130	22	1.1	1.0	96.5	-	NU1017EM	78.0	104.0	12.41	4 700	5 600	1.050	-	-
	130	22	1.1	1.0	96.5	-	NJ1017EM	78.0	104.0	12.41	4 700	5 600	1.050	-	-
	130	22	1.1	1.0	96.5	-	NUP1017EM	78.0	104.0	12.41	4 700	5 600	1.050	-	-
	150	28	2.1	2.1	100.5	-	NU217E	153.6	177.3	20.60	3 600	4 400	1.920	HJ217	0.249
	150	28	2.1	2.1	100.5	-	NJ217E	153.6	177.3	20.60	3 600	4 400	1.920	HJ217	0.249
	150	28	2.1	2.1	100.5	-	NUP217E	153.6	177.3	20.60	3 600	4 400	1.920	-	-
	150	28	2.1	2.1	-	136.5	N217E	161.5	189.2	23.03	3 600	4 400	1.920	-	-
	150	28	2.1	2.1	-	136.5	NF217E	153.6	177.3	20.60	3 600	4 400	1.920	-	-
	150	28	2.1	2.1	100.5	-	NU217ETNG	169.0	200.97	23.35	3 600	4 400	1.920	HJ217	0.249
	150	28	2.1	2.1	100.5	-	NJ217ETNG	169.0	200.97	23.35	3 600	4 400	1.920	HJ217	0.249
	150	28	2.1	2.1	100.5	-	NUP217ETNG	169.0	200.97	23.35	3 600	4 400	1.920	-	-
	150	28	2.1	2.1	-	136.5	N217ETNG	169.0	200.97	23.35	3 600	4 400	1.920	-	-
	150	28	2.1	2.1	-	136.5	NF217ETNG	169.0	200.97	23.35	3 600	4 400	1.920	-	-
	150	28	2.1	2.1	100.5	-	NU217EM	161.2	189.2	21.98	3 600	4 400	1.920	HJ217	0.249
	150	28	2.1	2.1	100.5	-	NJ217EM	161.2	189.2	21.98	3 600	4 400	1.920	HJ217	0.249
	150	28	2.1	2.1	100.5	-	NUP217EM	161.2	189.2	21.98	3 600	4 400	1.920	-	-
	150	28	2.1	2.1	-	136.5	N217EM	161.2	189.2	21.98	3 600	4 400	1.920	-	-
	150	28	2.1	2.1	-	136.5	NF217EM	161.2	189.2	21.98	3 600	4 400	1.920	-	-
	150	28	2.1	2.1	100.5	-	NU217EM1	169.0	200.97	23.35	3 600	4 400	1.920	HJ217	0.249
	150	28	2.1	2.1	100.5	-	NJ217EM1	169.0	200.97	23.35	3 600	4 400	1.920	HJ217	0.249
	150	28	2.1	2.1	100.5	-	NUP217EM1	169.0	200.97	23.35	3 600	4 400	1.920	-	-
	150	28	2.1	2.1	-	136.5	N217EM1	169.0	200.97	23.35	3 600	4 400	1.920	-	-
	150	28	2.1	2.1	-	136.5	NF217EM1	169.0	200.97	23.35	3 600	4 400	1.920	-	-
	150	36	2.1	2.1	100.5	-	NU2217ETNG	219.4	277.7	32.79	3 600	4 400	2.550	HJ2217	0.250
	150	36	2.1	2.1	100.5	-	NJ2217ETNG	219.4	277.7	32.79	3 600	4 400	2.550	HJ2217	0.250
	150	36	2.1	2.1	100.5	-	NUP2217ETNG	219.4	277.7	32.79	3 600	4 400	2.550	-	-
	150	36	2.1	2.1	-	136.5	N2217ETNG	219.4	277.7	32.79	3 600	4 400	2.550	-	-
	150	36	2.1	2.1	-	136.5	NF2217ETNG	219.4	277.7	32.79	3 600	4 400	2.550	-	-
	150	36	2.1	2.1	100.5	-	NU2217EM1	219.4	277.7	32.79	3 600	4 400	2.550	HJ2217	0.250
	150	36	2.1	2.1	100.5	-	NJ2217EM1	219.4	277.7	32.79	3 600	4 400	2.550	HJ2217	0.250
	150	36	2.1	2.1	100.5	-	NUP2217EM1	219.4	277.7	32.79	3 600	4 400	2.550	-	-
	150	36	2.1	2.1	-	136.5	N2217EM1	219.4	277.7	32.79	3 600	4 400	2.550	-	-
150	36	2.1	2.1	-	136.5	NF2217EM1	219.4	277.7	32.79	3 600	4 400	2.550	-	-	

Single Row Cylindrical Roller Bearings

d = 85 - 90 mm

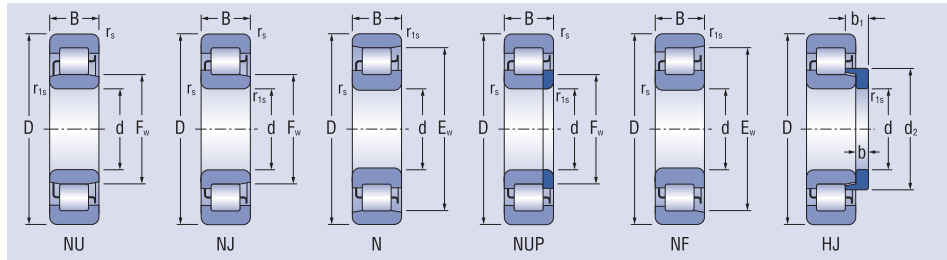

Dimensions							Bearing designation	Basic load rating		Fatigue load limit	Limiting speed for lubrication with		Mass of Bearings	Separate Thrust Collar	Mass of separate Thrust Collar
d	D	B	r _s min	r _{s1} min	F _w	E _w		C _r	C _{0r}		grease	oil			
mm							kN			min ⁻¹					
85	180	41	3.0	3.0	108	-	NU317E	249.1	267.8	30.01	3 100	3 900	5.300	HJ317	0.566
	180	41	3.0	3.0	108	-	NJ317E	249.1	267.8	30.01	3 100	3 900	5.300	HJ317	0.566
	180	41	3.0	3.0	108	-	NUP317E	249.1	267.8	30.01	3 100	3 900	5.300	-	-
	180	41	3.0	3.0	-	160	N317E	265.9	292.1	34.81	3 100	3 900	5.300	-	-
	180	41	3.0	3.0	-	160	NF317E	249.1	267.8	30.01	3 100	3 900	5.300	-	-
	180	41	3.0	3.0	108	-	NU317EM	282.3	316.4	35.47	3 100	3 900	5.300	HJ317	0.566
	180	41	3.0	3.0	108	-	NJ317EM	282.3	316.4	35.47	3 100	3 900	5.300	HJ317	0.566
	180	41	3.0	3.0	108	-	NUP317EM	282.3	316.4	35.47	3 100	3 900	5.300	-	-
	180	41	3.0	3.0	-	160	N317EM	282.3	316.4	35.47	3 100	3 900	5.300	-	-
	180	41	3.0	3.0	-	160	NF317EM	282.3	316.4	35.47	3 100	3 900	5.300	-	-
	180	60	3.0	3.0	108	-	NU2317EM	377.8	460.3	51.59	3 100	3 900	6.710	HJ2317	0.606
	180	60	3.0	3.0	108	-	NJ2317EM	377.8	460.3	51.59	3 100	3 900	6.710	HJ2317	0.606
	180	60	3.0	3.0	108	-	NUP2317EM	377.8	460.3	51.59	3 100	3 900	6.710	-	-
	180	60	3.0	3.0	-	160	N2317EM	377.8	460.3	51.59	3 100	3 900	6.710	-	-
	180	60	3.0	3.0	-	160	NF2317EM	377.8	460.3	51.59	3 100	3 900	6.710	-	-
	210	52	4.0	4.0	115.5	-	NU417EM	365.0	397.0	43.08	2 800	3 300	9.620	HJ417	0.890
	210	52	4.0	4.0	115.5	-	NJ417EM	365.0	397.0	43.08	2 800	3 300	9.620	HJ417	0.890
	210	52	4.0	4.0	115.5	-	NUP417EM	365.0	397.0	43.08	2 800	3 300	9.620	-	-
210	52	4.0	4.0	-	179.5	N417EM	365.0	397.0	43.08	2 800	3 300	9.620	-	-	
210	52	4.0	4.0	-	179.5	NF417EM	365.0	397.0	43.08	2 800	3 300	9.620	-	-	
90	140	24	1.5	1.1	103	-	NU1018EM	93.0	125.0	14.61	4 500	5 300	1.310	-	-
	140	24	1.5	1.1	103	-	NJ1018EM	93.0	125.0	14.61	4 500	5 300	1.310	-	-
	140	24	1.5	1.1	103	-	NUP1018EM	93.0	125.0	14.61	4 500	5 300	1.310	-	-
	160	30	2.1	2.1	107	-	NU218E	170.2	206.9	23.59	3 400	4 100	2.370	HJ218	0.316
	160	30	2.1	2.1	107	-	NJ218E	170.2	206.9	23.59	3 400	4 100	2.370	HJ218	0.316
	160	30	2.1	2.1	107	-	NUP218E	170.2	206.9	23.59	3 400	4 100	2.370	-	-
	160	30	2.1	2.1	-	145	N218E	178.2	211.3	25.60	3 400	4 100	2.370	-	-
	160	30	2.1	2.1	-	145	NF218E	170.2	206.9	23.59	3 400	4 100	2.370	-	-
	160	30	2.1	2.1	107	-	NU218ETNG	187.0	224.5	25.60	3 400	4 100	2.370	HJ218	0.316
	160	30	2.1	2.1	107	-	NJ218ETNG	187.0	224.5	25.60	3 400	4 100	2.370	HJ218	0.316
	160	30	2.1	2.1	107	-	NUP218ETNG	187.0	224.5	25.60	3 400	4 100	2.370	-	-
	160	30	2.1	2.1	-	145	N218ETNG	187.0	224.5	25.60	3 400	4 100	2.370	-	-
	160	30	2.1	2.1	-	145	NF218ETNG	187.0	224.5	25.60	3 400	4 100	2.370	-	-
	160	30	2.1	2.1	107	-	NU218EM	178.2	211.3	24.10	3 400	4 100	2.370	HJ218	0.316
	160	30	2.1	2.1	107	-	NJ218EM	178.2	211.3	24.10	3 400	4 100	2.370	HJ218	0.316
	160	30	2.1	2.1	107	-	NUP218EM	178.2	211.3	24.10	3 400	4 100	2.370	-	-
	160	30	2.1	2.1	-	145	N218EM	178.2	211.3	24.10	3 400	4 100	2.370	-	-
	160	30	2.1	2.1	-	145	NF218EM	178.2	211.3	24.10	3 400	4 100	2.370	-	-
	160	30	2.1	2.1	107	-	NU218EM1	187.0	224.5	25.60	3 400	4 100	2.370	HJ218	0.316
	160	30	2.1	2.1	107	-	NJ218EM1	187.0	224.5	25.60	3 400	4 100	2.370	HJ218	0.316
	160	30	2.1	2.1	107	-	NUP218EM1	187.0	224.5	25.60	3 400	4 100	2.370	-	-

Single Row Cylindrical Roller Bearings

d = 90 - 95 mm

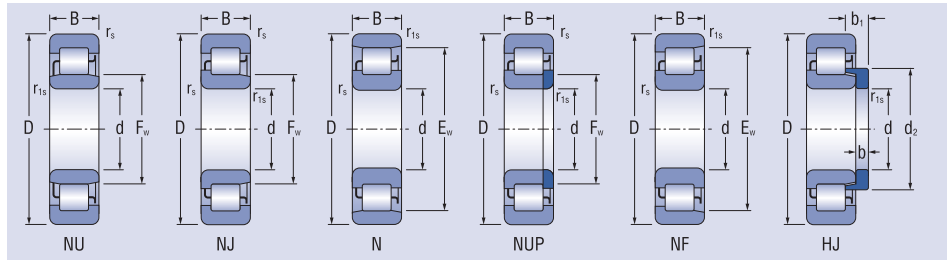

Dimensions							Bearing designation	Basic load rating		Fatigue load limit	Limiting speed		Mass of Bearings	Separate Thrust Collar	Mass of separate Thrust Collar	
d	D	B	r _s min	r _{s1} min	F _w	E _w		C _r	C _{0r}		grease	oil				
mm							kN			min ⁻¹						
90	160	30	2.1	2.1	-	145	N218EM1	187.0	224.5	25.60	3 400	4 100	2.370	-	-	
	160	30	2.1	2.1	-	145	NF218EM1	187.0	224.5	25.60	3 400	4 100	2.370	-	-	
	160	40	2.1	2.1	107	-	NU2218ETNG	246.3	321.0	37.30	3 400	4 100	3.230	HJ2218	0.328	
	160	40	2.1	2.1	107	-	NJ2218ETNG	246.3	321.0	37.30	3 400	4 100	3.230	HJ2218	0.328	
	160	40	2.1	2.1	107	-	NUP2218ETNG	246.3	321.0	37.30	3 400	4 100	3.230	-	-	
	160	40	2.1	2.1	-	145	N2218ETNG	246.3	321.0	37.30	3 400	4 100	3.230	-	-	
	160	40	2.1	2.1	-	145	NF2218ETNG	246.3	321.0	37.30	3 400	4 100	3.230	-	-	
	160	40	2.1	2.1	107	-	NU2218EM	235.3	302.1	35.11	3 400	4 100	3.230	HJ2218	0.328	
	160	40	2.1	2.1	107	-	NJ2218EM	235.3	302.1	35.11	3 400	4 100	3.230	HJ2218	0.328	
	160	40	2.1	2.1	107	-	NUP2218EM	235.3	302.1	35.11	3 400	4 100	3.230	-	-	
	160	40	2.1	2.1	-	145	N2218EM	235.3	302.1	35.11	3 400	4 100	3.230	-	-	
	160	40	2.1	2.1	-	145	NF2218EM	235.3	302.1	35.11	3 400	4 100	3.230	-	-	
	160	40	2.1	2.1	107	-	NU2218EM1	246.3	321.0	37.30	3 400	4 100	3.230	HJ2218	0.328	
	160	40	2.1	2.1	107	-	NJ2218EM1	246.3	321.0	37.30	3 400	4 100	3.230	HJ2218	0.328	
	160	40	2.1	2.1	107	-	NUP2218EM1	246.3	321.0	37.30	3 400	4 100	3.230	-	-	
	160	40	2.1	2.1	-	145	N2218EM1	246.3	321.0	37.30	3 400	4 100	3.230	-	-	
	160	40	2.1	2.1	-	145	NF2218EM1	246.3	321.0	37.30	3 400	4 100	3.230	-	-	
	190	43	3.0	3.0	113.5	-	NU318E	282.0	304.4	33.55	2 900	3 600	6.190	HJ318	0.623	
	190	43	3.0	3.0	113.5	-	NJ318E	282.0	304.4	33.55	2 900	3 600	6.190	HJ318	0.623	
	190	43	3.0	3.0	113.5	-	NUP318E	282.0	304.4	33.55	2 900	3 600	6.190	-	-	
	190	43	3.0	3.0	-	169.5	N318E	301.0	332.0	38.98	2 900	3 600	6.190	-	-	
	190	43	3.0	3.0	-	169.5	NF318E	282.0	304.4	33.55	2 900	3 600	6.190	-	-	
	190	43	3.0	3.0	113.5	-	NU318EM	319.7	359.7	39.66	2 900	3 600	6.190	HJ318	0.623	
	190	43	3.0	3.0	113.5	-	NJ318EM	319.7	359.7	39.66	2 900	3 600	6.190	HJ318	0.623	
	190	43	3.0	3.0	113.5	-	NUP318EM	319.7	359.7	39.66	2 900	3 600	6.190	-	-	
	190	43	3.0	3.0	-	169.5	N318EM	319.7	359.7	39.66	2 900	3 600	6.190	-	-	
	190	43	3.0	3.0	-	169.5	NF318EM	319.7	359.7	39.66	2 900	3 600	6.190	-	-	
	190	64	3.0	3.0	113.5	-	NU2318EM	438.2	539.6	61.54	2 900	3 600	8.040	HJ2318	0.669	
	190	64	3.0	3.0	113.5	-	NJ2318EM	438.2	539.6	61.54	2 900	3 600	8.040	HJ2318	0.669	
	190	64	3.0	3.0	113.5	-	NUP2318EM	438.2	539.6	61.54	2 900	3 600	8.040	-	-	
	190	64	3.0	3.0	-	169.5	N2318EM	438.2	539.6	61.54	2 900	3 600	8.040	-	-	
	190	64	3.0	3.0	-	169.5	NF2318EM	438.2	539.6	61.54	2 900	3 600	8.040	-	-	
225	54	4.0	4.0	123.5	-	NU418EM	409.6	450.5	47.93	2 600	3 100	11.790	HJ418	1.050		
225	54	4.0	4.0	123.5	-	NJ418EM	409.6	450.5	47.93	2 600	3 100	11.790	HJ418	1.050		
225	54	4.0	4.0	123.5	-	NUP418EM	409.6	450.5	47.93	2 600	3 100	11.790	-	-		
225	54	4.0	4.0	-	191.5	N418EM	409.6	450.5	47.93	2 600	3 100	11.790	-	-		
225	54	4.0	4.0	-	191.5	NF418EM	409.6	450.5	47.93	2 600	3 100	11.790	-	-		
95	145	24	1.5	1.1	108	-	NU1019EM1	96.5	129.0	14.89	4 200	5 000	1.420	-	-	
	145	24	1.5	1.1	108	-	NJ1019EM1	96.5	129.0	14.89	4 200	5 000	1.420	-	-	
	145	24	1.5	1.1	108	-	NUP1019EM1	96.5	129.0	14.89	4 200	5 000	1.420	-	-	
	170	32	2.1	2.1	112.5	-	NU219ETNG	224.1	270.0	30.27	3 100	3 900	2.890	HJ219	0.356	

Single Row Cylindrical Roller Bearings

d = 95 mm

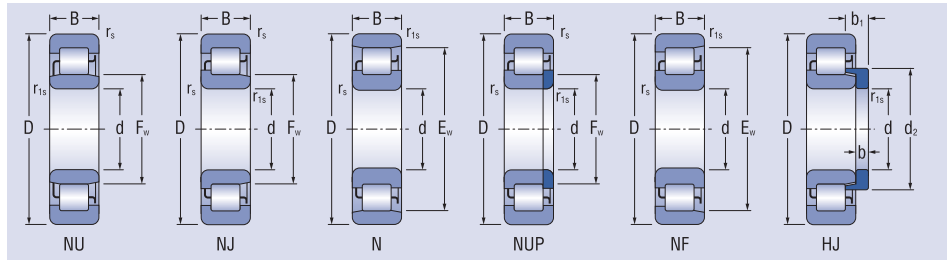

Dimensions							Bearing designation	Basic load rating		Fatigue load limit	Limiting speed for lubrication with		Mass of Bearings	Separate Thrust Collar	Mass of separate Thrust Collar
d	D	B	r _s min	r _{s1} min	F _w	E _w		C _r	C _{0r}		grease	oil			
mm							kN			min ⁻¹					
95	170	32	2.1	2.1	112.5	-	NJ219ETNG	224.1	270.0	30.27	3 100	3 900	2.890	HJ219	0.356
	170	32	2.1	2.1	112.5	-	NUP219ETNG	224.1	270.0	30.27	3 100	3 900	2.890	-	-
	170	32	2.1	2.1	-	154.5	N219ETNG	224.1	270.0	30.27	3 100	3 900	2.890	-	-
	170	32	2.1	2.1	-	154.5	NF219ETNG	224.1	270.0	30.27	3 100	3 900	2.890	-	-
	170	32	2.1	2.1	112.5	-	NU219EM	213.6	254.1	28.48	3 100	3 900	2.890	HJ219	0.356
	170	32	2.1	2.1	112.5	-	NJ219EM	213.6	254.1	28.48	3 100	3 900	2.890	HJ219	0.356
	170	32	2.1	2.1	112.5	-	NUP219EM	213.6	254.1	28.48	3 100	3 900	2.890	-	-
	170	32	2.1	2.1	-	154.5	N219EM	213.6	254.1	28.48	3 100	3 900	2.890	-	-
	170	32	2.1	2.1	-	154.5	NF219EM	213.6	254.1	28.48	3 100	3 900	2.890	-	-
	170	43	2.1	2.1	112.5	-	NU2219ETNG	291.0	378.6	43.18	3 100	3 900	3.980	HJ2219	0.362
	170	43	2.1	2.1	112.5	-	NJ2219ETNG	291.0	378.6	43.18	3 100	3 900	3.980	HJ2219	0.362
	170	43	2.1	2.1	112.5	-	NUP2219ETNG	291.0	378.6	43.18	3 100	3 900	3.980	-	-
	170	43	2.1	2.1	-	154.5	N2219ETNG	291.0	378.6	43.18	3 100	3 900	3.980	-	-
	170	43	2.1	2.1	-	154.5	NF2219ETNG	291.0	378.6	43.18	3 100	3 900	3.980	-	-
	170	43	2.1	2.1	112.5	-	NU2219EM	277.9	356.3	40.64	3 100	3 900	3.980	HJ2219	0.362
	170	43	2.1	2.1	112.5	-	NJ2219EM	277.9	356.3	40.64	3 100	3 900	3.980	HJ2219	0.362
	170	43	2.1	2.1	112.5	-	NUP2219EM	277.9	356.3	40.64	3 100	3 900	3.980	-	-
	170	43	2.1	2.1	-	154.5	N2219EM	277.9	356.3	40.64	3 100	3 900	3.980	-	-
	170	43	2.1	2.1	-	154.5	NF2219EM	277.9	356.3	40.64	3 100	3 900	3.980	-	-
	200	45	3.0	3.0	121.5	-	NU319E	301.4	336.4	36.51	2 800	3 400	7.040	HJ319	0.777
	200	45	3.0	3.0	121.5	-	NJ319E	301.4	336.4	36.51	2 800	3 400	7.040	HJ319	0.777
	200	45	3.0	3.0	121.5	-	NUP319E	301.4	336.4	36.51	2 800	3 400	7.040	-	-
	200	45	3.0	3.0	-	177.5	N319E	301.4	336.4	36.51	2 800	3 400	7.040	-	-
	200	45	3.0	3.0	-	177.5	NF319E	301.4	336.4	36.51	2 800	3 400	7.040	-	-
	200	45	3.0	3.0	121.5	-	NU319EM	320.0	364.5	39.55	2 800	3 400	7.040	HJ319	0.777
	200	45	3.0	3.0	121.5	-	NJ319EM	320.0	364.5	39.55	2 800	3 400	7.040	HJ319	0.777
	200	45	3.0	3.0	121.5	-	NUP319EM	320.0	364.5	39.55	2 800	3 400	7.040	-	-
	200	45	3.0	3.0	-	177.5	N319EM	320.0	364.5	39.55	2 800	3 400	7.040	-	-
	200	45	3.0	3.0	-	177.5	NF319EM	320.0	364.5	39.55	2 800	3 400	7.040	-	-
	200	67	3.0	3.0	121.5	-	NU2319EM	438.7	546.7	61.27	2 800	3 400	9.400	HJ2319	0.830
	200	67	3.0	3.0	121.5	-	NJ2319EM	438.7	546.7	61.27	2 800	3 400	9.400	HJ2319	0.830
	200	67	3.0	3.0	121.5	-	NUP2319EM	438.7	546.7	61.27	2 800	3 400	9.400	-	-
200	67	3.0	3.0	-	177.5	N2319EM	438.7	546.7	61.27	2 800	3 400	9.400	-	-	
200	67	3.0	3.0	-	177.5	NF2319EM	438.7	546.7	61.27	2 800	3 400	9.400	-	-	
240	55	4.0	4.0	133.5	-	NU419EM	411.0	457.9	47.83	2 400	2 900	13.570	HJ419	1.300	
240	55	4.0	4.0	133.5	-	NJ419EM	411.0	457.9	47.83	2 400	2 900	13.570	HJ419	1.300	
240	55	4.0	4.0	133.5	-	NUP419EM	411.0	457.9	47.83	2 400	2 900	13.570	-	-	
240	55	4.0	4.0	-	201.5	N419EM	411.0	457.9	47.83	2 400	2 900	13.570	-	-	
240	55	4.0	4.0	-	201.5	NF419EM	411.0	457.9	47.83	2 400	2 900	13.570	-	-	

Single Row Cylindrical Roller Bearings

d = 100 mm

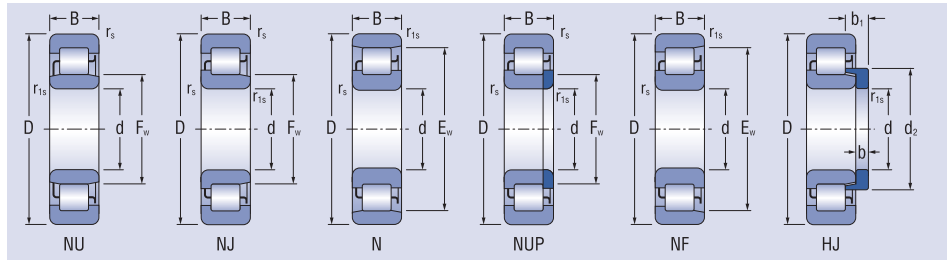

Dimensions							Bearing designation	Basic load rating		Fatigue load limit	Limiting speed for lubrication with		Mass of Bearings	Separate Thrust Collar	Mass of separate Thrust Collar
d	D	B	r _s min	r _{s1} min	F _w	E _w		C _r	C _{0r}		grease	oil			
mm							kN			min ⁻¹					
100	150	24	1.5	1.1	113	-	NU1020EM	98.0	134.0	15.28	3 800	4 800	1.480	-	-
	150	24	1.5	1.1	113	-	NJ1020EM	98.0	134.0	15.28	3 800	4 800	1.480	-	-
	150	24	1.5	1.1	113	-	NUP1020EM	98.0	134.0	15.28	3 800	4 800	1.480	-	-
	180	34	2.1	2.1	119	-	NU220ETNG	253.6	311.1	34.29	2 900	3 600	3.500	HJ220	0.436
	180	34	2.1	2.1	119	-	NJ220ETNG	253.6	311.1	34.29	2 900	3 600	3.500	HJ220	0.436
	180	34	2.1	2.1	119	-	NUP220ETNG	253.6	311.1	34.29	2 900	3 600	3.500	-	-
	180	34	2.1	2.1	-	163	N220ETNG	253.6	311.1	34.29	2 900	3 600	3.500	-	-
	180	34	2.1	2.1	-	163	NF220ETNG	253.6	311.1	34.29	2 900	3 600	3.500	-	-
	180	34	2.1	2.1	119	-	NU220EM	241.5	292.8	32.28	2 900	3 600	3.500	HJ220	0.436
	180	34	2.1	2.1	119	-	NJ220EM	241.5	292.8	32.28	2 900	3 600	3.500	HJ220	0.436
	180	34	2.1	2.1	119	-	NUP220EM	241.5	292.8	32.28	2 900	3 600	3.500	-	-
	180	34	2.1	2.1	-	163	N220EM	241.5	292.8	32.28	2 900	3 600	3.500	-	-
	180	34	2.1	2.1	-	163	NF220EM	241.5	292.8	32.28	2 900	3 600	3.500	-	-
	180	34	2.1	2.1	119	-	NU220EM1	250.0	305.0	33.55	2 900	3 600	3.500	HJ220	0.436
	180	34	2.1	2.1	119	-	NJ220EM1	250.0	305.0	33.55	2 900	3 600	3.500	HJ220	0.436
	180	34	2.1	2.1	119	-	NUP220EM1	250.0	305.0	33.55	2 900	3 600	3.500	-	-
	180	34	2.1	2.1	-	163	N220EM1	250.0	305.0	33.55	2 900	3 600	3.500	-	-
	180	34	2.1	2.1	-	163	NF220EM1	250.0	305.0	33.55	2 900	3 600	3.500	-	-
	180	46	2.1	2.1	119	-	NU2220ETNG	336.8	450.0	49.61	2 900	3 600	4.850	HJ2220	0.447
	180	46	2.1	2.1	119	-	NJ2220ETNG	336.8	450.0	49.61	2 900	3 600	4.850	HJ2220	0.447
	180	46	2.1	2.1	119	-	NUP2220ETNG	336.8	450.0	49.61	2 900	3 600	4.850	-	-
	180	46	2.1	2.1	-	163	N2220ETNG	336.8	450.0	49.61	2 900	3 600	4.850	-	-
	180	46	2.1	2.1	-	163	NF2220ETNG	336.8	450.0	49.61	2 900	3 600	4.850	-	-
	180	46	2.1	2.1	119	-	NU2220EM1	336.8	450.0	49.61	2 900	3 600	4.850	HJ2220	0.447
	180	46	2.1	2.1	119	-	NJ2220EM1	336.8	450.0	49.61	2 900	3 600	4.850	HJ2220	0.447
	180	46	2.1	2.1	119	-	NUP2220EM1	336.8	450.0	49.61	2 900	3 600	4.850	-	-
	180	46	2.1	2.1	-	163	N2220EM1	336.8	450.0	49.61	2 900	3 600	4.850	-	-
	180	46	2.1	2.1	-	163	NF2220EM1	336.8	450.0	49.61	2 900	3 600	4.850	-	-
	215	47	3.0	3.0	127.5	-	NU320E	343.5	371.4	39.52	2 600	3 200	8.750	HJ320	0.882
	215	47	3.0	3.0	127.5	-	NJ320E	343.5	371.4	39.52	2 600	3 200	8.750	HJ320	0.882
	215	47	3.0	3.0	127.5	-	NUP320E	343.5	371.4	39.52	2 600	3 200	8.750	-	-
	215	47	3.0	3.0	-	191.5	N320E	366.2	405.2	45.94	2 600	3 200	8.750	-	-
	215	47	3.0	3.0	-	191.5	NF320E	343.5	371.4	39.52	2 600	3 200	8.750	-	-
	215	47	3.0	3.0	127.5	-	NU320EM	389.2	439.0	46.71	2 600	3 200	8.750	HJ320	0.882
	215	47	3.0	3.0	127.5	-	NJ320EM	389.2	439.0	46.71	2 600	3 200	8.750	HJ320	0.882
	215	47	3.0	3.0	127.5	-	NUP320EM	389.2	439.0	46.71	2 600	3 200	8.750	-	-
	215	47	3.0	3.0	-	191.5	N320EM	389.2	439.0	46.71	2 600	3 200	8.750	-	-
	215	47	3.0	3.0	-	191.5	NF320EM	389.2	439.0	46.71	2 600	3 200	8.750	-	-
	215	73	3.0	3.0	127.5	-	NU2320EM	579.2	731.6	77.85	2 600	3 200	12.100	HJ2320	0.934
	215	73	3.0	3.0	127.5	-	NJ2320EM	579.2	731.6	77.85	2 600	3 200	12.100	HJ2320	0.934
215	73	3.0	3.0	127.5	-	NUP2320EM	579.2	731.6	77.85	2 600	3 200	12.100	-	-	
215	73	3.0	3.0	-	191.5	N2320EM	579.2	731.6	77.85	2 600	3 200	12.100	-	-	

Single Row Cylindrical Roller Bearings

d = 100 - 110 mm

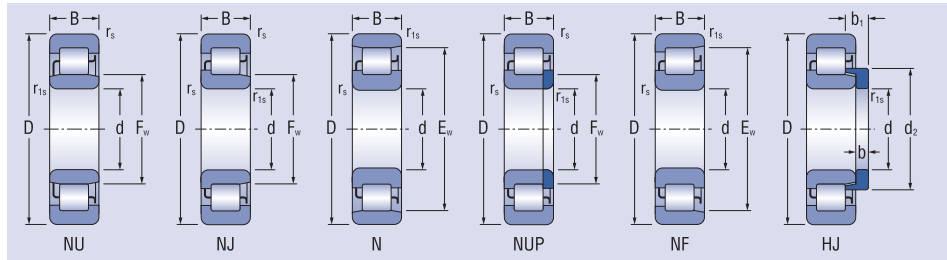

Dimensions							Bearing designation	Basic load rating		Fatigue load limit	Limiting speed for lubrication with		Mass of Bearings	Separate Thrust Collar	Mass of separate Thrust Collar
d	D	B	r _s min	r _{s1} min	F _w	E _w		C _r	C _{0r}		grease	oil			
mm							kN			min ⁻¹					
100	215	73	3.0	3.0	-	191.5	NF2320EM	579.2	731.6	77.85	2 600	3 200	12.100	-	-
	250	58	4.0	4.0	139	-	NU420EM	453.9	507.3	52.30	2 300	2 900	15.560	HJ420	1.550
	250	58	4.0	4.0	139	-	NJ420EM	453.9	507.3	52.30	2 300	2 900	15.560	HJ420	1.550
	250	58	4.0	4.0	139	-	NUP420EM	453.9	507.3	52.30	2 300	2 900	15.560	-	-
	250	58	4.0	4.0	-	211	N420EM	453.9	507.3	52.30	2 300	2 900	15.560	-	-
	250	58	4.0	4.0	-	211	NF420EM	453.9	507.3	52.30	2 300	2 900	15.560	-	-
105	160	26	2.0	1.1	119.5	-	NU1021EM	112.0	153.0	17.14	3 800	4 800	1.840	-	-
	160	26	2.0	1.1	119.5	-	NJ1021EM	112.0	153.0	17.14	3 800	4 800	1.840	-	-
	160	26	2.0	1.1	119.5	-	NUP1021EM	112.0	153.0	17.14	3 800	4 800	1.840	-	-
	190	36	2.1	2.1	125.5	-	NU221E	240.3	277.8	30.15	2 700	3 400	4.630	HJ221	0.510
	190	36	2.1	2.1	125.5	-	NJ221E	240.3	277.8	30.15	2 700	3 400	4.430	HJ221	0.510
	190	36	2.1	2.1	125.5	-	NUP221E	240.3	277.8	30.15	2 700	3 400	4.430	-	-
	190	36	2.1	2.1	-	171.5	N221E	240.3	277.8	30.15	2 700	3 400	4.430	-	-
	190	36	2.1	2.1	-	171.5	NF221E	240.3	277.8	30.15	2 700	3 400	4.430	-	-
	190	36	2.1	2.1	125.5	-	NU221ETNG	265.6	317.5	34.46	2 700	3 400	4.430	HJ221	0.510
	190	36	2.1	2.1	125.5	-	NJ221ETNG	265.6	317.5	34.46	2 700	3 400	4.430	HJ221	0.510
	190	36	2.1	2.1	125.5	-	NUP221ETNG	265.6	317.5	34.46	2 700	3 400	4.430	-	-
	190	36	2.1	2.1	-	171.5	N221ETNG	265.6	317.5	34.46	2 700	3 400	4.430	-	-
	190	36	2.1	2.1	-	171.5	NF221ETNG	265.6	317.5	34.46	2 700	3 400	4.430	-	-
	225	49	3.0	3.0	133	-	NU321EM	436.4	495.6	51.82	2 400	2 900	10.130	HJ321	1.050
	225	49	3.0	3.0	133	-	NJ321EM	436.4	495.6	51.82	2 400	2 900	10.130	HJ321	1.050
	225	49	3.0	3.0	133	-	NUP321EM	436.4	495.6	51.82	2 400	2 900	10.130	-	-
225	49	3.0	3.0	-	201	N321EM	436.4	495.6	51.82	2 400	2 900	10.130	-	-	
225	49	3.0	3.0	-	201	NF321EM	436.4	495.6	51.82	2 400	2 900	10.130	-	-	
110	170	28	2.0	1.1	125	-	NU1022EM	140.0	190.0	20.94	3 600	4 500	2.310	-	-
	170	28	2.0	1.1	125	-	NJ1022EM	140.0	190.0	20.94	3 600	4 500	2.310	-	-
	170	28	2.0	1.1	125	-	NUP1022EM	140.0	190.0	20.94	3 600	4 500	2.310	-	-
	200	38	2.1	2.1	132.5	-	NU222E	256.1	305.4	32.56	2 600	3 200	5.670	HJ222	0.617
	200	38	2.1	2.1	132.5	-	NJ222E	256.1	305.4	32.56	2 600	3 200	5.670	HJ222	0.617
	200	38	2.1	2.1	132.5	-	NUP222E	256.1	305.4	32.56	2 600	3 200	5.670	-	-
	200	38	2.1	2.1	-	180.5	N222E	256.1	305.4	32.56	2 600	3 200	5.670	-	-
	200	38	2.1	2.1	-	180.5	NF222E	256.1	305.4	32.56	2 600	3 200	5.670	-	-
	200	38	2.1	2.1	132.5	-	NU222ETNG	296.3	370.9	39.54	2 600	3 200	5.670	HJ222	0.617
	200	38	2.1	2.1	132.5	-	NJ222ETNG	296.3	370.9	39.54	2 600	3 200	5.670	HJ222	0.617
	200	38	2.1	2.1	132.5	-	NUP222ETNG	296.3	370.9	39.54	2 600	3 200	5.670	-	-
	200	38	2.1	2.1	-	180.5	N222ETNG	296.3	370.9	39.54	2 600	3 200	5.670	-	-
	200	38	2.1	2.1	-	180.5	NF222ETNG	296.3	370.9	39.54	2 600	3 200	5.670	-	-
	200	38	2.1	2.1	132.5	-	NU222EM	283.1	349.0	37.21	2 600	3 200	5.670	HJ222	0.617
	200	38	2.1	2.1	132.5	-	NJ222EM	283.1	349.0	37.21	2 600	3 200	5.670	HJ222	0.617
	200	38	2.1	2.1	132.5	-	NUP222EM	283.1	349.0	37.21	2 600	3 200	5.670	-	-
	200	38	2.1	2.1	-	180.5	N222EM	283.1	349.0	37.21	2 600	3 200	5.670	-	-
	200	38	2.1	2.1	-	180.5	NF222EM	283.1	349.0	37.21	2 600	3 200	5.670	-	-

Single Row Cylindrical Roller Bearings

d = 110 - 120 mm

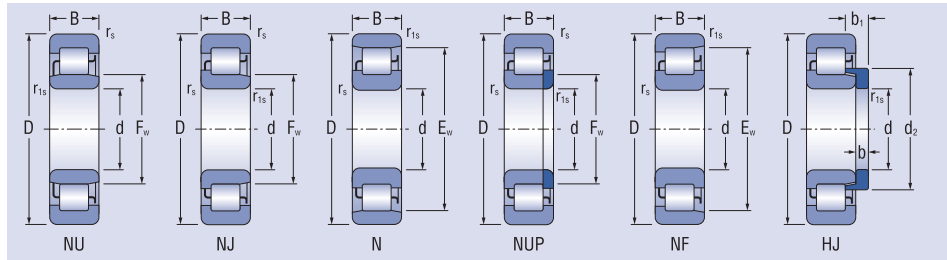

Dimensions							Bearing designation	Basic load rating		Fatigue load limit	Limiting speed for lubrication with		Mass of Bearings	Separate Thrust Collar	Mass of separate Thrust Collar
d	D	B	r _s min	r _{s1} min	F _w	E _w		C _r	C _{0r}		grease	oil			
mm							kN			min ⁻¹					
110	200	38	2.1	2.1	132.5	-	NU222EM1	296.3	370.9	39.54	2 600	3 200	5.670	HJ222	0.617
	200	38	2.1	2.1	132.5	-	NJ222EM1	296.3	370.9	39.54	2 600	3 200	5.670	HJ222	0.617
	200	38	2.1	2.1	132.5	-	NUP222EM1	296.3	370.9	39.54	2 600	3 200	5.670	-	-
	200	38	2.1	2.1	-	180.5	N222EM1	296.3	370.9	39.54	2 600	3 200	5.670	-	-
	200	38	2.1	2.1	-	180.5	NF222EM1	296.3	370.9	39.54	2 600	3 200	5.670	-	-
	200	53	2.1	2.1	132.5	-	NU2222EM	369.8	492.1	55.62	2 600	3 200	6.890	HJ2222	0.647
	200	53	2.1	2.1	132.5	-	NJ2222EM	369.8	492.1	55.62	2 600	3 200	6.890	HJ2222	0.647
	200	53	2.1	2.1	132.5	-	NUP2222EM	369.8	492.1	55.62	2 600	3 200	6.890	-	-
	200	53	2.1	2.1	-	180.5	N2222EM	369.8	492.1	55.62	2 600	3 200	6.890	-	-
	200	53	2.1	2.1	-	180.5	NF2222EM	369.8	492.1	55.62	2 600	3 200	6.890	-	-
	200	53	2.1	2.1	132.5	-	NU2222EM1	387.0	552.8	59.11	2 600	3 200	6.890	HJ2222	0.647
	200	53	2.1	2.1	132.5	-	NJ2222EM1	387.0	552.8	59.11	2 600	3 200	6.890	HJ2222	0.647
	200	53	2.1	2.1	132.5	-	NUP2222EM1	387.0	552.8	59.11	2 600	3 200	6.890	-	-
	200	53	2.1	2.1	-	180.5	N2222EM1	387.0	552.8	59.11	2 600	3 200	6.890	-	-
	200	53	2.1	2.1	-	180.5	NF2222EM1	387.0	552.8	59.11	2 600	3 200	6.890	-	-
	240	50	3.0	3.0	143	-	NU322EM	462.4	541.5	55.64	2 100	2 600	11.700	HJ322	1.210
	240	50	3.0	3.0	143	-	NJ322EM	462.4	541.5	55.64	2 100	2 600	11.700	HJ322	1.210
	240	50	3.0	3.0	143	-	NUP322EM	462.4	541.5	55.64	2 100	2 600	11.700	-	-
	240	50	3.0	3.0	-	211	N322EM	462.4	541.5	55.64	2 100	2 600	11.700	-	-
	240	50	3.0	3.0	-	211	NF322EM	462.4	541.5	55.64	2 100	2 600	11.700	-	-
	240	80	3.0	3.0	143	-	NU2322EM	647.6	832.7	85.86	2 100	2 600	17.000	HJ2322	1.250
	240	80	3.0	3.0	143	-	NJ2322EM	647.6	832.7	85.86	2 100	2 600	17.000	HJ2322	1.250
	240	80	3.0	3.0	143	-	NUP2322EM	647.6	832.7	85.86	2 100	2 600	17.000	-	-
	240	80	3.0	3.0	-	211	N2322EM	647.6	832.7	85.86	2 100	2 600	17.000	-	-
	240	80	3.0	3.0	-	211	NF2322EM	647.6	832.7	85.86	2 100	2 600	17.000	-	-
	280	65	4.0	4.0	155	-	NU422EM	554.7	631.2	63.00	2 200	2 700	21.880	HJ422	2.120
	280	65	4.0	4.0	155	-	NJ422EM	554.7	631.2	63.00	2 200	2 700	21.880	HJ422	2.120
	280	65	4.0	4.0	155	-	NUP422EM	554.7	631.2	63.00	2 200	2 700	21.880	-	-
280	65	4.0	4.0	-	235	N422EM	554.7	631.2	63.00	2 200	2 700	21.880	-	-	
280	65	4.0	4.0	-	235	NF422EM	554.7	631.2	63.00	2 200	2 700	21.880	-	-	
120	180	28	2.0	1.1	135	-	NU1024EM	150.0	208.0	22.46	3 300	4 000	2.470	-	-
	180	28	2.0	1.1	135	-	NJ1024EM	150.0	208.0	22.46	3 300	4 000	2.470	-	-
	180	28	2.0	1.1	135	-	NNUP1024EM	150.0	208.0	22.46	3 300	4 000	2.470	-	-
	215	40	2.1	2.1	143.5	-	NU224E	312.5	383.5	40.07	2 400	3 000	6.870	HJ224	0.708
	215	40	2.1	2.1	143.5	-	NJ224E	312.5	383.5	40.07	2 400	3 000	6.870	HJ224	0.708
	215	40	2.1	2.1	143.5	-	NUP224E	312.5	383.5	40.07	2 400	3 000	6.870	-	-
	215	40	2.1	2.1	-	195.5	N224E	312.5	383.5	40.07	2 400	3 000	6.870	-	-
	215	40	2.1	2.1	-	195.5	NF224E	312.5	383.5	40.07	2 400	3 000	6.870	-	-
	215	40	2.1	2.1	143.5	-	NU224ETNG	343.3	434.6	45.41	2 400	3 000	6.870	HJ224	0.708
	215	40	2.1	2.1	143.5	-	NJ224ETNG	343.3	434.6	45.41	2 400	3 000	6.870	HJ224	0.708
	215	40	2.1	2.1	143.5	-	NUP224ETNG	343.3	434.6	45.41	2 400	3 000	6.870	-	-
	215	40	2.1	2.1	-	195.5	N224ETNG	343.3	434.6	45.41	2 400	3 000	6.870	-	-

Single Row Cylindrical Roller Bearings

d = 120 - 130 mm

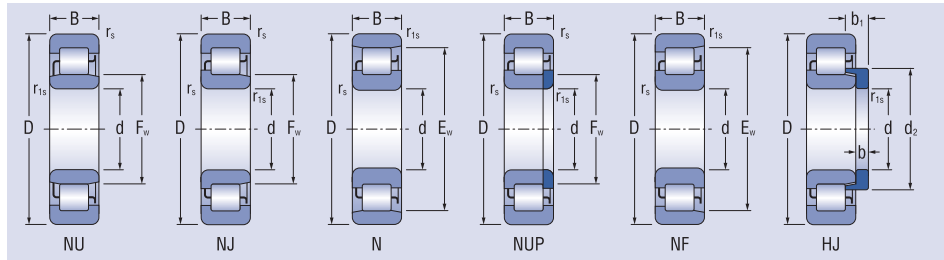

Dimensions							Bearing designation	Basic load rating		Fatigue load limit	Limiting speed		Mass of Bearings	Separate Thrust Collar	Mass of separate Thrust Collar
d	D	B	r _s min	r _{s1} min	F _w	E _w		C _r	C _{0r}		grease	oil			
mm							kN			min ⁻¹					
120	215	40	2.1	2.1	-	195.5	NF224ETNG	343.3	434.6	45.41	2 400	3 000	6.870	-	-
	215	40	2.1	2.1	143.5	-	NU224EM1	343.3	434.6	45.41	2 400	3 000	6.870	HJ224	0.708
	215	40	2.1	2.1	143.5	-	NJ224EM1	343.3	434.6	45.41	2 400	3 000	6.870	HJ224	0.708
	215	40	2.1	2.1	143.5	-	NUP224EM1	343.3	434.6	45.41	2 400	3 000	6.870	-	-
	215	40	2.1	2.1	-	195.5	N224EM1	343.3	434.6	45.41	2 400	3 000	6.870	-	-
	215	40	2.1	2.1	-	195.5	NF224EM1	343.3	434.6	45.41	2 400	3 000	6.870	-	-
	215	58	2.1	2.1	143.5	-	NU2224EM	439.0	595.1	62.16	2 200	3 000	8.540	HJ2224	0.751
	215	58	2.1	2.1	143.5	-	NJ2224EM	439.0	595.1	62.16	2 200	3 000	8.540	HJ2224	0.751
	215	58	2.1	2.1	143.5	-	NUP2224EM	439.0	595.1	62.16	2 200	3 000	8.540	-	-
	215	58	2.1	2.1	-	195.5	N2224EM	439.0	595.1	62.16	2 200	3 000	8.540	-	-
	215	58	2.1	2.1	-	195.5	NF2224EM	439.0	595.1	62.16	2 200	3 000	8.540	-	-
	215	58	2.1	2.1	143.5	-	NU2224EM1	450.1	615.8	64.33	2 200	3 000	8.540	HJ2224	0.751
	215	58	2.1	2.1	143.5	-	NJ2224EM1	450.1	615.8	64.33	2 200	3 000	8.540	HJ2224	0.751
	215	58	2.1	2.1	143.5	-	NUP2224EM1	450.1	615.8	64.33	2 200	3 000	8.540	-	-
	215	58	2.1	2.1	-	195.5	N2224EM1	450.1	615.8	64.33	2 200	3 000	8.540	-	-
	215	58	2.1	2.1	-	195.5	NF2224EM1	450.1	615.8	64.33	2 200	3 000	8.540	-	-
	260	55	3.0	3.0	154	-	NU324EM	535.0	620.6	62.24	1 900	2 400	14.900	HJ324	1.410
	260	55	3.0	3.0	154	-	NJ324EM	535.0	620.6	62.24	1 900	2 400	14.900	HJ324	1.410
	260	55	3.0	3.0	154	-	NUP324EM	535.0	620.6	62.24	1 900	2 400	14.900	-	-
	260	55	3.0	3.0	-	230	N324EM	535.0	620.6	62.24	1 900	2 400	14.900	-	-
	260	55	3.0	3.0	-	230	NF324EM	535.0	620.6	62.24	1 900	2 400	14.090	-	-
	260	86	3.0	3.0	154	-	NU2324EM	798.6	1 037.1	108.34	1 900	2 400	25.000	HJ2324	1.450
	260	86	3.0	3.0	154	-	NJ2324EM	798.6	1 037.1	108.34	1 900	2 400	25.000	HJ2324	1.450
	260	86	3.0	3.0	154	-	NUP2324EM	798.6	1 037.1	108.34	1 900	2 400	25.000	-	-
260	86	3.0	3.0	-	230	N2324EM	798.6	1 037.1	108.34	1 900	2 400	25.000	-	-	
260	86	3.0	3.0	-	230	NF2324EM	798.6	1 037.1	108.34	1 900	2 400	25.000	-	-	
130	200	33	2.0	1.1	148	-	NU1026EM	180.0	250.0	26.23	3 200	3 800	3.800	-	-
	200	33	2.0	1.1	148	-	NJ1026EM	180.0	250.0	26.23	3 200	3 800	3.800	-	-
	200	33	2.0	1.1	148	-	NUP1026EM	180.0	250.0	26.23	3 200	3 800	3.800	-	-
	230	40	3.0	3.0	153.5	-	NU226ETNG	371.7	467.6	47.81	2 200	2 800	7.010	HJ226	0.780
	230	40	3.0	3.0	153.5	-	NJ226ETNG	371.7	467.6	47.81	2 200	2 800	7.010	HJ226	0.780
	230	40	3.0	3.0	153.5	-	NUP226ETNG	371.7	467.6	47.81	2 200	2 800	7.010	-	-
	230	40	3.0	3.0	-	209.5	N226ETNG	371.7	467.6	47.81	2 200	2 800	7.010	-	-
	230	40	3.0	3.0	-	209.5	NF226ETNG	371.7	467.6	47.81	2 200	2 800	7.010	-	-
	230	40	3.0	3.0	153.5	-	NU226EM	351.0	433.5	44.31	2 200	2 800	7.010	HJ226	0.780
	230	40	3.0	3.0	153.5	-	NJ226EM	351.0	433.5	44.31	2 200	2 800	7.010	HJ226	0.780
	230	40	3.0	3.0	153.5	-	NUP226EM	351.0	433.5	44.31	2 200	2 800	7.010	-	-
	230	40	3.0	3.0	-	209.5	N226EM	351.0	433.5	44.31	2 200	2 800	7.010	-	-
	230	40	3.0	3.0	-	209.5	NF226EM	351.0	433.5	44.31	2 200	2 800	7.010	-	-
	230	64	3.0	3.0	153.5	-	NU2226EM	509.7	700.2	71.58	2 200	2 800	10.600	HJ2226	0.860
	230	64	3.0	3.0	153.5	-	NJ2226EM	509.7	700.2	71.58	2 200	2 800	10.600	HJ2226	0.860
	230	64	3.0	3.0	153.5	-	NUP2226EM	509.7	700.2	71.58	2 200	2 800	10.600	-	-

Single Row Cylindrical Roller Bearings

d = 130 - 150 mm

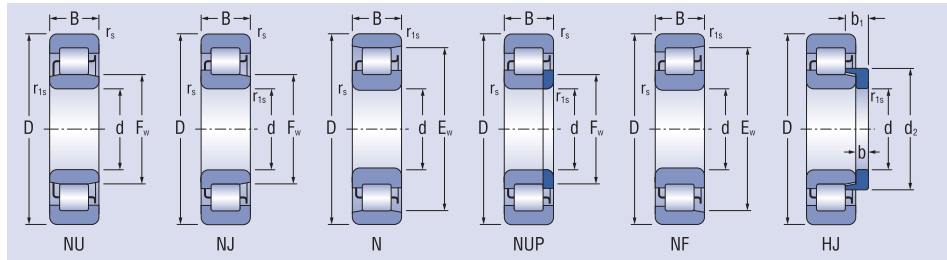

Dimensions							Bearing designation	Basic load rating		Fatigue load limit	Limiting speed for lubrication with		Mass of Bearings	Separate Thrust Collar	Mass of separate Thrust Collar	
d	D	B	r _s min	r _{s1} min	F _w	E _w		C _r	C _{0r}		grease	oil				kg
mm							kN			min ⁻¹						
130	230	64	3.0	3.0	-	209.5	N2226EM	509.7	700.2	71.58	2 200	2 800	10.600	-	-	
	230	64	3.0	3.0	-	209.5	NF2226EM	509.7	700.2	71.58	2 200	2 800	10.600	-	-	
	280	58	4.0	4.0	167	-	-	NU326EM	590.2	694.0	68.03	1 800	2 200	18.200	HJ326	1.640
	280	58	4.0	4.0	167	-	-	NJ326EM	590.2	694.0	68.03	1 800	2 200	18.200	HJ326	1.640
	280	58	4.0	4.0	167	-	-	NUP326EM	590.2	694.0	68.03	1 800	2 200	18.200	-	-
	280	58	4.0	4.0	-	247	-	N326EM	590.2	694.0	68.03	1 800	2 200	18.200	-	-
	280	58	4.0	4.0	-	247	-	NF326EM	590.2	694.0	68.03	1 800	2 200	18.200	-	-
140	210	33	2.0	1.1	158	-	NU1028EM	183.0	265.0	27.32	3 000	3 400	4.090	-	-	
	210	33	2.0	1.1	158	-	NJ1028EM	183.0	265.0	27.32	3 000	3 400	4.090	-	-	
	210	33	2.0	1.1	158	-	NUP1028EM	183.0	265.0	27.32	3 000	3 400	4.090	-	-	
	250	42	3.0	3.0	169	-	-	NU228E	369.7	473.5	47.26	2 000	2 600	9.290	HJ228	0.986
	250	42	3.0	3.0	169	-	-	NJ228E	369.7	473.5	47.26	2 000	2 600	9.290	HJ228	0.986
	250	42	3.0	3.0	169	-	-	NUP228E	369.7	473.5	47.26	2 000	2 600	9.290	-	-
	250	42	3.0	3.0	-	225	-	N228E	369.7	473.5	47.26	2 000	2 600	9.290	-	-
	250	42	3.0	3.0	-	225	-	NF228E	369.7	473.5	47.26	2 000	2 600	9.290	-	-
	250	42	3.0	3.0	169	-	-	NU228ETNG	386.9	503.1	50.21	2 000	2 600	9.290	HJ228	0.986
	250	42	3.0	3.0	169	-	-	NJ228ETNG	386.9	503.1	50.21	2 000	2 600	9.290	HJ228	0.986
	250	42	3.0	3.0	169	-	-	NUP228ETNG	386.9	503.1	50.21	2 000	2 600	9.290	-	-
	250	42	3.0	3.0	-	225	-	N228ETNG	386.9	503.1	50.21	2 000	2 600	9.290	-	-
	250	42	3.0	3.0	-	225	-	NF228ETNG	386.9	503.1	50.21	2 000	2 600	9.290	-	-
	250	42	3.0	3.0	169	-	-	NU228EM	386.9	503.1	50.21	2 000	2 600	9.290	HJ228	0.986
	250	42	3.0	3.0	169	-	-	NJ228EM	386.9	503.1	50.21	2 000	2 600	9.290	HJ228	0.986
	250	42	3.0	3.0	169	-	-	NUP228EM	386.9	503.1	50.21	2 000	2 600	9.290	-	-
	250	42	3.0	3.0	-	225	-	N228EM	386.9	503.1	50.21	2 000	2 600	9.290	-	-
	250	42	3.0	3.0	-	225	-	NF228EM	386.9	503.1	50.21	2 000	2 600	9.290	-	-
	250	68	3.0	3.0	169	-	-	NU2228EM	530.4	754.6	75.09	2 000	2 600	14.700	HJ2228	1.080
	250	68	3.0	3.0	169	-	-	NJ2228EM	530.4	754.6	75.09	2 000	2 600	14.700	HJ2228	1.080
	250	68	3.0	3.0	169	-	-	NUP2228EM	530.4	754.6	75.09	2 000	2 600	14.700	-	-
	250	68	3.0	3.0	-	225	-	N2228EM	530.4	754.6	75.09	2 000	2 600	14.700	-	-
	250	68	3.0	3.0	-	225	-	NF2228EM	530.4	754.6	75.09	2 000	2 600	14.700	-	-
	300	62	4.0	4.0	180	-	-	NU328EM	649.8	798.3	76.84	1 700	2 100	23.000	HJ328	2.050
	300	62	4.0	4.0	180	-	-	NJ328EM	649.8	798.3	76.84	1 700	2 100	23.000	HJ328	2.050
	300	62	4.0	4.0	180	-	-	NUP3208EM	649.8	798.3	76.84	1 700	2 100	23.000	-	-
	300	62	4.0	4.0	-	260	-	N328EM	649.8	798.3	76.84	1 700	2 100	23.000	-	-
300	62	4.0	4.0	-	260	-	NF3208EM	649.8	798.3	76.84	1 700	2 100	23.000	-	-	
150	225	35	2.1	1.5	169.5	-	NU1030EM	208.0	310.0	31.30	2 700	3 200	4.930	-	-	
	225	35	2.1	1.5	169.5	-	NJ1030EM	208.0	310.0	31.30	2 700	3 200	4.930	-	-	
	225	35	2.1	1.5	169.5	-	NUP1030EM	208.0	310.0	31.30	2 700	3 200	4.930	-	-	
	270	45	3.0	3.0	182	-	-	NU230EM	435.0	571.1	55.75	1 900	2 400	11.900	HJ230	1.260
	270	45	3.0	3.0	182	-	-	NJ230EM	435.0	571.1	55.75	1 900	2 400	11.900	HJ230	1.260
	270	45	3.0	3.0	182	-	-	NUP230EM	435.0	571.1	55.75	1 900	2 400	11.900	-	-
	270	45	3.0	3.0	-	242	-	N230EM	435.0	571.1	55.75	1 900	2 400	11.900	-	-

Single Row Cylindrical Roller Bearings

d = 150 - 190 mm

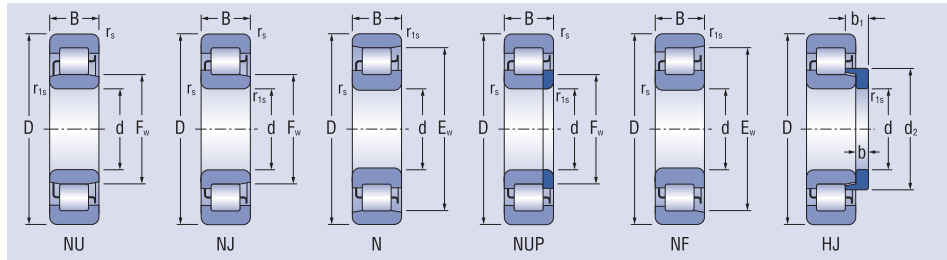

Dimensions							Bearing designation	Basic load rating		Fatigue load limit	Limiting speed		Mass of Bearings	Separate Thrust Collar	Mass of separate Thrust Collar
d	D	B	r _s min	r _{s1} min	F _w	E _w		C _r	C _{0r}		grease	oil			
mm							kN			min ⁻¹					
150	270	45	3.0	3.0	-	242	NF230EM	435.0	571.1	55.75	1 900	2 400	11.900	-	-
	270	73	3.0	3.0	182	-	NU2230EM1	640.0	938.3	91.59	1 900	2 500	18.500	HJ2230	1.350
	270	73	3.0	3.0	182	-	NJ2230EM1	640.0	938.3	91.59	1 900	2 500	18.500	HJ2230	1.350
	270	73	3.0	3.0	-	242	NUP2230EM1	640.0	938.3	91.59	1 900	2 500	18.500	-	-
	270	73	3.0	3.0	-	242	N2230EM1	640.0	938.3	91.59	1 900	2 500	18.500	-	-
	270	73	3.0	3.0	-	242	NF2230EM1	640.0	938.3	91.59	1 900	2 500	18.500	-	-
	320	65	4.0	4.0	193	-	NU330EM	772.0	944.1	88.91	1 600	2 000	28.500	HJ330	2.300
	320	65	4.0	4.0	193	-	NJ330EM	772.0	944.1	88.91	1 600	2 000	28.500	HJ330	2.300
	320	65	4.0	4.0	193	-	NUP330EM	772.0	944.1	88.91	1 600	2 000	28.500	-	-
	320	65	4.0	4.0	-	283	N330EM	772.0	944.1	88.91	1 600	2 000	28.500	-	-
320	65	4.0	4.0	-	283	NF330EM	772.0	944.1	88.91	1 600	2 000	28.500	-	-	
160	240	38	2.1	1.5	180	-	NU1032EM	245.0	355.0	35.16	2 500	3 000	5.920	-	-
	240	38	2.1	1.5	180	-	NJ1032EM	245.0	355.0	35.16	2 500	3 000	5.920	-	-
	240	38	2.1	1.5	180	-	NUP1032EM	245.0	355.0	35.16	2 500	3 000	5.920	-	-
	290	48	3.0	3.0	195	-	NU232EM	492.0	653.1	62.45	1 800	2 300	14.500	HJ232	1.500
	290	48	3.0	3.0	195	-	NJ232EM	492.0	653.1	62.45	1 800	2 300	14.500	HJ232	1.500
	290	48	3.0	3.0	195	-	NUP232EM	492.0	653.1	62.45	1 800	2 300	14.500	-	-
	290	48	3.0	3.0	-	259	N232EM	492.0	653.1	62.45	1 800	2 300	14.500	-	-
	290	48	3.0	3.0	-	259	NF232EM	492.0	653.1	62.45	1 800	2 300	14.500	-	-
170	260	42	2.1	2.1	193	-	NU1034EM	300.0	430.0	41.68	2 300	2 800	7.960	-	-
	260	42	2.1	2.1	193	-	NJ1034EM	300.0	430.0	41.68	2 300	2 800	7.960	-	-
	260	42	2.1	2.1	193	-	NUP1034EM	300.0	430.0	41.68	2 300	2 800	7.960	-	-
	310	52	4.0	4.0	207	-	NU234EM	586.0	770.7	72.28	1 700	2 200	19.000	HJ234	1.650
	310	52	4.0	4.0	207	-	NJ234EM	586.0	770.7	72.28	1 700	2 200	19.000	HJ234	1.650
	310	52	4.0	4.0	207	-	NUP234EM	586.0	770.7	72.28	1 700	2 200	19.000	-	-
	310	52	4.0	4.0	-	279	N234EM	586.0	770.7	72.28	1 700	2 200	19.000	-	-
	310	52	4.0	4.0	-	279	NF234EM	586.0	770.7	72.28	1 700	2 200	19.000	-	-
180	280	46	2.1	2.1	205	-	NU1036EM	360.0	520.0	49.39	2 100	2 600	10.500	-	-
	280	46	2.1	2.1	205	-	NJ1036EM	360.0	520.0	49.39	2 100	2 600	10.500	-	-
	280	46	2.1	2.1	205	-	NUP1036EM	360.0	520.0	49.39	2 100	2 600	10.500	-	-
	320	52	4.0	4.0	217	-	NU236EM	609.6	821.7	76.12	1 600	2 000	21.000	HJ236	1.700
	320	52	4.0	4.0	217	-	NJ236EM	609.6	821.7	76.12	1 600	2 000	21.000	HJ236	1.700
	320	52	4.0	4.0	217	-	NUP236EM	609.6	821.7	76.12	1 600	2 000	21.000	-	-
	320	52	4.0	4.0	-	289	N236EM	609.6	821.7	76.12	1 600	2 000	21.000	-	-
	320	52	4.0	4.0	-	289	NF236EM	609.6	821.7	76.12	1 600	2 000	21.000	-	-
	190	290	46	2.1	2.1	215	-	NU1038EM	365.0	550.0	51.57	2 000	2 400	10.900	-
290		46	2.1	2.1	215	-	NJ1038EM	365.0	550.0	51.57	2 000	2 400	10.900	-	-
290		46	2.1	2.1	215	-	NUP1038EM	365.0	550.0	51.57	2 000	2 400	10.900	-	-

Single Row Cylindrical Roller Bearings

d = 200 - 300 mm

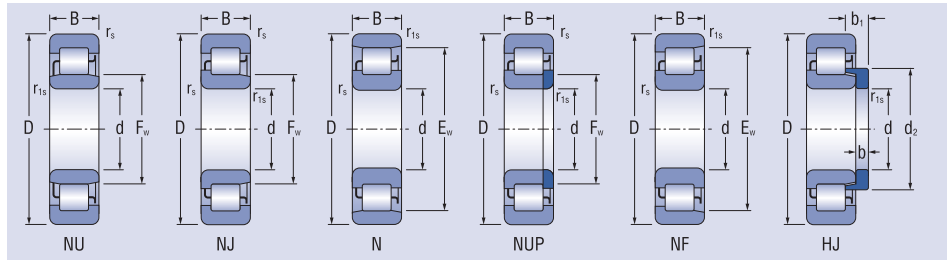

Dimensions							Bearing designation	Basic load rating		Fatigue load limit	Limiting speed for lubrication with		Mass of Bearings	Separate Thrust Collar	Mass of separate Thrust Collar
d	D	B	r _s min	r _{s1} min	F _w	E _w		C _r	C _{0r}		grease	oil			
mm							kN			min ⁻¹					
200	310	51	2.1	2.1	229	-	NU1040EM	400.0	600.0	55.25	1 900	2 200	14.100	-	-
	310	51	2.1	2.1	229	-	NJ1040EM	400.0	600.0	55.25	1 900	2 200	14.100	-	-
	310	51	2.1	2.1	229	-	NUP1040EM	400.0	600.0	55.25	1 900	2 200	14.100	-	-
	380	58	4.0	4.0	243	-	NU240EM	745.1	1 022.8	91.60	1 400	1 800	38.000	HJ240	2.550
	380	58	4.0	4.0	243	-	NJ240EM	745.1	1 022.8	91.60	1 400	1 800	38.000	HJ240	2.550
	380	58	4.0	4.0	243	-	NUP240EM	745.1	1 022.8	91.60	1 400	1 800	38.000	-	-
	380	58	4.0	4.0	-	323	N240EM	745.1	1 022.8	91.60	1 400	1 800	38.000	-	-
	380	58	4.0	4.0	-	323	NF240EM	745.1	1 022.8	91.60	1 400	1 800	38.000	-	-
220	340	56	3.0	3.0	250	-	NU1044EM	510.0	765.0	68.50	1 700	2 000	18.500	-	-
	340	56	3.0	3.0	250	-	NJ1044EM	510.0	765.0	68.50	1 700	2 000	18.500	-	-
	340	56	3.0	3.0	250	-	NUP1044EM	510.0	765.0	68.50	1 700	2 000	18.500	-	-
240	360	56	3.0	3.0	270	-	NU1048EM	540.0	850.0	74.55	1 600	1 900	20.400	-	-
	360	56	3.0	3.0	270	-	NJ1048EM	540.0	850.0	74.55	1 600	1 900	20.400	-	-
	360	56	3.0	3.0	270	-	NUP1048EM	540.0	850.0	74.55	1 600	1 900	20.400	-	-
260	400	65	4.0	4.0	296	-	NU1052EM	655.0	1 020.0	86.94	1 500	1 800	29.900	-	-
	400	65	4.0	4.0	296	-	NJ1052EM	655.0	1 020.0	86.94	1 500	1 800	29.900	-	-
	400	65	4.0	4.0	296	-	NUP1052EM	655.0	1 020.0	86.94	1 500	1 800	29.900	-	-
280	420	65	4.0	4.0	316	-	NU1056EM	680.0	1 100.0	92.12	1 350	1 600	31.400	-	-
	420	65	4.0	4.0	316	-	NJ1056EM	680.0	1 100.0	92.12	1 350	1 600	31.400	-	-
	420	65	4.0	4.0	316	-	NUP1056EM	680.0	1 100.0	92.12	1 350	1 600	31.400	-	-
300	460	74	4.0	4.0	340	-	NU1060EM	900.0	1 430.0	116.83	1 200	1 400	44.300	-	-
	460	74	4.0	4.0	340	-	NJ1060EM	900.0	1 430.0	116.83	1 200	1 400	44.300	-	-
	460	74	4.0	4.0	340	-	NUP1060EM	900.0	1 430.0	116.83	1 200	1 400	44.300	-	-



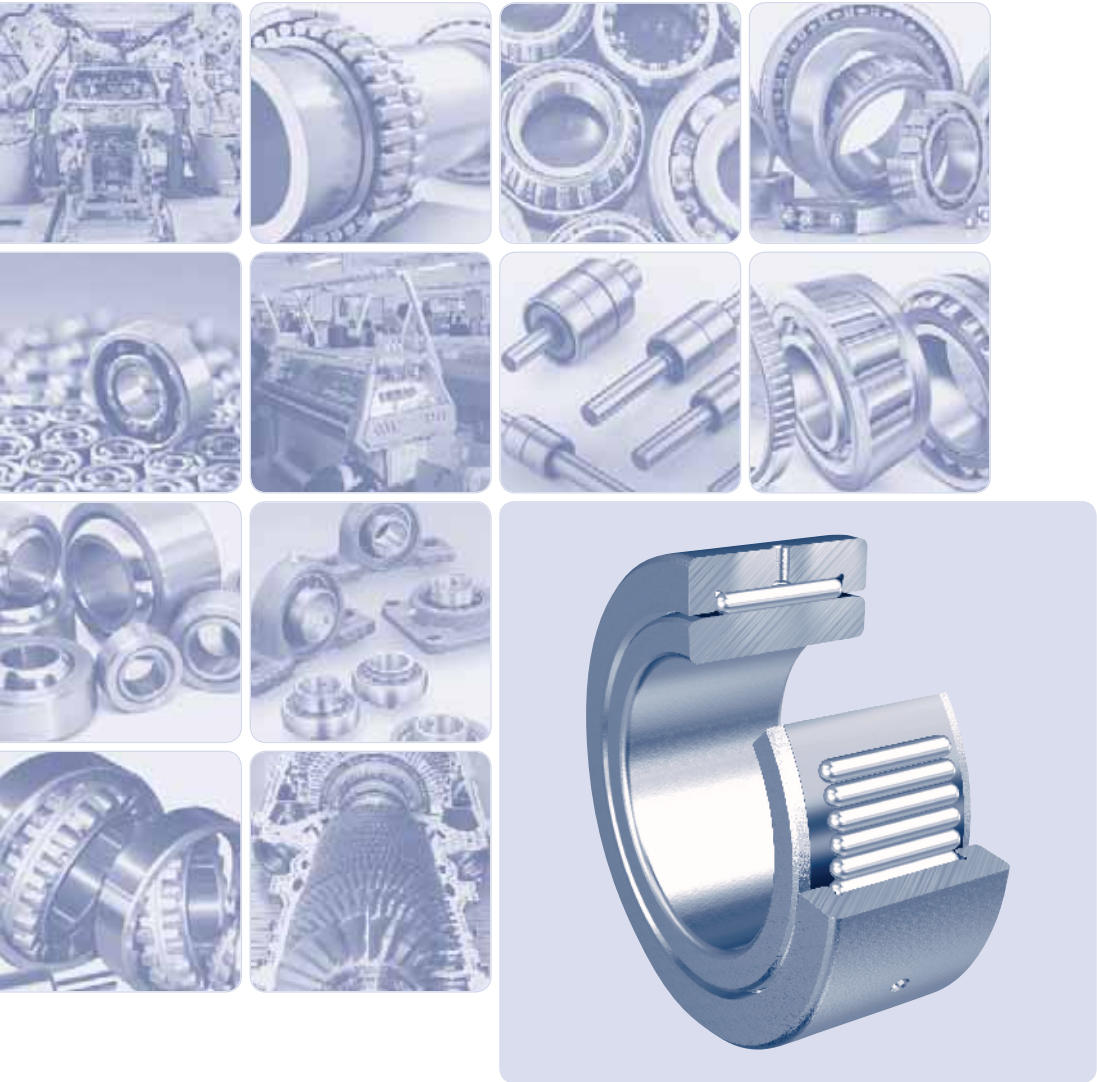

Needle Roller Bearings

Needle bearings with guide ribs without and with inner ring

Needle bearings with guide ribs without and with inner ring

Needle bearings without inner ring and with inner ring are the roller bearings for high loading with simple spatial construction. Needle rollers guided evenly to the axis in fix cage are made with tolerance diameter of 2 µm. Outer ring with ribs and a cage with needle rollers create the construction unit.

Needle bearings with ribs without inner ring are supplied in following design: NK, NKS, RNA 49, RNA 69.

Needle bearings with ribs with inner ring are supplied in following design: NKI, NKIS, NA48, NA49, NA 69.

Needle bearings with ribs without inner ring

Needle bearings without inner ring allow optimal solution of the placing problem, whereby the raceway on the shaft may be hardened or grinded. Compared to the bearings with inner ring, it is possible to produce reinforced shafts and enhance the operation accuracy of the bearing as the tolerance of inner ring is eliminated.

The shell circle of these needle bearings when not assembled is in the tolerance field of F6. The shell circle is a inner circle made by the needle rollers when they touch to the raceway of the outer ring without clearance.

For lubrication purposes the bearings have a lubrication groove and opening, this does not apply for bearings NK F ≤ 10 mm.

Needle bearings with ribs, with inner rings

The design with inner ring is used when the raceway cannot be made on the shaft. Outer ring with a cage and inner ring may be assembled independently.

The shift values ("s") specified in the dimension tables cannot be exceeded in view of the manufacturing tolerances and the thermal expansion of connecting elements during operation. If the table values are insufficient, needle bearings may be combined with wider IR and LR rings, as shown in the dimension tables.

For lubrication purposes the bearings have a lubrication groove and opening, this does not apply for bearings NKI d ≤ 7 mm.

Main dimensions

Main dimensions of needle bearings, which are given by the dimensional tables, correspond to the international dimensional plan of ISO 1206.

Designation

Designation of needle roller bearings in the basic design is stated in dimensional tables.

Cages

Needle bearings have a steel cage which is not marked. For special cases of placing some bearings are made with a polyamide cage which is marked TV. Supply of the bearings with this cage must be negotiated in advance.

Tolerance

Needle bearings are produced in normal tolerance degree P0 (P0 symbol is not marked). For special placing, demanding high accuracy, bearings with higher degree of accuracy P6 are supplied.

Radial clearance

Normally produced needle bearings have normal radial clearance which is not marked. Bearings with reduced (C2) or increased (C3, C4, C5) radial clearance are supplied for special placing cases.

The radial clearance of needle roller bearings with inner rings corresponds to the ISO 5753-1 norm.

Misalignment

In the case of needle bearings with inner rings, rings can only be tilted slightly. The admissible misalignment is up to 2°. The specific admissible misalignment depends on the internal bearing design, radial clearance during operation, and the force and torque transmitted by the bearing. The quoted value is therefore approximate.

Dynamic equivalent radial load

$$P_r = F_r$$

Static equivalent radial load

$$P_{or} = F_r$$

Needle bearings with guide ribs without inner ring

d = 5 - 22 mm

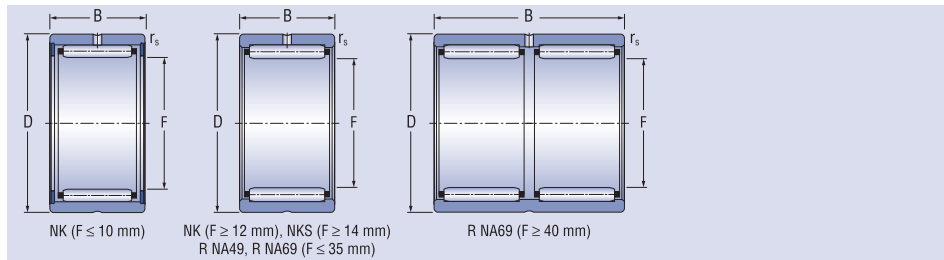

Dimensions					Designation	Basic load ratings		Fatigue load limit	Limiting speeds for lubrication with		Mass
d	D	B	r _s	F		C _r	C _{0r}		grease	oil	
mm	mm	mm	mm	mm		kN			min ⁻¹	kg	
5	10	10	0.15	5	NK5/10TV	2.1	1.8	0.214	26 000	40 000	0.004
	10	12	0.15	5	NK5/12TV	2.9	2.7	0.329	26 000	40 000	0.004
6	12	10	0.15	6	NK6/10	2.6	2.2	0.268	22 000	36 000	0.005
	12	12	0.15	6	NK6/12TN	3.4	3.1	0.384	22 000	36 000	0.006
7	14	10	0.3	7	NK7/10TN	2.9	2.7	0.329	20 000	34 000	0.007
	14	12	0.3	7	NK7/12TN	3.7	3.6	0.439	20 000	34 000	0.009
8	15	12	0.3	8	NK8/12	4.0	4.1	0.500	19 000	32 000	0.011
	15	16	0.3	8	NK8/16	5.6	5.8	0.707	19 000	32 000	0.013
9	16	12	0.3	9	NK9/12	4.9	5.0	0.603	18 000	30 000	0.012
	16	16	0.3	9	NK9/16	6.5	7.1	0.865	18 000	30 000	0.015
10	17	12	0.3	10	NK10/12	5.2	5.5	0.670	17 000	28 000	0.013
	17	16	0.3	10	NK10/16	5.6	7.4	0.896	17 000	28 000	0.016
12	19	12	0.3	12	NK12/12	5.7	6.6	0.798	16 000	26 000	0.013
	19	16	0.3	12	NK12/16	8.2	9.8	1.195	16 000	26 000	0.018
14	22	13	0.3	14	R NA4900	8.2	9.2	1.115	16 000	26 000	0.018
	22	16	0.3	14	NK14/16	11.0	13.7	1.670	16 000	26 000	0.023
	22	20	0.3	14	NK14/20	13.2	17.3	2.109	16 000	26 000	0.028
15	23	16	0.3	15	NK15/16	10.8	13.7	1.670	16 000	26 000	0.024
	23	20	0.3	15	NK15/20	13.2	17.3	2.109	16 000	26 000	0.031
16	24	13	0.3	16	R NA4901	9.0	11.0	1.341	15 000	24 000	0.020
	24	16	0.3	16	NK16/16	11.4	15.0	1.829	15 000	24 000	0.025
	24	20	0.3	16	NK16/20	13.7	19.0	2.317	15 000	24 000	0.032
	24	22	0.3	16	R NA6901	14.3	20.0	2.439	15 000	24 000	0.036
17	25	16	0.3	17	NK17/16	12.0	16.0	1.951	15 000	24 000	0.027
	25	20	0.3	17	NK17/20	15.0	19.0	2.317	15 000	24 000	0.034
18	26	16	0.3	18	NK18/16	12.0	16.3	1.987	15 000	24 000	0.028
	26	20	0.3	18	NK18/20	14.3	20.4	2.487	15 000	24 000	0.035
19	27	16	0.3	19	NK19/16	13.0	17.0	2.073	14 000	22 000	0.037
	27	20	0.3	19	NK19/20	15.0	22.0	2.682	14 000	22 000	0.039
20	28	13	0.3	20	R NA4902	11.0	12.9	1.573	13 000	20 000	0.023
	28	16	0.3	20	NK20/16	12.5	17.6	2.146	13 000	20 000	0.032
	28	20	0.3	20	NK20/20	15.6	23.6	2.878	13 000	20 000	0.038
	28	23	0.3	20	R NA6902	16.6	25.5	3.109	13 000	20 000	0.042
21	32	20	0.6	20	NKS20	22.0	25.0	3.048	13 000	20 000	0.058
	29	16	0.3	21	NK21/16	13.4	20.0	2.439	13 000	20 000	0.032
22	29	20	0.3	21	NK21/20	16.3	25.0	3.048	13 000	20 000	0.040
	30	13	0.3	22	R NA4903	10.4	14.6	1.780	12 000	19 000	0.025
	30	16	0.3	22	NK22/16	13.4	20.0	2.439	12 000	19 000	0.033
	30	20	0.3	22	NK22/20	16.0	25.0	3.048	12 000	19 000	0.041
	30	23	0.3	22	R NA6903	18.0	29.0	3.536	12 000	19 000	0.056
	35	20	0.6	22	NKS22	20.8	25.5	3.109	12 000	19 000	0.069

Needle bearings with guide ribs without inner ring

d = 24 - 38 mm

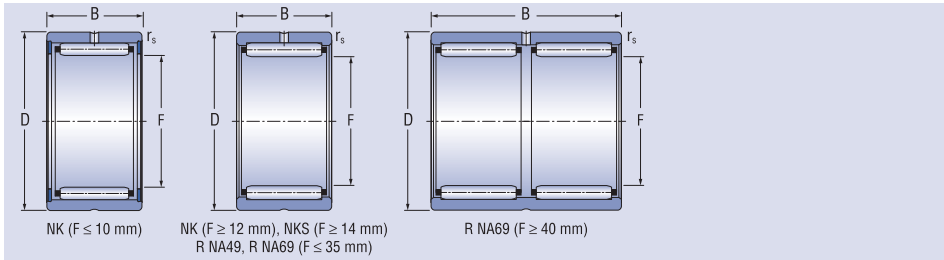

Dimensions					Designation	Basic load ratings		Fatigue load limit	Limiting speeds for lubrication with		Mass
d	D	B	r _s	F		C _r	C _{0r}		grease	oil	
mm	mm	mm	mm	mm		kN			min ⁻¹		
24	32	16	0.3	24	NK24/16	14.3	22.4	2.731	10 000	17 000	0.035
	32	20	0.3	24	NK24/20	17.3	28.5	3.475	10 000	17 000	0.045
	37	20	0.6	24	NKS24	26.0	31.0	3.780	10 000	17 000	0.073
25	33	16	0.3	25	NK25/16	14.3	22.4	2.731	10 000	17 000	0.037
	33	20	0.3	25	NK25/20	17.0	28.5	3.475	10 000	17 000	0.047
	37	17	0.3	25	R NA4904	19.0	23.6	2.878	10 000	17 000	0.061
	37	30	0.3	25	R NA6904	33.5	49.0	5.975	10 000	17 000	0.091
	38	20	0.6	25	NKS25	25.8	31.0	3.780	10 000	17 000	0.076
26	34	16	0.3	26	NK26/16	14.6	23.6	2.878	9 500	16 000	0.039
	34	20	0.3	26	NK26/20	17.6	30.0	3.658	9 500	16 000	0.048
28	37	20	0.3	28	NK28/20	20.0	32.0	3.902	9 000	15 000	0.057
	37	30	0.3	28	NK28/30	26.5	52.0	6.341	9 000	15 000	0.088
	39	17	0.3	28	R NA49/22	20.8	27.5	3.353	9 000	15 000	0.059
	39	30	0.3	28	R NA69/22	40.8	51.0	6.219	9 000	15 000	0.107
	42	20	0.6	28	NKS28	27.5	36.5	4.451	9 000	15 000	0.094
29	38	20	0.3	29	NK29/20	20.8	34.0	4.146	8 500	14 000	0.059
	38	30	0.3	29	NK29/30	27.0	54.0	6.585	8 500	14 000	0.090
30	40	20	0.3	30	NK30/20	21.6	36.0	4.390	8 500	14 000	0.071
	40	30	0.3	30	NK30/30	31.5	58.5	7.134	8 500	14 000	0.107
	42	17	0.3	30	R NA4905	21.6	30.0	3.658	8 500	14 000	0.071
	42	30	0.3	30	R NA6905	36.5	57.0	6.951	8 500	14 000	0.127
	45	22	0.6	30	NKS30	31.0	40.5	4.939	8 500	14 000	0.114
32	42	20	0.3	32	NK32/20	22.0	37.5	4.573	8 000	13 000	0.074
	42	30	0.3	32	NK32/30	32.5	62.0	7.560	8 000	13 000	0.122
	45	17	0.3	32	R NA49/28	22.4	31.5	3.841	8 000	13 000	0.080
	45	30	0.3	32	R NA69/28	40.0	60.0	7.317	8 000	13 000	0.140
	47	22	0.6	32	NKS32	32.5	44.0	5.365	8 000	13 000	0.120
35	45	20	0.3	35	NK35/20	23.2	41.5	5.060	7 500	12 000	0.081
	45	30	0.3	35	NK35/30	34.0	68.0	8.292	7 500	12 000	0.122
	47	17	0.3	35	R NA4906	23.2	33.5	4.085	7 500	12 000	0.081
	47	30	0.3	35	R NA6906	39.0	65.5	7.987	7 500	12 000	0.148
	50	22	0.6	35	NKS35	34.0	47.5	5.792	7 500	12 000	0.130
37	47	20	0.3	37	NK37/20	23.6	43.5	5.304	7 000	11 000	0.084
	47	30	0.3	37	NK37/30	34.5	71.0	8.658	7 000	11 000	0.128
	52	22	0.6	37	NKS37	35.5	51.0	6.219	7 000	11 000	0.134
38	48	20	0.3	38	NK38/20	20.8	41.5	5.060	7 000	11 000	0.087
	48	30	0.3	38	NK38/30	30.5	68.0	8.292	7 000	11 000	0.131

Needle bearings with guide ribs without inner ring

d = 40 - 68 mm

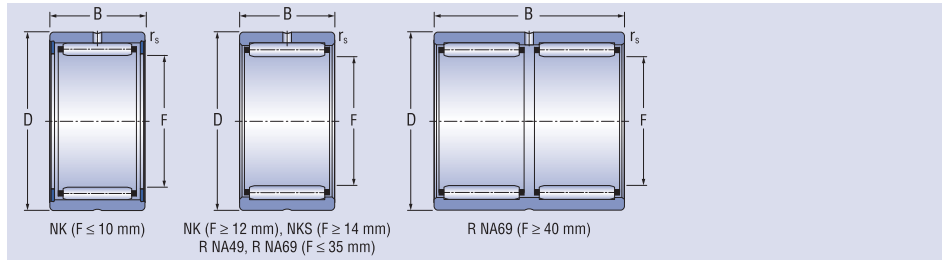

Dimensions					Designation	Basic load ratings		Fatigue load limit	Limiting speeds for lubrication with		Mass
d	D	B	rs	F		dynamic	static		grease	oil	
mm	mm	mm	mm	mm		C _r	C _{0r}	C _u	min ⁻¹	min ⁻¹	kg
40	50	20	0.3	40	NK40/20	25.0	47.5	5.792	6 700	10 000	0.089
	50	30	0.3	40	NK40/30	36.5	76.5	9.329	6 700	10 000	0.137
	52	20	0.6	40	R NA49/32	28.5	46.5	5.670	6 700	10 000	0.100
	52	36	0.6	40	R NA69/32	43.0	78.0	9.512	6 700	10 000	0.185
	55	22	0.6	40	NKS40	36.5	54.0	6.585	6 700	10 000	0.140
42	52	20	0.3	42	NK42/20	25.5	49.0	5.764	6 700	10 000	0.085
	52	30	0.3	42	NK42/30	37.5	80.0	9.756	6 700	10 000	0.141
	55	20	0.6	42	R NA4907	29.0	49.0	5.975	6 700	10 000	0.114
	55	36	0.6	42	R NA6907	44.0	83.0	10.121	6 700	10 000	0.218
43	53	20	0.3	43	NK43/20	25.7	51.0	6.219	6 300	9 500	0.096
	53	30	0.3	43	NK43/30	38.0	83.0	10.121	6 300	9 500	0.134
	58	22	0.6	43	NKS43	37.5	57.0	6.951	6 300	9 500	0.150
45	55	20	0.3	45	NK45/20	26.5	53.0	6.463	6 300	9 500	0.100
	55	30	0.3	45	NK45/30	39.0	86.5	10.548	6 300	9 500	0.151
	60	22	0.6	45	NKS45	39.0	61.0	7.439	6 300	9 500	0.156
47	57	20	0.3	47	NK47/20	27.0	55.0	6.707	6 000	9 000	0.104
	57	30	0.3	47	NK47/30	39.0	90.0	10.975	6 000	9 000	0.158
48	62	22	0.6	48	R NA4908	40.0	64.0	7.804	5 600	8 500	0.154
	62	40	0.6	48	R NA6908	64.0	118.0	14.390	5 600	8 500	0.300
50	62	25	0.6	50	NK50/25	37.5	76.5	9.329	5 600	8 500	0.171
	62	35	0.6	50	NK50/35	51.0	114.0	13.902	5 600	8 500	0.242
	65	22	1.0	50	NKS50	41.5	68.0	8.292	5 600	8 500	0.170
52	68	22	0.6	52	R NA4909	41.5	69.5	8.475	5 300	8 000	0.201
	68	40	0.6	52	R NA6909	65.5	125.0	15.243	5 300	8 000	0.392
55	68	25	0.6	55	NK55/25	41.5	81.5	5.060	5 000	7 500	0.207
	68	35	0.6	55	NK55/35	57.0	122.0	14.878	5 000	7 500	0.293
	72	22	1.0	55	NKS55	42.5	72.0	8.780	5 000	7 500	0.225
58	72	22	0.6	58	R NA4910	43.0	76.5	9.329	4 800	7 000	0.179
	72	40	0.6	58	R NA6910	67.0	132.0	16.097	4 800	7 000	0.364
60	72	25	0.6	60	NK60/25	40.0	88.0	10.731	4 800	7 000	0.202
	72	35	0.6	60	NK60/35	55.0	132.0	16.097	4 800	7 000	0.286
	80	28	1.1	60	NKS60	60.0	98.0	11.951	4 800	7 000	0.337
63	80	25	1.0	63	R NA4911	56.0	99.6	12.146	4 500	6 700	0.285
	80	45	1.0	63	R NA6911	83.0	160.0	19.512	4 500	6 700	0.540
65	78	25	0.6	65	NK65/25	43.0	91.5	11.158	4 300	6 300	0.257
	78	35	0.6	65	NK65/35	60.0	137.0	16.707	4 300	6 300	0.300
	85	28	1.1	65	NKS65	64.0	108.0	13.170	4 300	6 300	0.362
68	82	25	0.6	68	NK68/25	43.5	95.0	11.585	4 000	6 000	0.287
	82	35	0.6	68	NK68/35	60.0	143.0	17.439	4 000	6 000	0.350
	85	25	1.0	68	R NA4912	58.5	108.0	13.170	4 000	6 000	0.304
	85	45	1.0	68	R NA6912	71.0	176.0	21.463	4 000	6 000	0.570

Needle bearings with guide ribs without inner ring

d = 70 - 125 mm

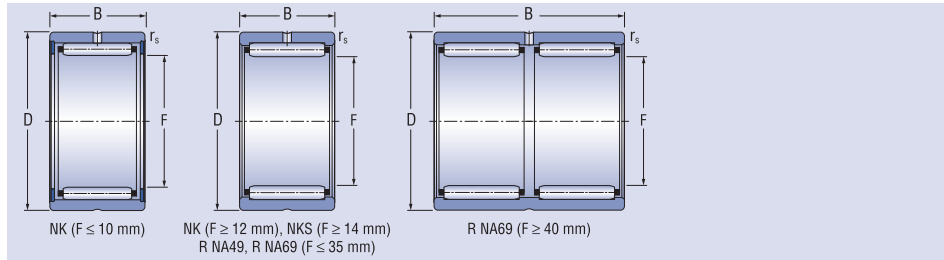

Dimensions					Designation	Basic load ratings		Fatigue load limit	Limiting speeds for lubrication with		Mass
d	D	B	r _s	F		C _r	C _{0r}		grease	oil	
mm	mm	mm	mm	mm		kN			min ⁻¹		
70	85	25	0.6	70	NK70/25	41.5	90.5	11.036	4 000	6 000	0.298
	85	35	0.6	70	NK70/35	58.5	140.0	17.073	4 000	6 000	0.411
	90	28	1.1	70	NKS70	65.5	114.0	13.902	4 000	6 000	0.383
72	90	25	1.0	72	R NA4913	58.5	114.0	13.902	4 000	6 000	0.346
	90	45	1.0	72	R NA6913	95.0	196.0	23.902	4 000	6 000	0.679
73	90	25	0.6	73	NK73/25	95.0	112.0	13.658	3 800	5 600	0.320
	90	35	0.6	73	NK73/35	75.0	166.0	20.243	3 800	5 600	0.450
75	92	25	0.6	75	NK75/25	41.5	91.5	11.158	3 800	5 600	0.364
	92	23	0.6	75	NK75/35	58.5	143.0	17.439	3 800	5 600	0.518
	95	28	1.1	75	NKS75	69.5	125.0	15.243	3 800	5 600	0.413
80	95	25	1.0	80	NK80/25	58.5	122.0	14.878	3 600	5 300	0.331
	95	35	1.0	80	NK80/35	72.0	176.0	21.463	3 600	5 300	0.380
	100	30	1.0	80	R NA4914	78.0	150.0	18.292	3 600	5 300	0.502
	100	54	1.0	80	R NA6914	125.0	270.0	32.926	3 600	5 300	0.946
85	105	25	1.0	85	NK85/25	69.0	129.0	15.731	3 400	5 000	0.400
	105	30	1.0	85	R NA4915	80.0	156.0	19.024	3 400	5 000	0.528
	105	35	1.0	85	NK85/35	98.0	208.0	25.365	3 400	5 000	0.712
	105	54	1.0	85	R NA6915	129.0	290.0	35.365	3 400	5 000	1.020
90	110	25	1.0	90	NK90/25	72.0	140.0	17.073	3 000	4 500	0.530
	110	30	1.0	90	R NA4916	83.0	170.0	20.731	3 000	4 500	0.556
	110	35	1.0	90	NK90/35	102.0	220.0	26.829	3 000	4 500	0.620
	110	54	1.0	90	R NA6916	118.0	320.0	39.024	3 000	4 500	1.050
95	115	26	1.0	95	NK95/26	46.5	116.0	14.146	3 000	4 500	0.572
	115	36	1.0	95	NK95/36	104.0	228.0	27.804	3 000	4 500	0.640
100	120	26	1.0	100	NK100/26	75.0	153.0	18.334	2 800	4 300	0.480
	120	35	1.1	100	R NA4917	100.0	220.0	26.346	2 800	4 300	0.715
	120	36	1.1	100	NK100/36	108.0	245.0	29.340	2 800	4 300	0.658
	120	63	1.1	100	R NA6917	143.0	415.0	49.698	2 800	4 300	1.150
105	125	26	1.0	105	NK105/26	50.0	129.0	15.448	2 600	4 000	0.625
	125	35	1.1	105	R NA4918	104.0	236.0	28.262	2 600	4 000	0.746
	125	36	1.0	105	NK105/36	69.5	196.0	23.472	2 600	4 000	0.870
	125	63	1.1	105	R NA6918	160.0	405.0	48.501	2 600	4 000	1.300
110	130	30	1.1	110	NK110/30	93.0	208.0	24.909	2 400	3 800	0.600
	130	35	1.1	110	R NA4919	106.0	245.0	29.340	2 400	3 800	0.777
	130	40	1.1	110	NK110/40	122.0	290.0	34.729	2 400	3 800	0.900
	130	63	1.1	110	R NA6919	150.0	455.0	54.489	2 400	3 800	1.470
115	140	40	1.1	115	R NA4920	127.0	285.0	34.130	2 200	3 600	1.220
125	150	40	1.1	125	R NA4922	134.0	315.0	51.640	2 000	3 400	1.320
	150	40	1.1	125	R NA4922	134.0	315.0	51.640	2 000	3 400	1.320

Needle roller bearings with inner ring NKI, NKIS, NA48, NA49, NA69

d = 5 - 25 mm

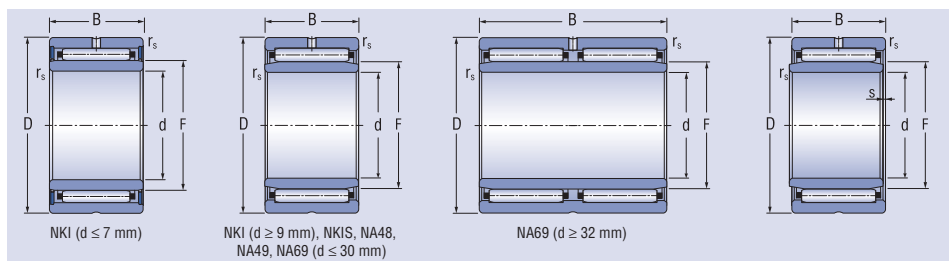

Dimensions						Designation	Basic load ratings		Fatigue load limit	Limiting speeds for lubrication with		Mass
d	D	B	r _s	F	s		C _r	C _{0r}		grease	oil	
mm						kN			min ⁻¹	kg		
5	15	12	0.3	8	1.5	NKI5/12TV	4.4	5.0	0.609	19 000	32 000	0.014
	15	16	0.3	8	2.0	NKI5/16TV	5.6	6.8	0.829	19 000	32 000	0.017
6	16	12	0.3	9	1.5	NKI6/12TV	4.1	4.8	0.585	18 000	30 000	0.015
	16	16	0.3	9	2.0	NKI6/16TV	5.9	7.7	0.939	18 000	30 000	0.019
7	17	12	0.3	10	1.5	NKI7/12TV	5.2	6.6	0.804	17 000	28 000	0.017
	17	16	0.3	10	2.0	NKI7/16TV	5.6	7.4	0.902	17 000	28 000	0.021
9	19	12	0.3	12	1.5	NKI9/12TV	6.4	7.7	0.939	16 000	26 000	0.018
	19	16	0.3	12	2.0	NKI9/16TV	6.4	9.2	1.121	16 000	26 000	0.024
10	22	13	0.3	14	0.5	NA4900	8.2	9.2	1.121	16 000	26 000	0.025
	22	16	0.3	14	0.5	NKI10/16	11.0	13.7	1.670	16 000	26 000	0.032
	22	20	0.3	14	0.5	NKI10/20	13.2	17.3	2.109	16 000	26 000	0.040
12	24	13	0.3	16	0.5	NA4901	9.0	11.0	1.341	15 000	24 000	0.028
	24	16	0.3	16	0.5	NKI12/16	11.4	15.0	1.829	15 000	24 000	0.036
	24	20	0.3	16	0.5	NKI12/20	13.7	19.0	2.317	15 000	24 000	0.046
	24	22	0.3	16	1.0	NA6901	14.3	20.0	2.439	15 000	24 000	0.051
15	27	16	0.3	19	0.5	NKI15/16	12.5	17.3	2.109	14 000	22 000	0.042
	27	20	0.3	19	0.5	NKI15/20	15.0	22.0	2.682	14 000	22 000	0.054
	28	13	0.3	20	0.5	NA4902	10.2	13.7	1.670	13 000	20 000	0.037
	28	23	0.3	20	1.0	NA6902	16.6	25.5	3.109	13 000	20 000	0.067
17	29	16	0.3	21	0.5	NKI17/16	13.4	20.0	2.439	13 000	20 000	0.047
	29	20	0.3	21	0.5	NKI17/20	16.3	25.0	3.048	13 000	20 000	0.059
	30	13	0.3	22	0.5	NA4903	10.4	14.6	1.780	12 000	19 000	0.040
	30	23	0.3	22	1.0	NA6903	18.0	29.0	3.536	12 000	19 000	0.084
	37	20	0.3	24	0.5	NKIS17	26.0	31.0	3.780	10 000	17 000	0.108
20	32	16	0.3	24	0.5	NKI20/16	14.3	22.4	2.731	10 000	17 000	0.053
	32	20	0.3	24	0.5	NKI20/20	17.3	28.5	3.475	10 000	17 000	0.067
	37	17	0.3	25	0.8	NA4904	19.0	23.6	2.878	10 000	17 000	0.084
	37	30	0.3	25	1.0	NA6904	33.5	49.0	5.975	10 000	17 000	0.133
	42	20	0.3	28	0.5	NKIS20	27.5	36.5	4.451	9 000	15 000	0.130
22	34	16	0.3	26	0.5	NKI22/16	14.6	23.6	2.878	9 500	16 000	0.058
	34	20	0.3	26	0.5	NKI22/20	17.6	30.0	3.658	9 500	16 000	0.071
	39	17	0.3	28	0.8	NA49/22	20.8	27.5	3.353	9 000	15 000	0.089
	39	30	0.3	28	0.5	NA69/22	29.0	51.0	6.219	9 000	15 000	0.163
25	38	20	0.3	29	1.0	NKI25/20	20.8	34.0	4.146	8 500	14 000	0.086
	38	30	0.3	29	1.5	NKI25/30	27.0	54.0	6.585	8 500	14 000	0.130
	42	17	0.3	30	0.8	NA4905	21.6	30.0	3.658	8 500	14 000	0.099
	42	30	0.3	30	1.0	NA6905	36.5	57.0	6.951	8 500	14 000	0.178
	47	22	0.6	32	1.0	NKIS25	32.5	44.0	5.365	8 000	13 000	0.174

Needle roller bearings with inner ring NKI, NKIS, NA48, NA49, NA69

d = 28 - 50 mm

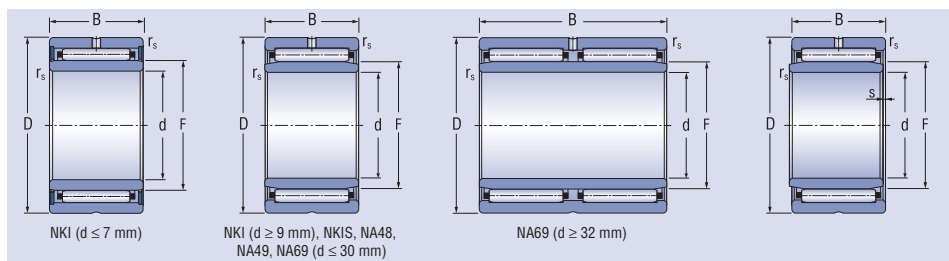

Dimensions						Designation	Basic load ratings		Fatigue load limit	Limiting speeds for lubrication with		Mass
d	D	B	r _s	F	s		C _r	C _{0r}		grease	oil	
mm	mm	mm	mm	mm	mm		kN			min ⁻¹		
28	42	20	0.3	32	1.0	NKI28/20	22.0	37.5	4.573	8 000	13 000	0.104
	42	30	0.3	32	1.5	NKI28/30	32.5	62.0	7.560	8 000	13 000	0.156
	45	17	0.3	32	0.8	NA49/28	22.4	31.5	3.841	8 000	13 000	0.108
	45	30	0.3	32	1.0	NA69/28	40.0	60.0	7.317	8 000	13 000	0.190
30	45	20	0.3	35	1.0	NKI30/20	23.2	41.5	5.060	7 500	12 000	0.120
	45	30	0.3	35	1.5	NKI30/30	34.0	68.0	8.292	7 500	12 000	0.179
	47	17	0.3	35	0.8	NA4906	23.2	33.5	4.085	7 500	12 000	0.114
	47	30	0.3	35	1.0	NA6906	39.0	65.5	7.987	7 500	12 000	0.205
	52	22	0.6	37	1.0	NKIS30	35.5	51.0	6.219	7 000	11 000	0.198
32	47	20	0.3	37	0.5	NKI32/20	23.6	43.0	5.243	7 000	11 000	0.127
	47	30	0.3	37	1.0	NKI32/30	34.5	71.0	8.658	7 000	11 000	0.192
	52	20	0.6	40	0.8	NA49/32	28.5	46.5	5.670	6 700	10 000	0.169
	52	36	0.6	40	0.5	NA69/32	43.0	78.0	9.512	6 700	10 000	0.313
35	50	20	0.3	40	0.5	NKI35/20	25.0	47.5	8.320	6 700	10 000	0.135
	50	30	0.3	40	1.0	NKI35/30	36.5	76.5	9.329	6 700	10 000	0.208
	55	20	0.6	42	0.8	NA4907	29.0	49.0	5.975	6 700	10 000	0.179
	55	36	0.6	42	0.5	NA6907	44.0	83.0	10.121	6 700	10 000	0.340
	58	22	0.6	43	0.5	NKIS35	37.5	57.0	6.951	6 300	9 500	0.235
38	53	20	0.3	43	0.5	NKI38/20	26.0	51.0	6.219	6 300	9 500	0.146
	53	30	0.3	43	1.0	NKI38/30	38.0	83.0	10.121	6 300	9 500	0.196
40	55	20	0.3	45	0.5	NKI40/20	26.5	53.0	6.463	6 300	9 500	0.152
	55	30	0.3	45	1.0	NKI40/30	39.0	86.5	10.548	6 300	9 500	0.229
	62	22	0.6	48	1.0	NA4908	40.0	64.0	7.804	5 600	8 500	0.248
	62	40	0.6	48	0.5	NA6908	64.0	118.0	14.390	5 600	8 500	0.473
42	65	22	1.0	50	0.5	NKIS40	41.5	68.0	8.292	5 600	8 500	0.292
	57	20	0.3	47	0.5	NKI42/20	27.0	55.0	6.707	6 000	9 000	0.159
45	57	30	0.3	47	1.0	NKI42/30	39.0	90.0	10.975	6 000	9 000	0.241
	62	25	0.6	50	1.5	NKI45/25	37.5	76.5	9.329	5 600	8 500	0.244
	62	35	0.6	50	2.0	NKI45/35	51.0	114.0	13.902	5 600	8 500	0.345
	68	22	0.6	52	1.0	NA4909	41.5	69.5	8.475	5 300	8 000	0.291
	68	40	0.6	52	0.5	NA6909	65.5	125.0	15.243	5 300	8 000	0.559
50	72	22	1.0	55	0.5	NKIS45	42.5	72.0	8.780	5 300	7 500	0.360
	68	25	0.6	55	1.5	NKI50/25	41.5	81.5	9.939	5 000	7 500	0.288
	68	35	0.6	55	2.0	NKI50/35	57.0	122.0	14.352	5 000	7 500	0.406
	72	22	0.6	58	1.0	NA4910	43.0	76.5	9.329	4 800	7 000	0.296
	72	40	0.6	58	0.5	NA6910	67.0	132.0	16.097	4 800	7 000	0.577
80	28	1.1	60	2.0	NKIS50	60.0	98.0	11.951	4 800	7 000	0.523	

Needle roller bearings with inner ring NKI, NKIS, NA48, NA49, NA69

d = 55 - 95 mm

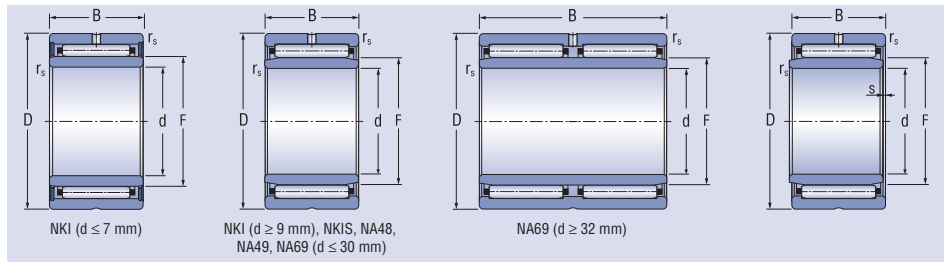

Dimensions						Designation	Basic load ratings		Fatigue load limit	Limiting speeds for lubrication with		Mass	
d	D	B	r _s	F	s		C _r	C _{0r}		grease	oil		
mm	mm	mm	mm	mm	mm		kN			min ⁻¹			
55	72	25	0.6	60	1.5	NKI55/25	40.0	88.0	10.731	4 800	7 000	0.290	
	72	35	0.6	60	2.0	NKI55/35	55.0	132.0	16.097	4 800	7 000	0.410	
	80	25	1.0	63	1.5	NA4911	56.0	100.0	12.195	4 500	6 700	0.426	
	80	45	1.0	63	1.5	NA6911	83.0	160.0	19.512	4 500	6 700	0.800	
	85	28	1.1	65	2.0	NKIS55	64.0	108.0	13.170	4 300	6 300	0.569	
60	82	25	0.6	68	1.0	NKI60/25	44.0	95.0	11.585	4 000	6 000	0.440	
	82	35	0.6	68	1.0	NKI60/35	60.0	143.0	17.439	4 000	6 000	0.520	
	85	25	1.0	68	1.5	NA4912	58.5	108.0	13.170	4 000	6 000	0.457	
	85	45	1.0	68	1.5	NA6912	71.0	176.0	21.463	4 000	6 000	0.854	
	90	28	1.1	70	2.0	NKIS60	65.5	114.0	13.902	4 000	6 000	0.607	
65	90	25	0.6	73	1.0	NKI65/25	55.0	112.0	13.658	3 800	5 600	0.500	
	90	25	1.0	72	1.0	NA4913	58.5	114.0	13.902	4 000	6 000	0.489	
	90	35	0.6	73	1.5	NKI65/35	75.0	166.0	20.243	3 800	5 600	0.690	
	90	45	1.0	72	1.5	NA6913	95.0	196.0	23.902	4 000	6 000	0.945	
	95	28	1.1	75	2.0	NKIS65	69.5	125.0	15.243	3 800	5 600	0.655	
70	95	25	1.0	80	0.8	NKI70/25	58.5	122.0	14.878	3 600	5 300	0.561	
	95	35	1.0	80	0.8	NKI70/35	72.0	176.0	21.463	3 600	5 300	0.700	
	100	28	1.1	80	1.5	NKIS70	72.0	137.0	16.707	3 400	5 000	0.680	
	100	30	1.0	80	1.5	NA4914	78.0	150.0	18.292	3 600	5 300	0.772	
	100	54	1.0	80	1.0	NA6914	125.0	270.0	32.926	3 600	5 300	1.450	
75	105	25	1.0	85	1.0	NKI75/25	69.5	129.0	15.731	3 400	5 000	0.640	
	105	30	1.0	85	1.5	NA4915	80.0	156.0	19.024	3 400	5 000	0.817	
	105	35	1.0	85	1.0	NKI75/35	98.0	208.0	25.365	3 400	5 000	1.050	
	105	54	1.0	85	1.0	NA6915	129.0	290.0	35.365	3 400	5 000	1.550	
80	110	25	1.0	90	1.0	NKI80/25	72.0	140.0	17.073	3 000	4 500	0.790	
	110	30	1.0	90	1.5	NA4916	83.0	170.0	20.731	3 000	4 500	0.862	
	110	35	1.0	90	1.0	NKI80/35	102.0	220.0	26.829	3 000	4 500	0.980	
	110	54	1.0	90	1.0	NA6916	118.0	320.0	39.024	3 000	4 500	1.620	
85	115	26	1.0	95	1.5	NKI85/26	46.5	116.0	14.146	3 000	4 500	0.862	
	115	36	1.0	95	1.5	NKI85/36	104.0	228.0	27.804	3 000	4 500	1.040	
	120	35	1.1	100	1.0	NA4917	100.0	220.0	26.346	2 800	4 300	1.310	
	120	63	1.1	100	1.0	NA6917	143.0	415.0	49.698	2 800	4 300	2.430	
90	120	26	1.0	100	1.5	NKI90/26	75.0	153.0	18.322	2 800	4 300	0.780	
	120	36	1.0	100	1.5	NKI90/36	108.0	245.0	29.340	2 800	4 300	1.080	
	125	35	1.1	105	1.0	NA4918	104.0	236.0	27.888	2 600	4 000	1.370	
	125	63	1.1	105	1.0	NA6918	160.0	405.0	47.859	2 600	4 000	2.640	
95	125	26	1.0	105	1.5	NKI95/26	50.0	129.0	15.244	2 600	4 000	0.935	
	125	36	1.0	105	1.5	NKI95/36	69.5	196.0	23.161	2 600	4 000	1.300	
	130	35	1.1	110	1.0	NA4919	106.0	245.0	28.563	2 400	3 800	1.430	
	130	63	1.1	110	1.0	NA6919	150.0	455.0	53.046	2 400	3 800	2.670	

Needle roller bearings with inner ring NKI, NKIS, NA48, NA49, NA69

d = 100 - 180 mm

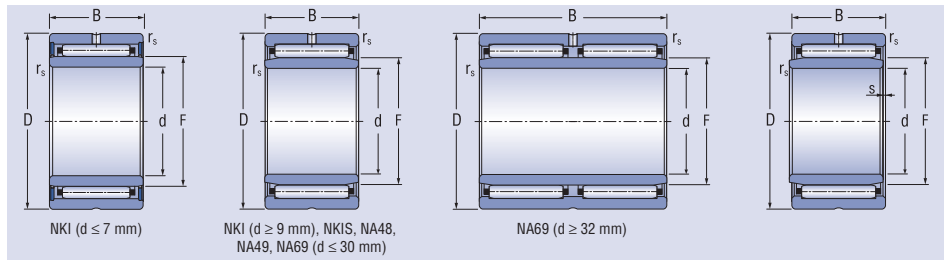

Dimensions						Designation	Basic load ratings		Fatigue load limit	Limiting speeds for lubrication with		Mass
d	D	B	r _s	F	s		dynamic	static		grease	oil	
mm						C _r	C _{0r}	C _u			kg	
100	130	30	1.1	110	1.5	NKI100/30	93.0	208.0	24.249	2 400	3 800	0.984
	130	40	1.1	110	2.0	NKI100/40	122.0	290.0	33.809	2 400	3 800	1.410
	135	32	1.1	115	1.5	NKIS100	95.0	216.0	24.839	2 200	3 600	1.340
	140	40	1.1	115	2.0	NA4920	127.0	285.0	32.705	2 200	3 600	2.010
110	140	30	1.0	120	2.0	NA4822	81.5	216.0	24.629	2 000	3 400	1.210
	150	40	1.1	125	0.8	NA4922	134.0	315.0	35.341	2 000	3 400	2.190
120	150	30	1.0	130	2.0	NA4824	85.0	236.0	26.305	1 900	3 200	1.310
	165	45	1.1	135	0.8	NA4924	160.0	380.0	41.614	1 800	3 000	3.040
130	165	35	1.1	145	1.5	NA4826	98.0	300.0	32.304	1 700	2 800	1.990
	180	50	1.5	150	1.0	NA4926	190.0	490.0	51.987	1 700	2 800	4.140
140	175	35	1.1	155	1.5	NA4828	102.0	315.0	33.297	1 600	2 600	2.120
	190	50	1.5	160	1.0	NA4928	193.0	520.0	54.177	1 600	2 600	4.410
150	190	40	1.1	165	1.5	NA4830	125.0	375.0	39.210	1 600	2 600	2.980
160	200	40	1.1	175	1.5	NA4832	139.0	390.0	39.740	1 500	2 400	3.150
170	215	45	1.1	185	1.5	NA4834	163.0	480.0	48.093	1 400	2 200	4.250
180	225	45	1.1	195	1.5	NA4836	166.0	510.0	50.315	1 400	2 200	4.480

Drawn cup needle roller bearings open / closed

Drawn cup needle roller bearings open / closed

Opened and closed drawn cup needle roller bearings are needle roller bearings with the smallest radial construction height consisting of a thin walled non-cutting outer rings and needle cages. Cage with needles allows rolling placing with high load capacity and also provides excellent function of the bearing even at high speeds and long lubrication intervals thanks to the large spaces for grease.

These drawn cup needle roller bearings, if not placed directly on the hardened shafts, may be combined with inner rings LR or IR. Inner rings belonging to specific bearings are indicated in the dimension tables.

Drawn cup needle roller bearings are supplied in these design:
 HK – opened drawn cup needle roller bearings with a cage
 BK – drawn cup needle roller bearings with a cage, one-side closed

In comparison with opened drawn cup needle roller bearings the closed drawn cup needle roller bearings type do have closed bottoms and are suitable to close the placing at the end of the shaft and to capture the start-up forces.

Main dimensions

Main dimensions of drawn cup needle roller bearings opened and drawn cup needle roller bearings closed, which are given by the dimensional tables, correspond to the international dimensional plan of ISO 3245

Designation

Designation of drawn cup needle roller bearings opened and drawn cup needle roller bearings closed in the main realization is given in dimensional tables.

Cages

Drawn cup needle roller bearings have steel cages, which are not specifically indicated. The smallest sizes and bearings for special applications are made with polyamide cages indicated by the added letters TV.

Sealing drawn cup needle roller bearings

Sealed drawn cup needle roller bearings have seals with a latch protecting the bearing from contaminants and retaining plastic lubricants under the normal operating conditions. They can be used under temperatures ranging from -30°C to +100°C. These bearings are always supplied filled with a suitable plastic lubricant.

The main dimensions and specification of drawn cup needle roller bearings in the RS and -2RS design are listed in the dimension tables.

Assembly tolerance

Thin walled outer rings of opened and closed drawn cup needle roller bearings made by non-cutting mechanical working become their final dimensional and shape accuracy only after being pressed into the body housing. Dimensional and shape accuracy of the hole is given by the position of shell circle and quality of placing when assembled. When respecting the tolerances of bodies given in the table, the shell circle of needle rollers at solid bodies in the tolerance field F8 gives with given tolerances of the shaft the normal operational clearance.

Material of the body (solid body)	Tolerance of the hole	Tolerance of the shaft without inner ring	with inner rings
steel or cast iron	N6 (N7)	h5 (h6)	k5 (j6)
light metal	R6 (R7)		

In case of less solid bodies there is a need to test and define by which tolerance of the shaft the required radial tolerance will be reached with.

Accuracy of shape of hole in the body must in IT 5 limits.

Deviations of width of the opened and closed drawn cup needle roller bearings are -0,2 mm.

Checking of dimensions of the opened and closed drawn cup needle roller bearings

Checking of dimensions of drawn cup needle roller bearings in not pressed state is not possible as the thin-walled ring may be imperfectly circular due to the production technology. Only after pressing into the hole of the body with recommended tolerances the bearing obtains its accuracy for its proper operation.

Dimensions can be checked as follows:

1. A bearing is pressed in a ring gauge (wall thickness ≥ 20 mm) with a bore according to the following table.
2. A testing pin is used to check that the inner diameter is within the relevant tolerance.

Internal diameter	External diameter	Ring gauge bore	Testing pin diameter	
		Nominal dimension	Upper deviation	Lower deviation
Fw	D			
mm	mm	mm	μm	μm
2	4.6	4.587	24	6
3	6.5	6.484	24	6
4	8	7.984	28	10
5	9	8.984	28	10
6	10	9.984	28	10
7	11	10.98	31	13
8	12	11.98	31	13
9	13	12.98	31	13
10	14	13.98	31	13
12	16	15.98	34	16
12	18	17.98	34	16
13	19	18.976	34	16
14	20	19.976	34	16
15	21	20.976	34	16
16	22	21.976	34	16
17	23	22.976	34	16
18	24	23.976	34	16
20	26	25.976	41	20
22	28	27.976	41	20
25	32	31.972	41	20
28	35	34.972	41	20
30	37	36.972	41	20
32	39	38.972	50	25
35	42	41.972	50	25
40	47	46.972	50	25
45	52	51.967	50	25
50	58	57.967	50	25
55	63	62.967	60	30
60	68	67.967	60	30

Misalignment

The admissible misalignment for drawn cup needle roller bearings fitted directly on tempered shafts or combined with inner LR or IR inner rings is very small. The admissible misalignment is up to 2'. The admissible misalignment depends on the internal bearing design, radial clearance during operation, and the forces and torque transmitted by the bearing. The quoted value is therefore approximate.

Dynamic equivalent radial load

$$P_r = F_r$$

Static equivalent radial load

$$P_{or} = F_r$$

Needle Cases HK, BK

d = 3 - 15 mm

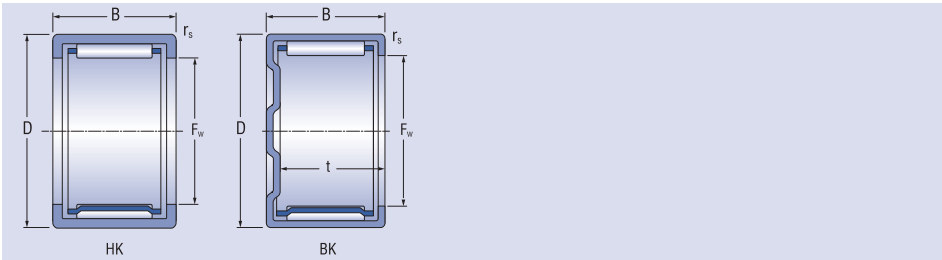

Dimensions						Designation	Basic load ratings		Fatigue load limit	Limiting speeds for lubrication with		Mass	Applicable inner rings	
d	F	D	B	t _{min}	r _{smin}		C _r	C _{0r}		C _u	grease		oil	IR
mm							kN			min ⁻¹	g			
3	3	6.5	6	-	0.3	HK0306TN	1.32	0.95	0.115	40 000	60 000	1.0	-	-
	3	6.5	6	5.2	0.3	BK0306TN	1.32	0.95	0.115	40 000	60 000	1.0	-	-
4	4	8	8	-	0.4	HK0408TN	1.76	1.37	0.167	32 000	48 000	1.6	-	-
	4	8	8	6.4	0.4	BK0408TN	1.76	1.37	0.167	32 000	48 000	1.8	-	-
5	5	9	9	-	0.4	HK0509	2.45	2.16	0.263	24 000	38 000	2.0	-	-
	5	9	9	7.4	0.4	BK0509	2.45	2.16	0.263	24 000	38 000	2.1	-	-
6	6	10	8	-	0.4	HK0608	2.28	2.04	0.248	20 000	34 000	2.1	-	-
	6	10	8	7.4	0.4	BK0608	2.28	2.04	0.248	20 000	34 000	2.2	-	-
	6	10	9	-	0.4	HK0609	3.05	2.9	0.353	20 000	34 000	2.2	-	-
	6	10	9	7.4	0.4	BK0609	3.05	2.9	0.353	20 000	34 000	2.6	-	-
7	7	11	9	-	0.4	HK0709	3.1	3.15	0.384	18 000	30 000	2.3	-	-
	7	11	9	7.4	0.4	BK0709	3.1	3.15	0.384	18 000	30 000	2.9	-	-
8	8	12	8	-	0.4	HK0808	2.8	2.85	0.347	16 000	26 000	2.7	-	-
	8	12	8	6.4	0.4	BK0808	2.8	2.85	0.347	16 000	26 000	3.0	-	-
	8	12	10	-	0.4	HK0810	3.8	4.15	0.506	16 000	26 000	3.0	IR5x8x12	-
	8	12	10	8.4	0.4	BK0810	3.8	4.15	0.506	16 000	26 000	3.4	IR5x8x12	-
9	9	13	10	-	0.4	HK0910	4.4	5.2	0.634	15 000	24 000	4.0	IR6x9x12	-
	9	13	10	8.4	0.4	BK0910	4.4	5.2	0.634	15 000	24 000	4.3	IR6x9x12	-
	9	13	12	-	0.4	HK0912	5.4	6.8	0.829	15 000	24 000	4.6	IR6x9x12	-
	9	13	12	10.4	0.4	BK0912	5.4	6.8	0.829	15 000	24 000	4.9	IR6x9x12	-
10	10	14	10	-	0.4	HK1010	4.55	5.7	0.695	14 000	22 000	4.1	IR7x10x10.5	-
	10	14	10	8.4	0.4	BK1010	4.55	5.7	0.695	14 000	22 000	4.3	IR7x10x10.5	-
	10	14	12	-	0.4	HK1012	5.6	7.35	0.896	14 000	22 000	4.8	IR7x10x12	-
	10	14	12	10.4	0.4	BK1012	5.6	7.35	0.896	14 000	22 000	5.0	IR7x10x12	-
	10	14	15	-	0.4	HK1015	7.1	10.0	1.219	14 000	22 000	6.0	IR7x10x16	-
	10	14	15	13.4	0.4	BK1015	7.1	10.0	1.219	14 000	22 000	6.2	IR7x10x16	-
12	12	16	10	-	0.4	HK1210	4.75	6.3	0.768	12 000	19 000	4.6	IR8x12x10.5	LR8x12x10.5
	12	16	10	8.4	0.4	BK1210	4.75	6.3	0.768	12 000	19 000	5.2	IR8x12x10.5	LR8x12x10.5
	12	18	12	-	1	HK1212	6.55	7.8	0.951	12 000	19 000	5.6	IR8x12x12.5	LR8x12x12.5
	12	18	12	9.3	1	BK1212	6.55	7.8	0.951	12 000	19 000	6.2	IR8x12x12.5	LR8x12x12.5
13	13	19	12	-	1	HK1312	6.8	8.5	1.036	11 000	18 000	8.9	IR10x13x12.5	LR10x13x12.5
	13	19	12	9.3	1	BK1312	6.8	8.5	1.036	11 000	18 000	11.2	IR10x13x12.5	LR10x13x12.5
14	14	20	12	-	1	HK1412	6.8	8.5	1.036	10 000	17 000	10.5	IR10x14x13	-
	14	20	12	9.3	1	BK1412	6.8	8.5	1.036	10 000	17 000	12.0	IR10x14x13	-
15	15	21	12	-	1	HK1512	7.5	9.8	1.195	9 500	16 000	11.1	IR12x15x12.5	LR12x15x12.5
	15	21	12	9.3	1	BK1512	7.5	9.8	1.195	9 500	16 000	12.7	IR12x15x12.5	LR12x15x12.5
	15	21	16	-	1	HK1516	10.2	14.6	1.780	9 500	16 000	15.0	IR12x15x16.5	LR12x15x16.5
	15	21	16	13.3	1	BK1516	10.2	14.6	1.780	9 500	16 000	16.5	IR12x15x16.5	LR12x15x16.5
	15	21	22	-	1	HK1522	12.9	19.6	2.390	9 500	16 000	20.4	IR12x15x22.5	LR12x15x22.5
	15	21	22	19.3	1	BK1522	12.9	19.6	2.390	9 500	16 000	22.0	IR12x15x22.5	LR12x15x22.5

Needle Cases HK, BK

d = 16 - 28 mm

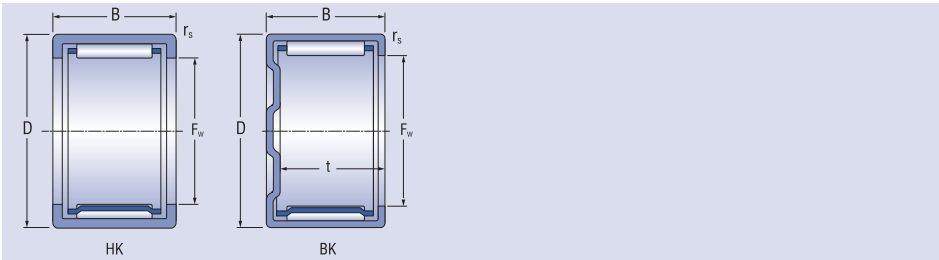

Dimensions						Designation	Basic load ratings		Fatigue load limit	Limiting speeds for lubrication with		Mass	Applicable inner rings	
d	F	D	B	t _{min}	r _{smin}		C _r	C _{0r}		C _u	grease		oil	g
mm						kN				min ⁻¹				
16	16	22	12	-	1	HK1612	7.35	9.8	1.195	9 500	16 000	11.7	IR12x16x13	-
	16	22	12	9.3	1	BK1612	7.35	9.8	1.195	9 500	16 000	13.8	IR12x16x13	-
	16	22	16	-	1	HK1616	10.2	15.0	1.829	9 500	16 000	15.8	IR12x16x16	-
	16	22	16	13.3	1	BK1616	10.2	15.0	1.829	9 500	16 000	17.6	IR12x16x16	-
	16	22	22	-	1	HK1622	12.7	19.6	2.390	9 500	16 000	21.7	IR12x16x22	-
16	22	22	19.3	1	BK1622	12.7	19.6	2.390	9 500	16 000	23.4	IR12x16x22	-	
17	17	23	12	-	1	HK1712	7.65	10.6	1.292	9 000	15 000	12.2	-	-
	17	23	12	9.3	1	BK1712	7.65	10.6	1.292	9 000	15 000	14.5	-	-
18	18	24	12	-	1	HK1812	8.0	11.2	1.365	9 000	15 000	13.1	IR15x18x12.5	-
	18	24	12	9.3	1	BK1812	8.0	11.2	1.365	9 000	15 000	14.9	IR15x18x12.5	-
	18	24	16	-	1	HK1816	11.0	17.0	2.073	9 000	15 000	17.5	IR15x18x16.5	-
	18	24	16	13.3	1	BK1816	11.0	17.0	2.073	9 000	15 000	19.9	IR15x18x16.5	-
20	20	26	12	-	1	HK2012	8.5	12.7	1.548	8 000	13 000	14.1	IR15x20x13	-
	20	26	12	9.3	1	BK2012	8.5	12.7	1.548	8 000	13 000	16.7	IR15x20x13	-
	20	26	16	-	1	HK2016	11.8	19.0	2.317	8 000	13 000	19.3	IR17x20x16.5	-
	20	26	16	13.3	1	BK2016	11.8	19.0	2.317	8 000	13 000	22.3	IR17x20x16.5	-
	20	26	20	-	1	HK2020	14.6	25.5	3.109	8 000	13 000	24.1	IR17x20x20.5	-
	20	26	20	17.3	1	BK2020	14.6	25.5	3.109	8 000	13 000	27.1	IR17x20x20.5	-
	20	26	30	-	1	HK2030	20.0	38.0	4.634	8 000	13 000	41.0	IR17x20x30.5	-
20	26	30	27.3	1	BK2030	20.0	38.0	4.634	8 000	13 000	43.0	IR17x20x30.5	-	
22	22	28	12	-	1	HK2212	8.65	13.4	1.634	7 500	12 000	15.0	IR17x22x13	-
	22	28	12	9.3	1	BK2212	8.65	13.4	1.634	7 500	12 000	18.1	IR17x22x13	-
	22	28	16	-	1	HK2216	12.5	21.2	2.585	7 500	12 000	20.9	IR17x22x16	-
	22	28	16	13.3	1	BK2216	12.5	21.2	2.585	7 500	12 000	24.3	IR17x22x16	-
	22	28	20	-	1	HK2220	14.6	25.5	3.109	7 500	12 000	26.2	IR17x22x23	-
22	28	20	17.3	1	BK2220	14.6	25.5	3.109	7 500	12 000	29.9	IR17x22x23	-	
25	25	32	12	-	1	HK2512	10.8	15.6	1.902	6 700	10 000	20.0	IR20x25x12.5	-
	25	32	12	9.3	1	BK2512	10.8	15.6	1.902	6 700	10 000	23.2	IR20x25x12.5	-
	25	32	16	-	1	HK2516	15.6	25.0	3.048	6 700	10 000	27.3	IR20x25x17	-
	25	32	16	13.3	1	BK2516	15.6	25.0	3.048	6 700	10 000	31.0	IR20x25x17	-
	25	32	20	-	1	HK2520	19.6	34.0	4.146	6 700	10 000	34.1	IR20x25x20.5	-
	25	32	20	17.3	1	BK2520	19.6	34.0	4.146	6 700	10 000	38.7	IR20x25x20.5	-
	25	32	26	-	1	HK2526	23.6	43.0	5.243	6 700	10 000	44.8	IR20x25x26.5	-
	25	32	26	23.3	1	BK2526	23.6	43.0	5.243	6 700	10 000	49.0	IR20x25x26.5	-
	25	32	38	-	1	HK2538	33.5	68.0	8.292	6 700	10 000	64.7	IR20x25x38.5	-
25	32	38	35.3	1	BK2538	33.5	68.0	8.292	6 700	10 000	69.0	IR20x25x38.5	-	
28	28	35	16	-	1	HK2816	15.3	25.5	3.109	6 300	9 500	30.1	IR22x28x17	-
	28	35	16	13.3	1	BK2816	15.3	25.5	3.109	6 300	9 500	34.1	IR22x28x17	-
	28	35	20	-	1	HK2820	20.0	36.0	4.390	6 300	9 500	37.6	IR22x28x20.5	-
	28	35	20	17.3	1	BK2820	20.0	36.0	4.390	6 300	9 500	43.0	IR22x28x20.5	-

Needle Cases HK, BK

d = 30 - 50 mm

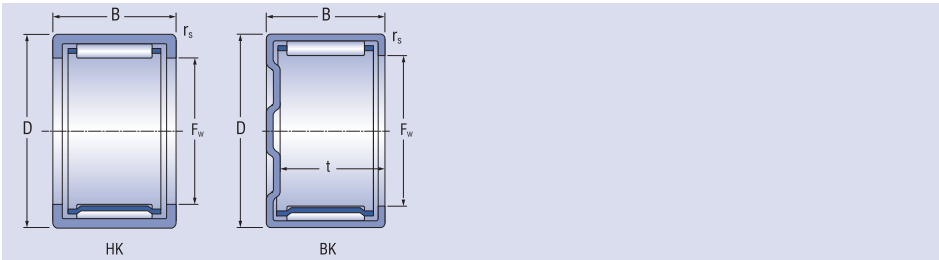

Dimensions						Designation	Basic load ratings		Fatigue load limit	Limiting speeds for lubrication with		Mass	Applicable inner rings	
d	F	D	B	t _{min}	r _{smin}		C _r	C _{0r}		C _u	grease		oil	IR
mm							kN			min ⁻¹	g			
30	30	37	12	-	1	HK3012	11.2	17.3	2.109	5 600	8 500	24.0	IR25x30x12.5	-
	30	37	12	9.3	1	BK3012	11.2	17.3	2.109	5 600	8 500	27.9	IR25x30x12.5	-
	30	37	16	-	1	HK3016	16.0	28.0	3.414	5 600	8 500	32.0	IR25x30x17	-
	30	37	16	13.3	1	BK3016	16.0	28.0	3.414	5 600	8 500	37.1	IR25x30x17	-
	30	37	20	-	1	HK3020	21.6	40.5	4.939	5 600	8 500	40.1	IR25x30x20.5	-
	30	37	20	17.3	1	BK3020	21.6	40.5	4.939	5 600	8 500	46.5	IR25x30x20.5	-
	30	37	26	-	1	HK3026	26.0	52.0	6.341	5 600	8 500	52.9	IR25x30x26.5	-
	30	37	26	23.3	1	BK3026	26.0	52.0	6.341	5 600	8 500	59.4	IR25x30x26.5	-
30	30	37	38	-	1	HK3038	36.5	81.5	9.939	5 600	8 500	76.1	IR25x30x38.5	-
	30	37	38	35.3	1	BK3038	36.5	81.5	9.939	5 600	8 500	82.5	IR25x30x38.5	-
35	35	42	12	-	1	HK3512	12.9	22.0	2.682	5 000	7 500	27.7	IR30x35x12.5	-
	35	42	12	9.3	1	BK3512	12.9	22.0	2.682	5 000	7 500	32.9	IR30x35x12.5	-
	35	42	16	-	1	HK3516	16.6	30.5	3.719	5 000	7 500	36.9	IR30x35x17	-
	35	42	16	13.3	1	BK3516	16.6	30.5	3.719	5 000	7 500	43.8	IR30x35x17	-
	35	42	20	-	1	HK3520	23.2	47.5	5.792	5 000	7 500	46.1	IR30x35x20.5	-
35	42	20	17.3	1	BK3520	23.2	47.5	5.792	5 000	7 500	54.8	IR30x35x20.5	-	
40	40	47	12	-	1	HK4012	12.9	23.2	2.829	4 500	6 700	31.1	IR35x40x12.5	-
	40	47	12	9.3	1	BK4012	12.9	23.2	2.829	4 500	6 700	38.2	IR35x40x12.5	-
	40	47	16	-	1	HK4016	18.0	35.5	4.329	4 500	6 700	41.4	IR35x40x17	-
	40	47	16	13.3	1	BK4016	18.0	35.5	4.329	4 500	6 700	51.0	IR35x40x17	-
	40	47	20	-	1	HK4020	24.0	51.0	6.219	4 500	6 700	51.8	IR35x40x20.5	-
40	47	20	17.3	1	BK4020	24.0	51.0	6.219	4 500	6 700	62.0	IR35x40x20.5	-	
45	45	52	16	-	1	HK4516	19.0	39.0	4.756	4 000	6 000	46.2	IR40x45x17	-
	45	52	16	13.3	1	BK4516	19.0	39.0	4.756	4 000	6 000	56.0	IR40x45x17	-
	45	52	20	-	1	HK4520	25.0	56.0	6.829	4 000	6 000	56.0	IR40x45x20.5	-
	45	52	20	17.3	1	BK4520	25.0	56.0	6.829	4 000	6 000	72.0	IR40x45x20.5	-
50	50	58	20	-	1	HK5020	27.5	57.0	6.951	3 600	5 300	72.0	IR45x50x20.5	-
	50	58	20	17.3	1	BK5020	27.5	57.0	6.951	3 600	5 300	87.3	IR45x50x20.5	-
	50	58	25	-	1	HK5025	33.5	75.0	9.146	3 600	5 300	90.1	IR45x50x25.5	-
	50	58	25	22.3	1	BK5025	33.5	75.0	9.146	3 600	5 300	109.0	IR45x50x25.5	-

Needle case with seal RS and 2 RS

d = 8 - 28 mm

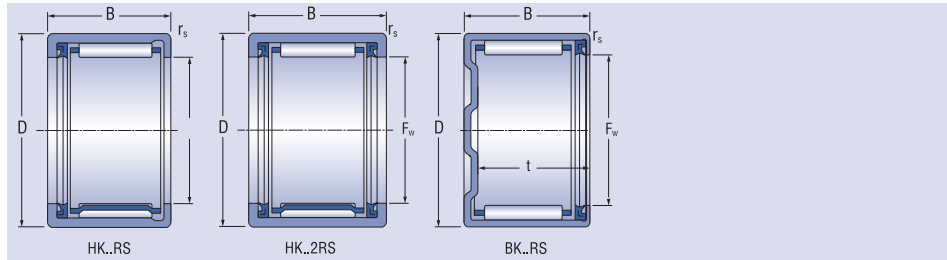

Dimensions						Designation	Basic load ratings		Fatigue load limit	Limiting speeds for lubrication with grease	Mass	Applicable inner rings	
d	F _w	D	B	t	r _{smin}		C _r	C _{0r}				C _u	min ⁻¹
mm						kN							
8	8	12	10	-	0.4	HK0810RS	2.3	2.1	0.256	14 000	2.9	IR5x8x12	-
	8	12	12	-	0.4	HK0812-2RS	2.3	2.1	0.256	14 000	3.4	IR5x8x16	-
10	10	14	12	-	0.4	HK1012RS	4.1	5.0	0.609	13 000	4.2	IR7x10x16	-
	10	14	14	-	0.4	HK1014-2RS	4.1	5.0	0.609	13 000	5.2	IR7x10x16	-
12	12	18	14	-	0.4	HK1214RS	6.1	7.0	0.853	12 000	10.7	IR8x12x12.5	LR8x12x12.5
	12	18	16	-	1	HK1216-2RS	6.1	7.0	0.853	12 000	11.5	IR8x12x16	-
14	14	20	14	-	1	HK1414RS	6.1	7.5	0.914	11 000	12.0	IR10x14x16	-
	14	20	14	11.3	1	BK1414RS	6.1	7.5	0.914	11 000	14.1	IR10x14x16	-
	14	20	16	-	1	HK1416-2RS	6.1	7.5	0.914	11 000	14.0	IR10x14x20	-
15	15	21	14	-	1	HK1514RS	6.8	8.8	1.073	11 000	12.6	IR12x15x16.5	-
	15	21	14	11.3	1	BK1514RS	6.8	8.8	1.073	11 000	14.4	12x15x16.5	-
	15	21	16	-	1	HK1516-2RS	6.8	8.8	1.073	11 000	14.3	IR12x15x16.5	LR12x15x16.5
	15	21	18	-	1	HK1518RS	9.5	11.4	1.390	11 000	16.0	-	-
	15	21	20	-	1	HK1520-2RS	9.5	11.4	1.390	11 000	22.0	IR12x15x22.5	LR12x15x22.5
16	16	22	14	-	1	HK1614RS	7.2	9.2	1.121	10 000	15.1	IR12x16x16	-
	16	22	14	11.3	1	BK1614RS	7.2	9.2	1.121	10 000	15.3	IR12x16x13	-
	16	22	16	-	1	HK1616-2RS	7.2	9.2	1.121	10 000	15.1	IR12x16x16.5	-
	16	22	20	-	1	HK1620-2RS	9.9	12.3	1.500	10 000	16.8	IR12x16x20	-
	16	22	25	-	1	HK1625-2RS	9.9	12.3	1.500	10 000	19.4	-	-
18	18	24	14	-	1	HK1814RS	7.8	9.9	1.207	9 500	15.1	IR15x18x16.5	-
	18	24	16	-	1	HK1816-2RS	7.8	9.9	1.207	9 500	17.0	IR15x18x16.5	-
20	20	26	12	-	1	HK2012-2RS	9.5	11.9	1.451	9 000	11.7	-	-
	20	26	16	-	1	HK2016-2RS	8.0	10.1	1.231	9 000	18.8	IR17x20x16.5	-
	20	26	18	-	1	HK2018 RS	12.7	20.1	2.451	9 000	21.4	IR17x20x20.5	-
	20	26	18	15.3	1	BK2018 RS	12.7	20.1	2.451	9 000	24.4	IR17x20x16.5	-
	20	26	20	-	1	HK2020-2RS	12.7	20.1	2.451	9 000	23.5	IR17x20x20.5	-
22	22	28	12	-	1	HK2212 RS	8.3	10.0	1.219	7 500	14.0	-	-
	22	28	14	-	1	HK2214 RS	9.0	12.4	1.512	7 500	18.3	IR17x22x16	-
	22	28	16	-	1	HK2216-2RS	9.0	12.4	1.512	7 500	20.3	IR17x22x16	-
	22	28	18	15.3	1	HK2218 RS	10.4	20.1	2.451	7 500	23.5	IR17x22x20.5	-
	22	28	20	-	1	HK2220-2RS	10.4	20.1	2.451	7 500	25.5	IR17x22x20.5	-
25	25	32	16	-	1	HK2516-2RS	9.8	13.2	1.609	6 700	27.3	IR20x25x17	-
	25	32	18	-	1	HK2518 RS	13.6	20.0	2.439	6 700	31.0	IR20x25x20	-
	25	32	18	15.3	1	BK2518 RS	13.6	20.0	2.439	6 700	35.3	IR20x25x20	-
	25	32	20	-	1	HK2520-2RS	13.6	20.0	2.439	6 700	33.1	IR20x25x20.5	-
	25	32	24	-	1	HK2524-2RS	17.9	30.0	3.658	6 700	39.7	-	-
	25	32	30	-	1	HK2530-2RS	24.5	43.0	5.243	6 700	47.3	IR20x25x30	-
28	28	35	20	-	1	HK2820-2RS	11.4	22.5	2.743	6 300	36.9	IR22x28x20.5	-

Needle case with seal RS and 2 RS

d = 30 - 50 mm

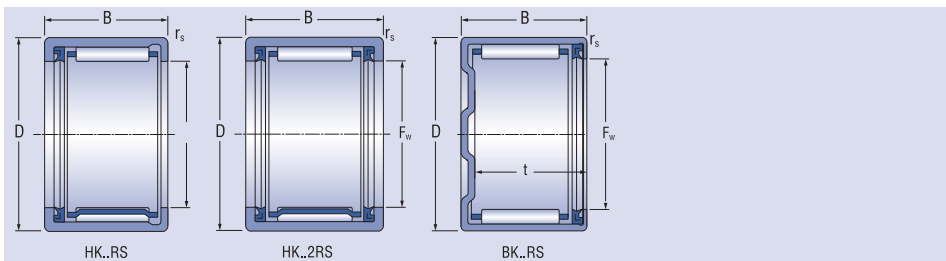

Dimensions		Designation		Basic load ratings		Fatigue load limit	Limiting speeds for lubrication with grease	Mass	Applicable inner rings				
d	F _w	D	B	t	r _{smin}				C _r	C _{0r}	C _u	IR	LR
mm						kN							
30	30	37	16	–	1	HK3016-2RS	10.1	16.2	1.975	5 600	28.5	IR25x30x17	–
	30	37	18	–	1	HK3018 RS	16.2	26.0	3.170	5 600	36.6	IR25x30x20.5	–
	30	37	20	–	1	HK3020-2RS	16.2	26.0	3.170	5 600	39.1	IR25x30x20.5	–
	30	37	24	–	1	HK3024-2RS	21.0	38.5	4.695	5 600	49.7	–	–
35	35	42	16	–	1	HK3516-2RS	10.1	20.3	2.475	5 000	36.4	IR30x35x17	–
	35	42	18	–	1	HK3518 RS	16.7	30.5	3.719	5 000	37.4	IR30x35x20.5	–
	35	42	20	–	1	HK3520-2RS	16.7	30.5	3.719	5 000	41.1	IR30x35x20.5	–
40	40	47	16	–	1	HK4016-2RS	11.0	21.3	2.597	4 500	41.2	IR35x40x17	–
	40	47	18	–	1	HK4018 RS	19.0	30.5	3.719	4 500	47.3	IR35x40x20.5	–
	40	47	20	–	1	HK4020-2RS	19.0	30.5	3.719	4 500	50.2	IR35x40x20.5	–
45	45	52	18	–	1	HK4518 RS	20.3	41.0	5.000	4 000	54.2	IR40x45x20.5	–
	45	52	20	–	1	HK4520-2RS	20.3	41.0	5.000	4 000	57.4	IR40x45x20.5	–
50	50	58	22	–	1	HK5022 RS	30.0	61.0	7.439	3 600	77.2	IR45x50x25.5	–
	50	58	24	–	1	HK5024-2RS	30.0	61.0	7.439	3 600	84.0	IR45x50x25.5	–

Inner rings

Inner rings

Inner rings are made from hardened rolling bearing steel and have precision machined or ground raceways.

They are used where:

- the shaft cannot be used as a raceway for needle roller and cage assemblies, drawn cup needle roller bearings with open ends, drawn cup needle roller bearings with closed end and needle roller bearings
- needle roller bearings must be combined with wider inner rings in order to allow larger axial displacements of the shaft in relation to the housing
- optimum running surfaces are required for seal lips.

Inner rings are supplied in following designs:

Inner ring IR – normal accuracy, according to the DIN 620
Inner ring LR – with higher tolerances, see dimensional tables

Inner rings IR

Inner rings IR have a precision machined raceway. Chamfers on the end faces allow easy insertion into the bearing and prevent damage to the seal lips of the bearing. Inner rings are available with and without a lubrication hole.

Inner rings LR

Inner rings LR have a ground raceway. The end faces are turned and the edges are broken. These rings have larger tolerances than the rings IR. They are thus suitable for applications that allow larger width tolerances and less demanding requirements for axial runout.

Inner rings

d = 5 - 22 mm

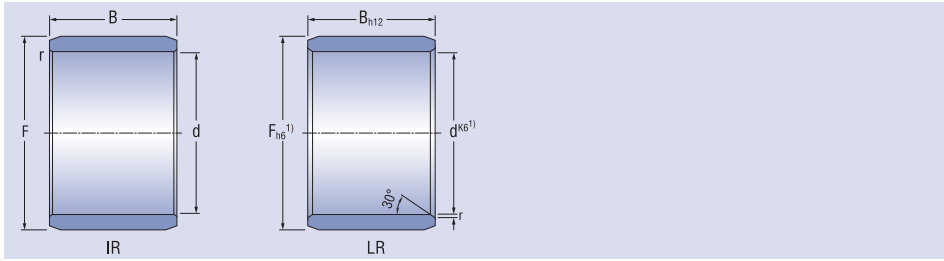

Dimensions				Inner ring designation	Mass	
d	F	D	r _s min			
mm					g	
5	8	12	0.3	IR5x8x12	2.8	
	8	16	0.3	IR5x8x16	3.7	
6	9	12	0.3	IR6x9x12	3.2	
	9	16	0.3	IR6x9x16	4.3	
	10	10	0.3	IR6x10x10	3.7	
	10	12	0.3	• IR6x10x12	4.6	
7	10	10.5	0.3	IR7x10x10.5	3.1	
	10	12	0.3	IR7x10x12	3.6	
	10	16	0.3	IR7x10x16	4.9	
8	12	10	0.3	IR8x12x10	4.8	
	12	10.5	0.3	IR/LR8x12x10.5	5.0	
	12	12	0.3	IR8x12x12	5.7	
	12	12.5	0.3	IR8x12x12.5	5.9	
9	12	12	0.3	IR9x12x12	4.5	
	12	16	0.3	IR9x12x16	6.1	
10	13	12.5	0.3	IR/LR10x13x12.5	5.2	
	14	12	0.3	° IR10x14x12	7.3	
	14	13	0.3	IR10x14x13	7.4	
	14	14	0.3	• IR10x14x14	8.0	
	14	16	0.3	IR10x14x16	9.2	
	14	20	0.3	IR10x14x20	11.6	
12	15	12	0.3	IR12x15x12	5.8	
	15	12.5	0.3	IR12x15x12.5	6.1	
	15	16	0.3	IR12x15x16	8.0	
	15	16.5	0.3	IR/LR12x15x16.5	8.1	
	15	22.5	0.3	IR/LR12x15x22.5	11.0	
	16	12	0.3	° IR12x16x12	7.9	
	16	13	0.3	IR12x16x13	8.7	
	16	14	0.3	• IR12x16x14	9.5	
	16	16	0.3	IR12x16x16	11.0	
	16	20	0.3	IR12x16x20	13.5	
14	17	17	0.3	IR14x17x17	10.0	
15	18	12.5	0.3	IR15x18x12.5	7.2	
	18	16	0.3	IR15x18x16	9.6	
	18	16.5	0.3	IR15x18x16.5	9.9	
	19	16	0.3	IR15x19x16	12.8	
	19	20	0.3	IR15x15x20	16.4	
	20	12	0.3	° IR15x20x12	12.1	
	20	13	0.3	IR15x20x13	13.5	
	20	14	0.3	• IR15x20x14	14.7	
	20	23	0.3	IR15x20x23	24.4	

Dimensions				Inner ring designation	Mass	
d	F	D	r _s min			
mm					g	
17	20	16	0.3	IR17x20x16	10.7	
	20	16.5	0.3	IR17x20x16.5	11.1	
	20	20	0.3	IR17x20x20	13.5	
	20	20.5	0.3	IR17x20x20.5	13.8	
	20	30.5	0.3	IR17x20x30.5	20.6	
	21	16	0.3	IR17x21x16	14.3	
	21	20	0.3	IR17x21x20	18.0	
	22	13	0.3	IR17x22x13	14.9	
	22	14	0.3	• IR17x22x14	16.4	
	22	16	0.3	IR17x22x16	18.7	
	22	23	0.3	IR17x22x23	27.1	
	24	20	0.3	IR17x24x20	33.6	
20	24	16	0.3	IR20x24x16	16.5	
	24	20	0.3	IR20x24x20	21.3	
	25	12.5	0.3	IR20x25x12.5	20.0	
	25	17	0.3	IR20x25x17	22.4	
	25	18	0.3	IR20x25x18	24.3	
	25	20	0.3	IR20x25x20	27.5	
	25	20.5	0.3	IR20x25x20.5	28.2	
22	26	16	0.3	IR22x26x16	17.5	
	26	20	0.3	IR22x26x20	23.2	
	28	17	0.3	IR22x28x17	29.8	
	28	20	0.3	IR22x28x20	35.0	
	28	20.5	0.3	IR22x28x20.5	36.0	
25	29	20	0.3	IR25x29x20	25.5	
	29	30	0.3	IR25x29x30	39.3	
	30	12.5	0.3	IR25x30x12.5	20.0	
	30	15.5	0.3	IR25x30x15.5	23.2	
	30	16.5	0.3	IR25x30x16.5	26.7	
	30	17	0.3	• IR25x30x17	27.5	
	30	18	0.3	IR25x30x18	29.8	
	30	20	0.3	IR25x30x20	32.6	
	30	20.5	0.3	IR25x30x20.5	33.5	
	30	26.5	0.3	IR25x30x26.5	43.3	
	30	30	0.3	IR25x30x30	50.1	
	30	32	0.3	IR25x30x32	53.0	
30	38.5	0.3	IR25x30x38.5	63.8		

Inner rings

d = 30 - 45 mm

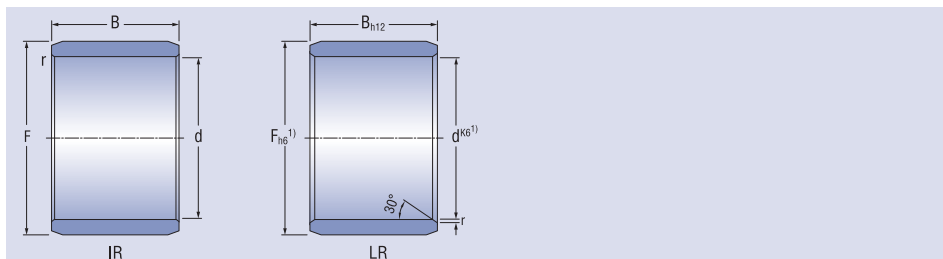

Dimensions				Inner ring designation	Mass	
d	F	D	r _s min			
mm					g	
30	35	12.5	0.3	IR30x35x12.5	23.3	
	35	13	0.3	IR30x35x13	25.0	
	35	16	0.3	IR30x35x16	30.8	
	35	17	0.3	IR30x35x17	32.3	
	35	18	0.3	• IR30x35x18	35.3	
	35	20	0.3	IR30x35x20	40.0	
	35	20.5	0.3	IR30x35x20.5	40.7	
	35	26	0.3	IR30x35x26	50.3	
	35	30	0.3	IR30x35x30	58.9	
35	40	12.5	0.3	IR35x40x12.5	27.2	
	40	16.5	0.3	IR35x40x16.5	37.4	
	40	17	0.3	IR35x40x17	38.4	
	40	20	0.3	IR35x40x20	44.4	
	40	20.5	0.3	IR35x40x20.5	46.1	
	40	30	0.3	IR35x40x30	67.9	
40	45	16.5	0.3	IR40x45x16.5	41.4	
	45	17	0.3	IR40x45x17	42.5	
	45	20	0.3	IR40x45x20	50.5	
	45	20.5	0.3	IR40x45x20.5	52.5	
	45	30	0.3	IR40x45x30	77.1	
45	50	20.5	0.3	IR45x50x20	57.0	
	50	25.5	0.3	IR45x50x25.5	75.1	
	50	35	0.3	IR45x50x35	101.0	

° with lubrication hole

• with lubrication hole without counterbore

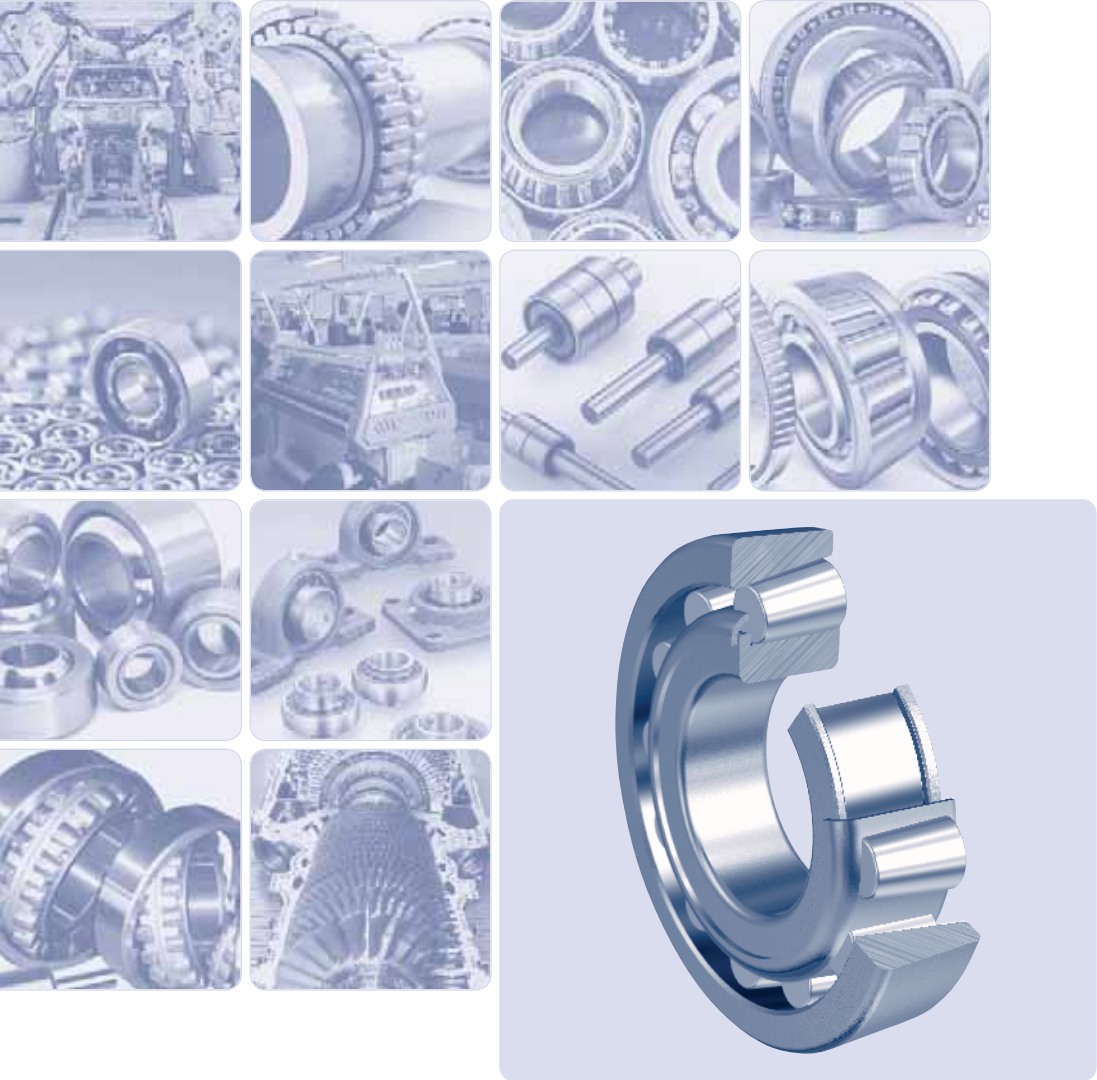

Single Row Tapered Roller Bearings

Single Row Tapered Roller Bearings

Single Row Tapered Roller Bearings

The single row tapered roller bearings have one row of tapered rollers resting on the guiding rib of the inner ring with their functional faces. Due to the great number of tapered rollers, these bearings have a high load rating capacity in the radial as well as axial directions. The axial load carrying capacity depends on the contact angle magnitude. The arrangement with single row tapered roller bearings is usually formed by a bearing pair. A single bearing can carry the axial load only in one direction. The bearings are separable. The inner ring (cone) with tapered rollers and a cage is one assembly unit. The outer ring (cup) is the other assembly unit.

The single row tapered roller bearings are manufactured in metric dimensions as well as in inch dimensions.

Boundary Dimensions

The boundary dimensions of metric single row tapered roller bearings indicated in the dimension tables correspond to the international dimensional standard ISO 355.

The boundary dimensions of inch single row tapered roller bearings indicated in the dimension tables correspond to the American standard AFBMA Standard 19.2 (USA).

Designation

The designation of standard design bearings is given in the table part of this publication. The additional mark X used on the 320 series bearings means, that the main dimensions are changed in accordance with the recommendations of the international standards ISO.

The differences of the basic design are indicated by additional symbols according to designation system indicated in section 2.2.

Cage

The single row tapered roller bearings are equipped with a pressed steel cage which is not marked.

Tolerances

The bearings are commonly produced in normal tolerance class P0 which is not indicated.

Internal Clearance

The single row tapered roller bearings are usually mounted in pairs, in which required clearance, or preload are adjusted when mounting. Clearance or preload magnitude is determined according to the requirements on arrangements.

Misalignment

The seating surfaces for single row tapered roller bearings must be coaxial, aligned only with small deviations, because the admissible ring misalignment is very small. Under common operating conditions the misalignment is

- under low load ($F_r < 0.1C_{0r}$) 1' to 1.5'
- under high load ($F_r \geq 0.1C_{0r}$) 2' to 4'

Radial Equivalent Dynamic and Static Load

The calculation methods are defined in the ISO 281 (dynamic load) and ISO 76 (static load) norm.

Single Row Tapered Roller Bearings

d = 15 - 40 mm

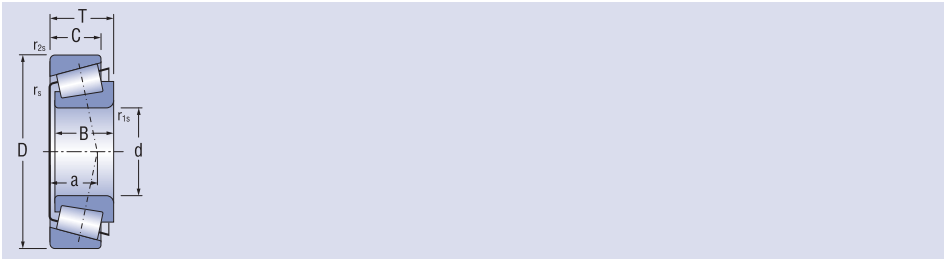

Dimensions								Bearing designation	Basic load rating		Fatigue load limit	Limiting speed for lubrication with		Mass
d	D	B	C	T	r1s	r2s	a ≈		dynamic	static		grease	oil	
mm								Cr	Cor	Cu	min ⁻¹			
15	35	11	10	11.75	0.6	0.6	8.3	30202A	16.6	15.5	1.9	10 000	14 000	0.053
	42	13	11	14.25	0.6	0.6	9.5	30302A	22.9	21.6	2.6	9 500	12 000	0.094
17	40	12	11	13.25	1.0	1.0	9.9	30203A	20.7	21.9	2.7	10 000	14 000	0.079
	47	14	12	15.25	1.0	1.0	10.4	30303A	28.3	27.2	3.3	9 200	12 000	0.133
20	42	15	12	15.00	0.6	0.6	10.3	32004AX	25.0	28.2	3.4	9 400	13 000	0.095
	47	14	12	15.25	1.0	1.0	11.2	30204A	28.2	30.6	3.7	8 700	12 000	0.127
	47	18	15	19.25	1.0	1.0	12.8	32204A	32.5	34.8	4.2	8 700	12 000	0.156
	52	15	13	16.25	1.5	1.5	11.1	30304A	33.1	33.2	4.0	8 300	11 000	0.179
25	52	21	18	22.25	1.5	1.5	13.6	32304A	42.7	46.3	5.3	7 500	9 500	0.230
	47	15	11.5	15.00	0.6	0.6	11.6	32005AX	28.0	34.0	4.1	8 000	11 000	0.110
	52	15	13	16.25	1.0	1.0	12.5	30205A	32.2	37.0	4.5	7 500	10 000	0.153
	52	18	16	19.25	1.0	1.0	13.9	32205A	39.8	44.8	5.5	7 900	11 000	0.188
	52	22	18	22.00	1.0	1.0	14.0	33205A	47.1	55.8	6.8	7 300	9 800	0.217
	62	17	15	18.25	1.5	1.5	13.0	30305A	46.9	48.1	5.9	6 700	9 000	0.263
30	62	17	13	18.25	1.5	1.5	20.1	31305A	40.7	46.1	5.7	5 600	7 500	0.260
	62	24	20	25.25	1.5	1.5	15.9	32305A	61.6	68.8	8.4	6 000	8 000	0.365
	55	17	13	17.00	1.0	1.0	13.3	32006AX	35.8	46.8	5.7	6 700	9 000	0.173
	62	16	14	17.25	1.0	1.0	13.8	30206A	43.3	50.5	6.1	6 300	8 500	0.231
	62	20	17	21.25	1.0	1.0	15.6	32206A	51.8	63.7	7.8	6 300	8 400	0.286
	62	25	19.5	25.00	1.0	1.0	15.7	33206A	63.8	75.4	9.1	5 600	7 500	0.347
	72	19	16	20.75	1.5	1.5	15.3	30306A	59.0	63.1	7.7	5 600	7 500	0.387
35	72	19	14	20.75	1.5	1.5	23.1	31306A	52.5	60.4	7.4	5 000	6 700	0.389
	72	27	23	28.75	1.5	1.5	18.9	32306A	81.6	96.4	11.2	5 300	7 000	0.562
	62	18	14	18.00	1.0	1.0	15.1	32007AX	48.2	57.9	7.1	6 000	8 000	0.224
	72	17	15	18.25	1.5	1.5	15.3	30207A	54.2	63.5	7.7	5 300	7 000	0.332
	72	23	19	24.25	1.5	1.5	17.9	32207A	70.6	89.5	10.9	5 300	7 000	0.447
	72	28	22	28.00	1.5	1.5	18.2	33207A	82.6	101.7	12.0	5 500	7 400	0.515
	80	21	18	22.75	2.0	1.5	16.8	30307A	75.3	82.6	10.1	5 000	6 700	0.515
40	80	21	15	22.75	2.0	1.5	25.8	31307A	65.1	76.8	9.4	4 500	6 000	0.508
	80	31	25	32.75	2.0	1.5	20.4	32307A	99.0	118.3	14.0	4 800	6 300	0.752
	68	19	14.5	19.00	1.0	1.0	14.9	32008AX	51.9	71.1	8.6	5 300	7 100	0.268
	80	18	16	19.75	1.5	1.5	16.9	30208A	63.0	74.0	9.0	4 800	6 300	0.422
	80	23	19	24.75	1.5	1.5	18.9	32208A	77.9	97.2	11.4	4 800	6 300	0.531
	80	32	25	32.00	1.5	1.5	20.8	33208A	105.8	135.5	16.2	4 300	5 600	0.715
90	23	20	25.25	2.0	1.5	19.5	30308A	90.9	107.8	12.7	4 500	6 000	0.748	
	23	17	25.25	2.0	1.5	29.0	31308A	81.4	96.4	11.2	4 000	5 300	0.727	
	33	27	35.25	2.0	1.5	23.3	32308A	115.7	147.8	17.8	4 400	5 900	1.040	

Single Row Tapered Roller Bearings

d = 45 - 60 mm

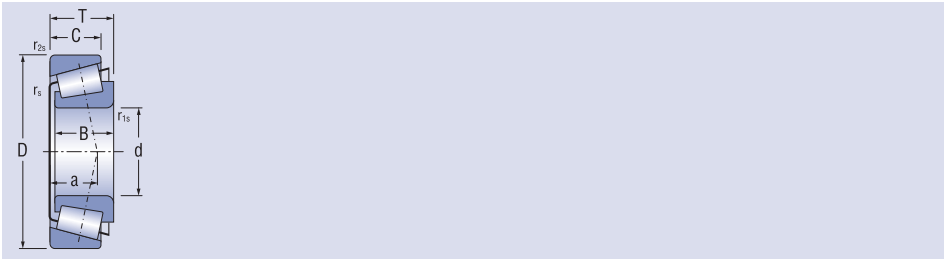

Dimensions								Bearing designation	Basic load rating		Fatigue load limit	Limiting speed for lubrication with		Mass
d	D	B	C	T	r1s	r2s	a ≈		dynamic	static		grease	oil	
mm								Cr	Cor	Cu	min ⁻¹		kg	
45	75	20	16	20.00	1.0	1.0	16.5	32009AX	58.4	81.4	9.9	4 800	6 400	0.337
	80	26	20	26.00	1.5	1.5	19.1	33109A	87.1	117.2	14.4	4 600	6 200	0.535
	85	19	16	20.75	1.5	1.5	18.6	30209A	67.9	83.6	10.1	4 500	6 000	0.474
	85	23	19	24.75	1.5	1.5	20.1	32209A	80.7	104.0	12.6	4 500	6 000	0.573
	85	32	25	32.00	1.5	1.5	21.9	33209A	109.5	145.1	18.0	4 000	5 300	0.771
	100	25	22	27.25	2.0	1.5	21.3	30309A	108.9	129.8	15.4	4 000	5 300	0.983
	100	25	18	27.25	2.0	1.5	31.7	31309A	95.6	113.8	14.2	3 400	4 500	0.950
	100	36	30	38.25	2.0	1.5	25.6	32309A	145.3	189.4	23.0	4 000	5 300	1.400
50	80	20	15.5	20.00	1.0	1.0	17.8	32010AX	61.1	89.0	11.1	4 400	5 800	0.365
	80	24	19	24.00	1.0	1.0	17.0	33010A	76.8	110.9	13.5	4 500	5 600	0.433
	85	26	20	26.00	1.5	1.5	20.4	33110A	89.3	124.1	14.6	4 300	5 300	0.572
	90	20	17	21.75	1.5	1.5	20.0	30210A	73.3	92.0	11.5	4 300	5 600	0.529
	90	23	19	24.75	1.5	1.5	21.0	32210A	82.0	107.0	12.6	4 300	5 600	0.626
	90	32	24.5	32.00	1.5	1.5	23.2	33210A	112.9	154.6	19.0	4 300	5 700	0.825
	110	27	23	29.25	2.0	1.5	23.0	30310A	130.0	157.0	18.9	3 600	4 800	1.280
	110	27	19	29.25	2.0	1.5	34.8	31310A	108.0	128.5	15.8	3 200	4 300	1.214
	110	40	33	42.25	2.0	1.5	28.2	32310A	177.5	236.1	28.4	3 600	4 800	1.890
55	90	23	17.5	23.00	1.5	1.5	19.8	32011AX	80.2	117.2	14.1	4 000	5 400	0.551
	90	27	21	27.00	1.5	1.5	19.0	33011A	94.9	144.7	17.4	4 000	5 000	0.651
	100	21	18	22.75	2.0	1.5	21.0	30211A	90.8	113.7	14.2	3 800	5 000	0.713
	100	25	21	26.75	2.0	1.5	22.8	32211A	108.0	142.3	17.8	3 800	5 000	0.854
	100	35	27	35.00	2.0	1.5	25.1	33211A	143.1	196.7	23.7	3 400	4 500	1.153
	120	29	25	31.50	2.5	2.0	24.9	30311A	153.3	187.6	23.2	3 200	4 300	1.630
	120	29	21	31.50	2.5	2.0	37.5	31311A	130.0	158.0	19.7	2 800	3 800	1.560
	120	43	35	45.50	2.5	2.0	30.4	32311A	203.0	271.4	32.8	3 300	4 400	2.377
60	95	23	17.5	23.00	1.5	1.5	20.9	32012AX	81.7	122.2	15.4	3 700	4 900	0.584
	95	27	21	27.00	1.5	1.5	19.8	33012A	96.7	151.1	18.3	3 700	4 900	0.684
	100	30	23	30.00	1.5	1.5	23.1	33112A	117.1	173.2	20.9	3 600	4 500	0.895
	110	22	19	23.75	1.5	1.5	22.3	30212A	103.3	130.0	15.5	3 400	4 500	0.905
	110	28	24	29.75	1.5	1.5	25.0	32212A	133.0	179.0	22.1	3 000	4 500	1.170
	110	38	29	38.00	2.0	1.5	27.5	33212A	165.8	231.4	28.9	3 600	4 700	1.570
	130	31	26	33.50	2.0	1.5	26.6	30312A	171.4	210.0	25.7	3 000	4 000	1.990
	130	31	22	33.50	2.0	1.5	40.1	31312A	145.4	176.8	21.3	2 700	3 700	1.900
	130	46	37	48.50	2.0	1.5	32.0	32312A	226.7	303.0	37.2	3 000	4 000	2.900

Single Row Tapered Roller Bearings

d = 65 - 80 mm

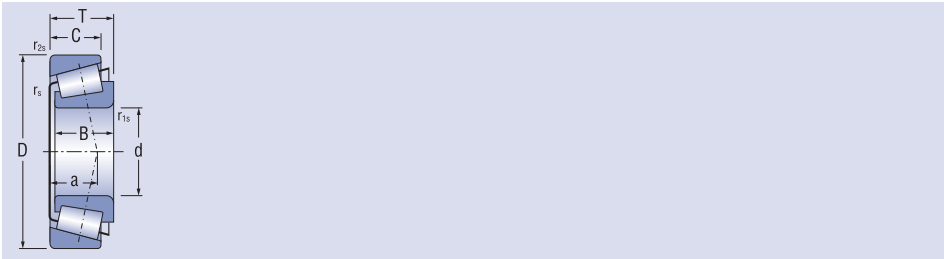

Dimensions								Bearing designation	Basic load rating		Fatigue load limit	Limiting speed for lubrication with		Mass
d	D	B	C	T	r1s	r2s	a ≈		dynamic	static		grease	oil	
mm								Cr	Cor	Cu	min ⁻¹	kg		
65	100	23	17.5	23.00	1.5	1.5	22.4	32013AX	82.8	127.3	15.5	3 400	4 600	0.621
	100	27	21	27.00	1.5	1.5	20.9	33013A	98.1	157.7	19.3	3 600	4 800	0.732
	110	34	26.5	34.00	1.5	1.5	26.0	33113A	142.8	220.4	26.5	3 400	4 300	1.300
	120	23	20	24.75	2.0	1.5	23.8	30213A	120.0	152.0	19.0	3 100	4 200	1.130
	120	31	27	32.75	2.0	1.5	27.3	32213A	160.9	221.7	26.6	3 000	4 200	1.544
	120	41	32	41.00	2.0	1.5	29.5	33213A	202.2	281.6	34.8	3 100	4 200	1.980
	140	33	28	36.00	3.0	2.5	28.7	30313A	195.9	241.7	29.6	2 600	3 600	2.440
	140	33	23	36.00	3.0	2.5	44.2	31313A	165.7	202.6	25.0	2 200	3 200	2.370
140	48	39	51.00	3.0	2.5	34.3	32313A	259.6	349.8	42.1	2 800	3 700	3.514	
70	110	25	19	25.00	1.5	1.5	23.8	32014AX	104.0	160.0	19.6	3 200	4 200	0.830
	110	31	25.5	31.00	1.5	1.5	22.0	33014A	134.4	220.4	27.5	3 400	4 300	1.070
	120	37	29	37.00	2.0	1.5	28.2	33114A	172.1	267.0	32.6	3 200	4 000	1.700
	125	24	21	26.25	2.0	1.5	25.8	30214A	132.3	173.6	21.7	2 900	3 900	1.259
	125	31	27	33.25	2.0	1.5	28.8	32214A	168.5	237.1	29.2	2 900	3 800	1.640
	125	41	32	41.00	2.0	1.5	30.7	33214A	208.6	298.3	36.3	3 000	3 800	2.100
	150	35	30	38.00	3.0	2.5	30.7	30314A	219.0	271.7	32.4	2 400	3 400	2.985
	150	35	25	38.00	3.0	2.5	46.8	31314A	187.0	231.0	27.2	2 000	3 000	2.867
150	51	42	54.00	3.0	2.5	36.5	32314A	298.9	408.5	48.0	2 600	3 500	4.342	
75	115	25	19	25.00	1.5	1.5	25.2	32015AX	104.0	160.0	19.0	3 000	4 000	0.877
	115	31	25.5	31.00	1.5	1.5	22.8	33015A	133.1	221.2	27.5	3 200	4 000	1.120
	125	37	29	37.00	2.0	1.5	29.4	33115A	176.1	280.0	34.4	2 900	3 900	1.800
	130	25	22	27.25	2.0	1.5	27.4	30215A	138.4	185.4	22.5	2 700	3 600	1.361
	130	31	27	33.25	2.0	1.5	30.0	32215A	170.3	242.1	29.8	2 700	3 600	1.740
	130	41	31	41.00	2.0	1.5	31.9	33215A	207.1	299.7	36.1	2 900	3 900	2.167
	160	37	31	40.00	3.0	2.5	32.0	30315A	252.8	318.8	36.6	2 000	3 200	3.570
	160	37	26	40.00	3.0	2.5	49.7	31315A	208.5	258.9	30.1	2 100	2 900	3.470
160	55	45	58.00	3.0	2.5	39.4	32315A	347.4	483.1	56.2	2 400	3 200	5.373	
80	125	29	22	29.00	1.5	1.5	26.8	32016AX	141.0	220.0	26.5	2 800	3 700	1.270
	125	36	29.5	36.00	1.5	1.5	25.2	33016A	181.9	304.3	36.7	3 000	3 800	1.630
	130	37	29	37.00	2.0	1.5	30.7	33116A	179.6	292.3	35.1	2 800	3 800	1.930
	140	26	22	28.25	2.5	2.0	28.1	30216A	160.4	212.8	25.0	2 500	3 400	1.670
	140	33	28	25.25	2.5	2.0	31.4	32216A	198.1	279.0	33.3	2 500	3 400	2.130
	140	46	35	46.00	2.5	2.0	35.1	33216A	245.7	361.8	43.1	2 600	3 400	2.830
	170	39	33	42.50	3.0	2.0	34.4	30316A	278.8	352.5	40.9	1 900	3 000	4.175
	170	39	27	42.50	3.0	2.0	52.8	31316A	229.8	287.1	33.2	2 000	2 800	4.120
170	58	48	61.50	3.0	2.0	42.1	32316A	388.0	543.1	60.8	2 200	3 000	6.380	

Single Row Tapered Roller Bearings

d = 85 - 105 mm

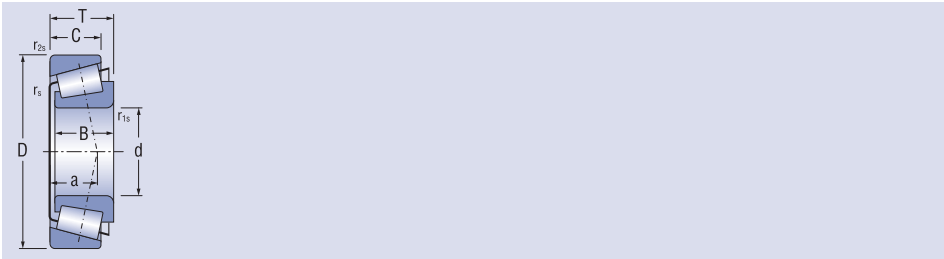

Dimensions								Bearing designation	Basic load rating		Fatigue load limit	Limiting speed for lubrication with grease	Limiting speed for lubrication with oil		Mass
d	D	B	C	T	r1s	r2s	a ≈		Cr	Cor			Cu	min ⁻¹	
mm	mm	mm	mm	mm	mm	mm	mm	kN	kN	kN					
85	130	29	22	29.00	1.5	1.5	28.1	32017AX	139.8	220.3	26.6	2 600	3 500	1.316	
	130	36	29.5	36.00	1.5	1.5	26.2	33017A	180.4	305.5	36.4	2 800	3 600	1.690	
	140	41	32	41.00	2.5	2.0	33.1	33117A	216.0	354.0	41.4	2 600	3 500	2.427	
	150	28	24	30.50	2.5	2.0	30.3	30217A	177.6	236.8	27.4	2 400	3 200	2.060	
	150	36	30	38.50	2.5	2.0	33.9	32217A	226.7	324.0	37.9	2 400	3 200	2.680	
	150	49	37	49.00	2.5	2.0	36.9	33217A	281.7	415.7	48.7	2 400	3 200	3.520	
	180	41	34	44.50	4.0	3.0	35.9	30317A	304.9	388.2	42.6	1 900	2 800	4.966	
	180	41	28	44.50	4.0	3.0	55.6	31317A	253.9	319.1	37.0	1 900	2 600	4.708	
180	60	49	63.50	4.0	3.0	43.5	32317A	422.0	592.8	67.2	2 000	2 800	7.310		
90	140	32	24	32.00	2.0	1.5	30.0	32018AX	171.3	271.0	31.8	2 500	3 300	1.720	
	140	39	32.5	39.00	2.0	1.5	27.6	33018A	232.6	388.6	45.2	2 500	3 300	2.180	
	150	45	35	45.00	2.5	2.0	34.9	33118A	252.1	414.7	47.4	2 600	3 400	3.131	
	160	30	26	32.50	2.5	2.0	32.3	30218A	200.1	269.6	31.2	2 200	3 000	2.539	
	160	40	34	42.50	2.5	2.0	36.8	32218A	269.0	395.0	44.5	2 200	3 000	3.440	
	160	55	42	55.00	2.5	2.0	40.8	33218A	330.6	499.7	58.1	2 200	3 000	4.550	
	190	43	36	46.50	4.0	3.0	37.5	30318A	342.1	440.9	48.1	1 800	2 700	5.800	
	190	43	30	46.50	4.0	3.0	58.5	31318A	281.7	357.1	40.2	1 700	2 400	5.474	
190	64	53	67.50	4.0	3.0	46.2	32318A	478.3	683.3	71.7	1 900	2 600	8.810		
95	145	32	24	32.00	2.0	1.5	31.4	32019AX	174.6	281.3	32.0	2 300	3 100	1.794	
	145	39	32.5	39.00	2.0	1.5	28.4	33019A	231.0	389.9	44.5	2 300	3 100	2.270	
	170	32	27	34.50	3.0	2.5	34.2	30219A	226.6	309.0	34.1	2 100	2 800	3.040	
	170	43	37	45.50	3.0	2.5	39.2	32219A	302.5	448.4	50.3	2 100	2 800	4.236	
	170	58	44	58.00	3.0	2.5	42.7	33219A	377.4	568.4	65.7	2 000	2 800	5.480	
	200	45	38	49.50	4.0	3.0	40.0	30319A	370.0	477.7	52.5	1 700	2 600	6.809	
	200	45	32	49.50	4.0	3.0	61.2	31319A	311.4	400.0	43.0	1 700	2 400	6.460	
	200	67	55	71.50	4.0	3.0	49.0	32319A	516.1	737.7	77.4	1 800	2 400	10.10	
100	150	32	24	32.00	2.0	1.5	32.8	32020AX	173.1	281.7	32.4	2 200	3 000	1.850	
	150	39	32.5	39.00	2.0	1.5	29.1	33020A	229.5	391.2	45.0	2 200	3 000	2.330	
	180	34	29	37.00	3.0	2.5	36.4	30220A	253.9	350.3	38.5	2 000	2 700	3.714	
	180	46	39	49.00	3.0	2.5	41.9	32220A	341.0	512.0	56.9	2 000	2 700	5.110	
	180	63	48	63.00	3.0	2.5	45.5	33220A	436.5	666.2	76.6	2 000	2 700	6.725	
	215	47	39	51.50	4.0	3.0	42.0	30320A	406.4	526.4	57.2	1 600	2 500	8.164	
	215	51	35	56.50	4.0	3.0	68.4	31320A	372.9	488.2	52.4	1 600	2 200	8.614	
	215	73	60	77.50	4.0	3.0	52.9	32320A	600.1	872.2	101.1	1 600	2 000	13.00	
105	160	35	26	35.00	2.5	2.0	34.6	32021AX	205.0	335.0	37.8	2 100	2 800	2.400	
	160	43	34	43.00	2.5	2.0	30.8	33021A	257.4	437.4	49.1	2 200	3 000	2.967	
	190	36	30	39.00	3.0	2.5	38.5	30221A	285.3	398.6	43.3	1 900	2 500	4.383	
	190	50	43	53.00	3.0	2.5	45.0	32221A	381.0	579.2	63.0	1 900	2 500	6.276	
	225	49	41	53.50	4.0	3.0	43.3	30321A	432.0	562.0	65.1	1 500	2 400	9.380	
	225	53	36	58.00	4.0	3.0	70.2	31321A	398.0	525.0	56.5	1 500	2 000	9.580	
	225	77	63	81.50	4.0	3.0	56	32321A	646.4	955.6	109.3	1 500	1 900	14.80	

Single Row Tapered Roller Bearings

d = 110 - 160 mm

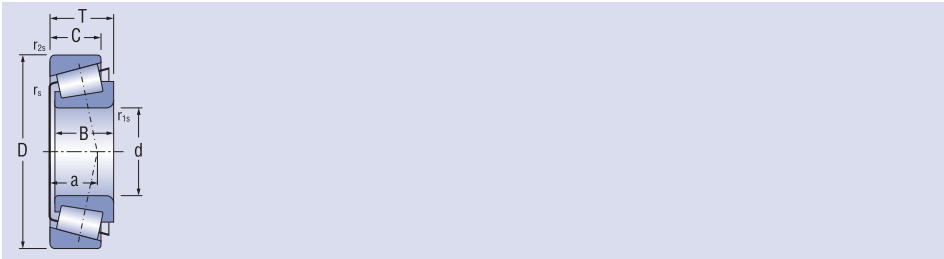

Dimensions								Bearing designation	Basic load rating		Fatigue load limit	Limiting speed for lubrication with		Mass	
d	D	B	C	T	r _{1s}	r _{2s}	a [≈]		C _r	C _{0r}		C _u	grease		oil
mm												min ⁻¹			
110	170	38	29	38.00	2.5	2.0	36.6	32022AX	245.7	403.4	44.5		2 000	2 700	3.017
	170	47	37	47.00	2.5	2.0	33.2	33022A	288.7	502.7	55.1		2 100	2 800	3.810
	200	38	32	41.00	3.0	2.5	40.4	30222A	314.9	443.6	47.4		1 800	2 400	5.203
	200	53	46	56.00	3.0	2.5	47.3	32222A	431.7	666.3	70.9		1 800	2 400	7.412
	240	50	42	54.50	4.0	3.0	45.1	30322A	472.0	585.0	67.2		1 400	2 300	11.00
	240	57	38	63.00	4.0	3.0	74.8	31322A	458.0	581.0	66.8		1 400	1 800	12.10
	240	80	65	84.50	4.0	3.0	58	32322A	722.8	1 076.0	118.4		1 400	1 800	17.80
120	180	38	29	38.00	2.5	2.0	39.3	32024AX	242.1	404.4	43.3		1 800	2 500	3.180
	215	40	34	43.50	3.0	2.5	44.1	30224A	337.4	483.3	50.3		1 600	2 300	6.192
	215	58	50	61.50	3.0	2.5	52.3	32224A	477.7	758.1	79.8		1 700	2 200	9.267
	260	55	46	59.50	4.0	3.0	50.0	30324A	562.0	715.0	78.6		1 300	2 200	14.20
	260	62	42	68.00	4.0	3.0	81.7	31324A	535.0	695.0	77.2		1 300	1 700	15.30
	260	86	69	90.50	4.0	3.0	61.6	32324A	825.8	1 226.2	137.0		1 300	1 700	22.10
130	200	45	34	45.00	2.5	2.0	43.3	32026AX	335.0	558.0	58.7		1 700	2 300	4.940
	230	40	34	43.75	4.0	3.0	46.1	30226A	366.0	521.4	53.2		1 500	2 200	6.954
	230	64	54	67.75	4.0	3.0	56.6	32226A	552.0	888.0	96.4		1 600	2 000	11.40
	280	58	49	67.75	5.0	4.0	52.8	30326A	620.0	755.0	83.0		1 200	2 100	17.30
	280	66	44	72.00	5.0	4.0	87.1	31326A	592.0	805.0	88.5		1 100	1 500	18.40
140	210	45	34	45.00	2.5	2.0	46.0	32028AX	330.0	568.0	58.8		1 600	2 200	5.150
	250	42	36	45.75	4.0	3.0	49.0	30228A	409.2	584.7	58.5		1 400	2 000	8.748
	250	68	58	71.75	4.0	3.0	60.7	32228A	645.0	1 050.0	110.4		1 500	1 800	14.40
	300	62	53	67.75	5.0	4.0	55.7	30328A	722.0	975.0	103.7		1 100	2 000	21.40
	300	70	47	77.00	5.0	4.0	92.9	31328A	678.0	928.0	97.7		1 000	1 400	22.80
150	225	48	36	48.00	3.0	2.5	49.2	32030AX	368.0	635.0	65.1		1 500	2 000	6.250
	270	45	38	49.00	4.0	3.0	52.4	30230A	451.2	645.9	63.1		1 300	1 800	10.818
	270	73	60	77.00	4.0	3.0	65.4	32230A	720.0	1 182.0	130.0		1 100	1 500	18.20
160	240	51	38	51	3.0	2.5	52.6	32032AX	419.6	734.5	71.6		1 400	1 900	7.653
	290	80	67	84.00	4.0	3.0	70.9	32232A	857.0	1 436.5	136.6		1 050	1 800	23.170

Single Row Tapered Roller Bearings in inch sizes

d = 15.875 - 44.450 mm
d = 0.6250 - 1.7500 inch

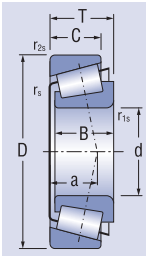

Dimensions						Bearing designation	Basic load rating		Fatigue load limit	Dimensions mounting rounding		Mass	
d	D	B	C	T	a [≈]		dynamic	static		r _{1s}	r _{2s}		
mm/inch						C _r	C _{0r}	min ⁻¹	mm/inch				
15.875 0.6250	42.863 1.6875	14.288 0.5625	9.525 0.3750	14.288 0.5625	13.0 0.5118	K-11590/ K-11520	17.3 3 889	18.6 4 181	2.3 517	1.5 0.059	1.5 0.059	0.063 0.14	
16.000 0.6299	47.000 1.8504	21.000 0.8268	16.000 0.6299	21.000 0.8268	14.9 0.5866	K-HM81649/ K-HM81610	36.9 8 295	40.6 9 127	5.0 1 124	1.0 0.039	2.0 0.079	0.199 0.439	
17.462 0.6875	39.878 1.5700	14.605 0.5750	10.670 0.4201	13.843 0.5450	8.7 0.3425	K-LM11749/ K-LM11710	22.9 5 160	23.4 5 260	2.8 629	1.27 0.05	1.27 0.05	0.081 0.18	
19.050 0.7500	45.237 1.7810	16.637 0.6550	12.065 0.4750	15.494 0.6100	9.5 0.3740	K-LM11949/ K-LM11910	25.6 5 755	26.6 5 980	3.2 719	1.27 0.05	1.27 0.05	0.124 0.27	
21.986 0.8656	45.237 1.7810	16.637 0.6550	12.065 0.4750	15.494 0.6100	10.0 0.3937	K-LM12749/ K-LM12710	28.7 6 452	29.9 6 722	3.6 809	1.27 0.05	1.27 0.05	0.116 0.26	
25.400 1.0000	50.292 1.9800	14.732 0.5800	10.668 0.4200	14.224 0.5600	10.9 0.4291	K-L44643/ K-L44610	24.6 5 530	28.7 6 452	3.5 787	1.27 0.05	1.27 0.05	0.125 0.27	
26.988 1.0625	50.292 1.9800	14.732 0.5800	10.668 0.4200	14.224 0.5600	10.9 0.4291	K-L44649/ K-L44610	24.6 5 530	28.7 6 452	3.5 787	3.68 0.14	1.27 0.05	0.115 0.25	
29.000 1.1417	50.292 1.9800	14.732 0.5800	10.668 0.4200	14.224 0.5600	10.8 0.4251	K-L45449/ K-L45410	25.6 5 755	33.5 7 531	4.1 922	3.68 0.14	1.27 0.05	0.114 0.25	
30.162 1.1875	64.292 2.5312	21.433 0.8438	16.670 0.6563	21.433 0.8438	17.7 0.6968	K-M86649/ K-M86610	44.7 10 050	59.6 13 400	7.3 1 641	1.57 0.0618	1.57 0.0618	0.341 0.75	
31.750 1.2500	59.131 2.3280	16.764 0.6600	11.811 0.4650	15.875 0.6250	12.6 0.4960	K-LM67048/ K-LM67010	31.6 7 104	38.3 8 610	4.7 1 056	4.75 0.1870	1.27 0.05	0.179 0.41	
31.750 1.2500	62.000 2.4409	19.050 0.7500	14.288 0.5625	18.161 0.7150	13.3 0.5236	K-15123/ K-15245	46.8 10 500	53.9 12 100	6.5 1 461	4.75 0.1870	2.5 0.1	0.243 0.51	
34.925 1.3750	65.088 2.5625	18.288 0.7200	13.970 0.5500	18.034 0.7100	14.1 0.5551	K-LM48548/ K-LM48510	43.0 9 667	53.1 11 937	6.5 1 461	4.75 0.1870	1.27 0.05	0.249 0.55	
34.925 1.3750	73.025 2.8750	24.608 0.9688	19.050 0.7500	23.813 0.9375	15.7 0.6181	PLC65-3	57.3 12 882	76.4 17 175	9.3 2 091	3.56 0.1402	2.36 0.0929	0.495 1.09	
35.000 1.3780	60.000 2.3622	16.764 0.6600	11.938 0.4700	15.875 0.6250	13.2 0.5196	K-L68149/ K-L68111	31.6 7 104	42.2 9 487	5.1 1 146	4.75 0.1870	1.27 0.05	0.174 0.40	
38.000 1.4961	63.000 2.4803	17.000 0.6693	13.500 0.5315	17.100 0.6793	14.6 0.5748	K-JL69349/ K-JL69310	43.5 9 600	58.2 13 100	7.1 1 596	1.5 0.0591	1.27 0.05	0.196 0.43	
38.100 1.5000	65.088 2.5625	18.288 0.7200	13.970 0.5500	18.034 0.7100	13.7 0.5393	K-LM29749 K-LM29710	49.2 11 061	60.7 13 646	7.4 1 663	2.30 0.0906	1.10 0.0433	0.240 0.53	
39.688 1.5625	80.167 3.1562	30.391 1.1965	29.370 1.1563	29.370 1.1563	18.4 0.7244	K-3386/ K-3320	81.0 18 210	104.0 23 380	13.0 2 922	0.80 0.031	3.20 0.126	0.704 1.55	
40.000 1.5787	80.000 3.1496	22.403 0.8820	17.826 0.7018	21.000 0.8268	14.5 0.5708	K-344A/ K-322	70.8 15 916	73.6 16 546	9.0 2 023	0.80 0.031	1.30 0.051	0.514 1.14	
40.100 1.5787	67.975 2.6762	18.000 0.7087	13.500 0.5315	17.500 0.6890	13.9 0.5472	K-LM300849/ K-LM300811	47.3 10 633	59.6 13 400	7.3 1 641	3.60 0.142	1.50 0.059	0.230 0.51	
44.450 1.7500	83.058 3.2700	25.400 1.0000	19.050 0.7500	23.813 0.9375	17.6 0.6929	K-25580/ K-25521	59.6 13 400	87.4 19 650	11.0 2 473	5.23 0.20	2.5 0.1	0.572 1.21	

Single Row Tapered Roller Bearings in inch sizes

d = 45.242 - 146.050 mm
d = 1.7812 - 5.7500 inch

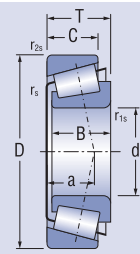

Dimensions						Bearing designation	Basic load rating		Fatigue load limit	Dimensions mounting rounding		Mass	
d	D	B	C	T	a [≈]		C _r	C _{0r}		r _{1s}	r _{2s}		
mm/inch								min ⁻¹	mm/inch				
45.242 1.7812	77.788 3.0625	19.842 0.7812	15.800 0.6220	19.842 0.7812	17.2 0.6771	K-LM603049/ K-LM603011	59.6 13 400	77.9 17 513	9.5 2 136	1.0 0.039	1.0 0.039	0.378 0.84	
50.000 1.9685	82.000 3.2283	21.500 0.8465	17.000 0.6693	21.500 0.8465	16.1 0.6338	K-JLM104948/ K-JLM104910	75.2 16 906	104.0 23 380	13.0 2 922	3.0 0.118	0.5 0.020	0.410 0.91	
50.800 2.0000	101.600 4.0000	36.068 1.4200	29.988 1.1806	34.925 1.3750	22.1 0.8700	K-529/ K-522	123.0 27 652	162.0 36 420	20.2 4 541	0.80 0.031	3.20 0.126	1.22 2.69	
57.150 2.2500	127.000 5.0000	44.450 1.7500	34.925 1.3750	44.450 1.7500	35.0 1.3779	K-65225/ K-65500	228.0 51 256	276.0 62 047	34.5 7 756	3.5 0.138	3.3 0.130	2.79 6.15	
65.000 2.5591	110.000 4.3307	28.000 1.1024	22.500 0.8858	28.000 1.1024	24.5 0.9645	K-JM511946/ K-JM511910	133.0 29 900	188.0 42 264	23.5 5 283	3.0 0.118	2.5 0.098	1.05 2.32	
75.000 2.9528	115.000 4.5276	25.000 0.9843	19.000 0.7480	25.000 0.9843	25.3 0.9960	K-JLM714149/ K-JLM714110	104.0 23 380	158.0 35 520	19.7 4 429	5.0 0.197	2.5 0.098	0.955 2.11	
88.900 3.5000	152.400 6.0000	39.688 1.5625	30.162 1.1875	39.688 1.5625	33.1 1.3031	K-HM518445/ K-HM518410	230.0 51 706	344.0 77 334	42.4 9 532	6.4 0.252	3.3 0.130	2.88 6.35	
89.974 3.5423	146.975 5.7864	40.000 1.5748	32.500 1.2795	40.000 1.5748	30.8 1.2125	K-HM218248/ K-HM218210	243.0 54 630	365.0 82 055	44.5 10 004	7.0 0.276	3.5 0.138	2.59 5.71	
90.000 3.5433	145.000 5.7087	34.000 1.3386	27.000 1.0630	35.000 1.3780	33.0 1.2992	K-JM718149/ K-JM718110	213.0 47 884	315.0 70 815	38.8 8 722	6.0 0.236	2.5 0.098	2.15 4.74	
146.050 5.7500	193.675 7.6250	28.575 1.1250	23.020 0.9063	28.575 1.1250	33.5 1.3189	K-36691/ K-36620	181.0 40 690	390.0 87 675	44.5 10 004	5.8 0.228	1.5 0.059	2.31 5.10	

Dimensional Tolerances

Δd = +0,013 mm / +0,00051 inch
 ΔD = +0,025 mm / +0,00098 inch
 ΔT = +0,200 mm / +0,00787 inch



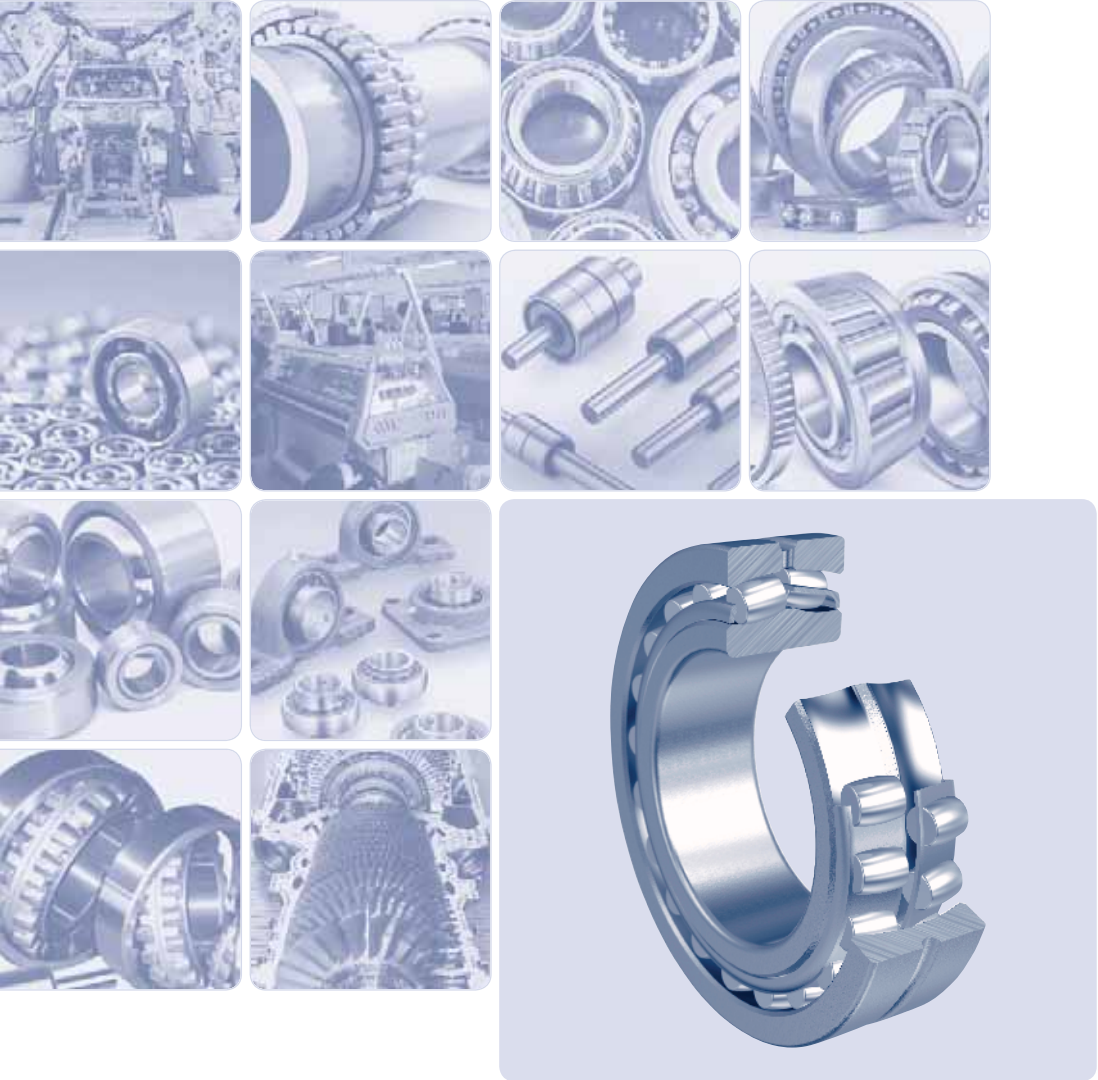

Double - Row Spherical Roller Bearings

Double - Row Spherical Roller Bearings

Double - Row Spherical Roller Bearings

Double-row spherical roller bearings are capable of capturing heavy radial load with simultaneous axial load in both directions.

Large number of long, symmetrical barrels of a large diameter arranged in two rows with a common spherical raceway on the outer ring are typical for these bearings.

The spherical shape of the raceway on the outer ring permits angular misalignment of the rings during operation and thus ensures even distribution of load on the rolling elements even with small shaft tilt or axial misalignment of the ring surfaces. These unique parameters help spherical roller bearings achieving:

- Lower operating temperatures and higher revolutions,
- Transmission of greater axial load,
- Longer lifespan.

Double-row spherical roller bearings are used in particular for installation of rollers in rolling mills, in gearboxes, in axles of rail vehicles, etc.

Double-row spherical roller bearings are difficult to dismantle and therefore are installed as a single unit.

Main dimensions

The main dimensions of double-row spherical-roller bearings are specified in the dimension tables and they correspond to the international ISO 15 dimension requirements.

Designation

The designation of bearings in the basic design is indicated in the dimension tables. The difference from the basic design is indicated by additional symbols.

Tapered bore

Double-row spherical roller bearings are produced with a cylindrical or tapered bore – tapering 1:12 is indicated by the symbol “K”. Tapering 1:30 indicated by the symbol “K30” is available for the 240 and 241 series. Bearings with a tapered bore are mounted directly on a tapered shaft or on a cylindrical shaft using fastening or tightening sleeves in accordance with ISO 113 and ISO 2982-1,2. Designation of adapter sleeve or withdrawal sleeve belonging to individual bearings with tapered hole are stated in dimension tables.

Groove and lubrication holes on the outer ring

Double-row spherical roller bearings are designed with a groove and three lubrication holes on the outer ring (W33) for delivering lubricant directly to the bearing between the two rows or barrels. This helps to achieve better lubrication of bearings and consequently greater reliability in operation. Deliveries of bearings without the groove and lubrication holes need to be discussed in advance.

Bearing construction

The internal structure of double-row spherical roller bearings uses symmetrical barrels with several modifications depending on the cage type.

CC the bearings have an inner ring without guide rings and with one free centre ring placed between the two rows of barrels. The guide ring is centred on the inner ring including two cages moulded from a steel band.

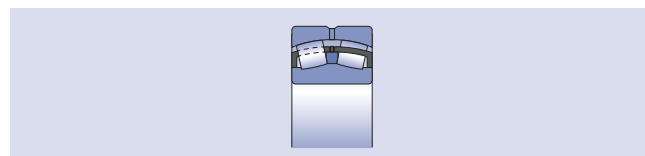

CA the bearings have guide rings on the inner ring. A single-piece double ridge solid brass cage is guided on the inner ring. The hole diameter in the 213 series is $d \leq 100$ mm, in the 222 series the hole diameter is $d \leq 110$ mm, and in the 223 series with the hole diameter $d \leq 90$ mm, the cage is guided on rolling elements.

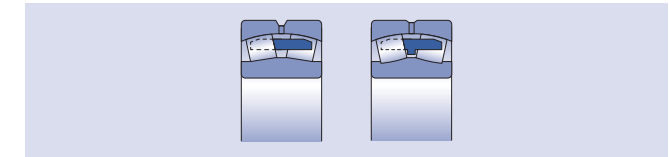

MB the bearings have guide rings on the inner ring and two double ridge solid brass cages guided on a fixed central ring.

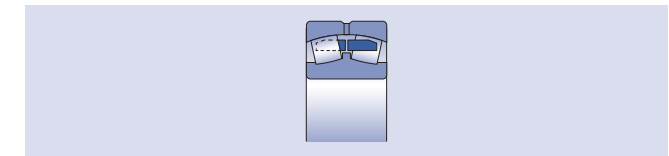

Precision

Double-row spherical roller bearings are normally produced with the standard P0 precision grade (the P0 symbol is not stated). Deliveries of bearing with greater precision need to be discussed in advance.

Radial play

Commonly produced double-row spherical roller bearings have the standard radial play, which is not indicated. Bearings with reduced (C2) or increased (C3, C4, C5) radial play are available for special applications.

Stabilisation for operation at higher temperatures

Double-row spherical roller bearings are heat treated in standard production, allowing the application of bearings at operating temperatures up to 150 °C without any inadmissible changes in dimensions. The relevant additional symbol S0 is not indicated. Bearings with normal stabilisation up to 120 °C indicated with the S00 symbol or bearings with stabilisation from 150 °C to 400 °C (S1, S2, S3, S4 and S5) are available for special applications. Deliveries of these bearings needs to be discussed in advance.

Misalignment

Double-row spherical roller bearings can be tilted from the central position without disrupting their correct operation as shown by the values in the following table.

Admissible tilt	Bearing type
1°30'	222XX, 230XX, 231XX, 233XX, 239XX
2°	223XX, 240XX
2°30'	232XX, 241XX

The axial bearing capacity of bearings installed onto the clamping tapered-sleeve adapters

When installing two-row spherical-roller bearings onto the smooth shafts using the clamping tapered-sleeve adapters, the size of the axial load depends on the friction between the shaft and the tapered-sleeve adapter. For the properly installed bearings the acceptable axial load can be calculated as follows:

$$F_{ap} = 3Bd$$

F_{ap}	- maximum acceptable axial load	[N]
D	- width of the bearing	[mm]
d	- diameter of the bearing hole	[mm]

Equivalent dynamic and static loads

Equivalent dynamic load

If the radial bearing is subject to simultaneous radial and axial load of the constant magnitude and direction, the radial dynamic equivalent load is calculated as follows:

$$P_r = F_r + Y_1 F_a \quad \text{for } F_a/F_r \leq e$$

$$P_r = 0,67 V F_r + Y_2 F_a \quad \text{for } F_a/F_r > e$$

The e , Y_1 , Y_2 coefficient values for individual bearings are listed in the dimension tables.

Static equivalent radial load

$$P_{0r} = F_r + Y_0 \cdot F_a$$

The Y_0 coefficient values for individual bearings are listed in the dimension tables.

Limiting revolution frequency

The limiting revolution frequency values specified in the table annexes to the catalogue state the maximum number of revolutions under which the bearing runs trouble-free at a particular safety level under following operating conditions:

- bearing load corresponds to the service life $L_{10h} \approx 100.000$ hours,
- the magnitude of the axial forces F_a affecting a radial spherical-roller bearing reaches max. 25 % of the magnitude of the radial forces F_r ,
- bearings have been produced for the normal accuracy class with the normal radial clearance,
- revolution frequency limiting values specified for oil lubrication applies to oil-bath lubrication.

Radial clearance Spherical Roller Bearings with Cylindrical Bore

Bore diameter d		Clearance									
over	to	C2		normal		C3		C4		C5	
mm	mm	min.	max.	min.	max.	min.	max.	min.	max.	min.	max.
		µm									
24	30	15	25	25	40	40	55	55	75	75	95
30	40	15	30	30	45	45	60	60	80	80	100
40	50	20	35	35	55	55	75	75	100	100	125
50	65	20	40	40	65	65	90	90	120	120	150
65	80	30	50	50	80	80	110	110	145	145	180
80	100	35	60	60	100	100	135	135	180	180	225
100	120	40	75	75	120	120	160	160	210	210	260
120	140	50	95	95	145	145	190	190	240	240	300
140	160	60	110	110	170	170	220	220	280	280	350
160	180	65	120	120	180	180	240	240	310	310	390
180	200	70	130	130	200	200	260	260	340	340	430
200	225	80	140	140	220	220	290	290	380	380	470
225	250	90	150	150	240	240	320	320	420	420	520
250	280	100	170	170	260	260	350	350	460	460	570
280	315	110	190	190	280	280	370	370	500	500	630
315	355	120	200	200	310	310	410	410	550	550	690
355	400	130	220	220	340	340	450	450	600	600	760
400	450	140	240	240	370	370	500	500	660	660	820
450	500	140	260	260	410	410	550	550	720	720	900
500	560	150	280	280	440	440	600	600	780	780	1000
560	630	170	310	310	480	480	650	650	850	850	1100
630	710	190	350	350	530	530	700	700	920	920	1190
710	800	210	390	390	580	580	770	770	1010	1010	1300
800	900	230	430	430	650	650	860	860	1120	1120	1440

Radial clearance Spherical Roller Bearings with Tapered Bore

Bore diameter d		Clearance									
over	to	C2		normal		C3		C4		C5	
mm	mm	min.	max.	min.	max.	min.	max.	min.	max.	min.	max.
		µm									
24	30	20	30	30	40	40	55	55	75	-	-
30	40	25	35	35	50	50	65	65	85	85	105
40	50	30	45	45	60	60	80	80	100	100	130
50	65	40	55	55	75	75	95	95	120	120	160
65	80	50	70	70	95	95	120	120	150	150	200
80	100	55	80	80	110	110	140	140	180	180	230
100	120	65	100	100	135	135	170	170	220	220	280
120	140	80	120	120	160	160	200	200	260	260	330
140	160	90	130	130	180	180	230	230	300	300	380
160	180	100	140	140	200	200	260	260	340	340	430
180	200	110	160	160	220	220	290	290	370	370	470
200	225	120	180	180	250	250	320	320	410	410	520
225	250	140	200	200	270	270	350	350	450	450	570
250	280	150	220	220	300	300	390	390	490	490	620
280	315	170	240	240	330	330	430	430	540	540	680
315	355	190	270	270	360	360	470	470	590	590	740
355	400	210	300	300	400	400	520	520	650	650	820
400	450	230	330	330	440	440	570	570	720	720	910
450	500	260	370	370	490	490	630	630	790	790	1000
500	560	290	410	410	540	540	680	680	870	870	1100
560	630	320	460	460	600	600	760	760	980	980	1230
630	710	350	510	510	670	670	850	850	1090	1090	1360
710	800	390	570	570	750	750	960	960	1220	1220	1500
800	900	440	640	640	840	840	1070	1070	1370	1370	1690

Double - Row Spherical Roller Bearings

d = 20 - 50 mm

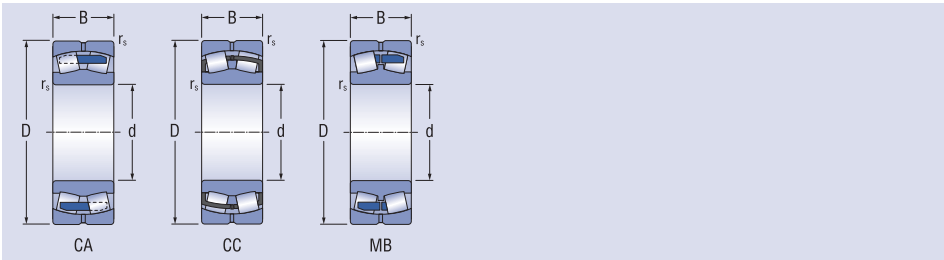

Dimensions				Bearing designation		Basic load rating		Fatigue load limit	Limiting speed		Mass	Corresponding			Coefficients			
d	D	B	rs min	cylindrical bore	tapered bore	dynamic	static	Cu	for lubrication with grease	oil	kg	Adapter sleeve	Withdrawal sleeve	Withdrawal nut	e	Y1	Y2	Y0
						Cr	Cor		min ⁻¹									
20	52	15	1.1	21304CA	21304CAK	33.7	32.1	3.91	9 000	11 000	0,18	H304	-	-	0.30	2.25	3.34	2.2
25	52	18	1.0	22205CA	22205CAK	43.2	45.0	5.48	8 000	10 000	0,18	H305	-	-	0.34	2	3	2
	52	18	1.0	22205CC	22205CCK	43.2	45.0	5.48	8 000	10 000	0,18	H305	-	-	0.34	2	3	2
	62	17	1.1	21305CA	21305CAK	48.0	49.3	6.01	7 000	8 000	0,28	H305	-	-	0.30	2.3	3.4	2.2
30	62	20	1.0	22206MB	22206MBK	53.0	56.8	6.92	5 300	8 000	0,29	H306	-	-	0.31	2.2	3.2	2.1
	62	20	1.0	22206CA	22206CAK	56.0	61.0	7.43	6 300	8 000	0,30	H306	-	-	0.31	2.2	3.2	2.1
	62	20	1.0	22206CC	22206CCK	56.0	61.0	7.43	6 700	8 500	0,28	H306	-	-	0.31	2.2	3.2	2.1
	72	19	1.1	21306CA	21306CAK	57.9	63.9	7.80	5 500	7 000	0,41	H306	-	-	0.27	2.5	3.7	2.5
35	72	23	1.1	22207MB	22207MBK	73.2	83.1	10.13	5 800	7 000	0,43	H307	-	-	0.31	2.2	3.3	2.2
	72	23	1.1	22207CA	22207CAK	75.0	83.1	10.13	6 300	7 700	0,45	H307	-	-	0.31	2.2	3.3	2.2
	72	23	1.1	22207CC	22207CCK	75.0	83.1	10.13	6 600	8 000	0,44	H307	-	-	0.31	2.2	3.3	2.2
	80	21	1.5	21307CA	21307CAK	67.0	76.0	9.26	5 000	6 300	0,54	H307	-	-	0.28	2.4	3.6	2.5
40	80	23	1.1	22208MB	22208MBK	78.5	91.9	11.20	5 500	6 600	0,55	H308	AH308	KM9	0.27	2.5	3.7	2.4
	80	23	1.1	22208CA	22208CAK	86.9	93.5	11.40	6 000	7 000	0,54	H308	AH308	KM9	0.27	2.5	3.7	2.4
	80	23	1.1	22208CC	22208CCK	86.9	93.5	11.40	6 000	7 300	0,52	H308	AH308	KM9	0.27	2.5	3.7	2.4
	90	23	1.5	21308CA	21308CAK	92.3	99.0	12.07	4 600	5 500	0,75	H308	AH308	KM9	0.26	2.6	3.9	2.6
	90	23	1.5	21308CC	21308CCK	92.3	99.0	12.07	4 600	5 500	0,74	H308	AH308	KM9	0.26	2.6	3.9	2.6
	90	33	1.5	22308MB	22308MBK	116	129	17.33	5 000	6 000	1,03	H2308	AH2308	KM9	0.36	1.8	2.6	1.8
	90	33	1.5	22308CA	22308CAK	124	142	17.33	5 300	6 300	1,00	H2308	AH2308	KM9	0.36	1.8	2.6	1.8
	90	33	1.5	22308CC	22308CCK	124	142	17.33	5 300	6 300	1,02	H2308	AH2308	KM9	0.36	1.8	2.6	1.8
45	85	23	1.1	22209MB	22209MBK	84.2	97.6	11.90	5 000	6 000	0,59	H309	AH309	KM10	0.25	2.7	4	2.6
	85	23	1.1	22209CA	22209CAK	93.0	102	12.44	5 500	7 000	0,58	H309	AH309	KM10	0.25	2.7	4	2.6
	85	23	1.1	22209CC	22209CCK	93.0	102	12.44	5 500	7 000	0,57	H309	AH309	KM10	0.25	2.7	4	2.6
	100	25	1.5	21309CA	21309CAK	115	121	14.70	3 200	4 000	1,02	H309	AH309	KM10	0.24	2.8	4.2	2.8
	100	25	1.5	21309CC	21309CCK	115	121	14.70	3 200	4 000	1,00	H309	AH309	KM10	0.24	2.8	4.2	2.8
	100	36	1.5	22309MB	22309MBK	143	169	20.54	5 000	6 000	1,40	H2309	AH2309	KM10	0.36	1.9	2.8	1.9
	100	36	1.5	22309CA	22309CAK	156	175	21.34	5 500	7 000	1,38	H2309	AH2309	KM10	0.36	1.9	2.8	1.9
	100	36	1.5	22309CC	22309CCK	156	175	21.34	5 500	7 000	1,37	H2309	AH2309	KM10	0.36	1.9	2.8	1.9
50	90	23	1.1	22210MB	22210MBK	86.8	104	12.62	3 800	4 800	0,67	H310	AHX310	KM11	0.24	2.8	4.2	2.8
	90	23	1.1	22210CA	22210CAK	95.0	112	13.65	4 600	5 400	0,62	H310	AHX310	KM11	0.24	2.8	4.2	2.8
	90	23	1.1	22210CC	22210CCK	95.0	112	13.65	4 600	5 400	0,61	H310	AHX310	KM11	0.24	2.8	4.2	2.8
	110	27	2.0	21310CA	21310CAK	129	144	17.56	2 800	3 800	1,30	H310	AHX310	KM11	0.24	2.8	4.2	2.8
	110	27	2.0	21310CC	21310CCK	129	144	17.56	2 800	3 800	1,30	H310	AHX310	KM11	0.24	2.8	4.2	2.8
	110	40	2.0	22310MB	22310MBK	193	227	27.70	3 400	4 300	1,90	H2310	AHX2310	KM11	0.36	1.9	2.7	1.8
	110	40	2.0	22310CA	22310CAK	193	227	27.70	4 600	5 600	1,85	H2310	AHX2310	KM11	0.36	1.9	2.7	1.8
	110	40	2.0	22310CC	22310CCK	193	227	27.70	4 600	5 600	1,79	H2310	AHX2310	KM11	0.36	1.9	2.7	1.8

Double - Row Spherical Roller Bearings

d = 55 - 75 mm

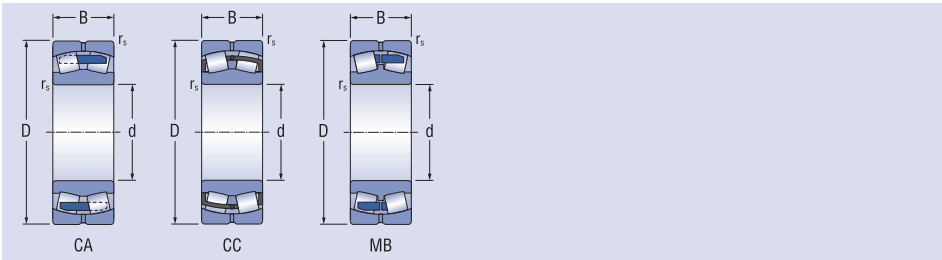

Dimensions				Bearing designation		Basic load rating		Fatigue load limit	Limiting speed		Mass	Corresponding			Coefficients			
				cylindrical bore	tapered bore	dynamic	static		for lubrication with grease	oil		Adapter sleeve	Withdrawal sleeve	Withdrawal nut	e	Y ₁	Y ₂	Y ₀
d	D	B	r _s min			C _r	C _{0r}	C _u			kg							
mm						kN			min ⁻¹									
55	100	25	1.5	22211MB	22211MBK	102	119	14.48	3 400	4 300	0.86	H311	AHX311	KM12	0.23	2.9	4.4	2.9
	100	25	1.5	22211CA	22211CAK	106	126	15.35	4 000	5 000	0.84	H311	AHX311	KM12	0.23	2.9	4.4	2.9
	100	25	1.5	22211CC	22211CCK	106	126	15.35	4 000	5 200	0.84	H311	AHX311	KM12	0.23	2.9	4.4	2.9
	120	29	2.0	21311CA	21311CAK	146	174	21.26	2 600	3 400	1.65	H311	AHX311	KM12	0.24	2.8	4.2	2.8
	120	29	2.0	21311CC	21311CCK	146	174	21.26	2 600	3 400	1.65	H311	AHX311	KM12	0.24	2.8	4.2	2.8
	120	43	2.0	22311MB	22311MBK	210	252	30.71	3 000	3 800	2.40	H2311	AHX2311	KM12	0.35	1.9	2.8	1.9
	120	43	2.0	22311CA	22311CAK	224	258	31.46	4 000	4 800	2.35	H2311	AHX2311	KM12	0.35	1.9	2.8	1.9
	120	43	2.0	22311CC	22311CCK	226	258	31.70	4 000	4 800	2.31	H2311	AHX2311	KM12	0.35	1.9	2.8	1.9
60	110	28	1.5	22212MB	22212MBK	129	146	17.78	3 200	4 000	1.22	H312	AHX312	KM13	0.24	2.8	4.2	2.8
	110	28	1.5	22212CA	22212CAK	140	166	20.24	3 600	4 500	1.20	H312	AHX312	KM13	0.24	2.8	4.2	2.8
	110	28	1.5	22212CC	22212CCK	140	166	20.24	3 600	4 500	1.15	H312	AHX312	KM13	0.24	2.8	4.2	2.8
	130	31	2.1	21312CA	21312CAK	167	203	24.75	2 400	3 200	2.08	H312	AHX312	KM13	0.22	3	4.6	2.8
	130	31	2.1	21312CC	21312CCK	167	203	24.75	2 400	3 200	2.08	H312	AHX312	KM13	0.22	3	4.6	2.8
	130	46	2.1	22312MB	22312MBK	244	296	36.04	2 800	3 600	3.00	H2312	AHX2312	KM13	0.35	1.9	2.9	1.9
	130	46	2.1	22312CA	22312CAK	255	296	36.04	3 800	4 400	2.95	H2312	AHX2312	KM13	0.35	1.9	2.9	1.9
	130	46	2.1	22312CC	22312CCK	255	301	36.73	3 800	4 400	2.88	H2312	AHX2312	KM13	0.35	1.9	2.9	1.9
65	120	31	1.5	22213MB	22213MBK	168	209	25.47	2 800	3 600	1.63	H313	AH313	KM15	0.24	2.9	4.2	2.8
	120	31	1.5	22213CA	22213CAK	168	209	25.47	3 600	4 800	1.60	H313	AH313	KM15	0.24	2.9	4.2	2.8
	120	31	1.5	22213CC	22213CCK	168	209	25.47	3 600	4 800	1.54	H313	AH313	KM15	0.24	2.9	4.2	2.8
	140	33	2.1	21313CA	21313CAK	183	239	28.66	2 200	3 000	2.57	H313	AH313	KM15	0.23	2.9	4.3	2.8
	140	33	2.1	21313CC	21313CCK	183	239	28.66	2 200	3 000	2.57	H313	AH313	KM15	0.23	2.9	4.3	2.8
	140	48	2.1	22313MB	22313MBK	295	353	42.38	2 400	3 200	3.60	H2313	AH2313	KM15	0.34	2	3	2
	140	48	2.1	22313CA	22313CAK	295	353	42.38	3 600	4 200	3.55	H2313	AH2313	KM15	0.34	2	3	2
	140	48	2.1	22313CC	22313CCK	295	353	42.38	3 600	4 200	3.47	H2313	AH2313	KM15	0.34	2	3	2
70	125	31	1.5	22214MB	22214MBK	176	219	26.68	2 600	3 400	1.66	H314	AH314	KM16	0.23	2.9	4.2	2.8
	125	31	1.5	22214CA	22214CAK	176	221	26.95	3 600	4 600	1.70	H314	AH314	KM16	0.23	2.9	4.2	2.8
	125	31	1.5	22214CC	22214CCK	176	221	26.95	3 600	4 600	1.60	H314	AH314	KM16	0.23	2.9	4.2	2.8
	150	35	2.1	21314CA	21314CAK	218	276	32.43	2 000	2 800	3.11	H314	AH314	KM16	0.23	2.9	4.3	2.9
	150	35	2.1	21314CC	21314CCK	218	276	32.43	2 000	2 800	3.11	H314	AH314	KM16	0.23	2.9	4.3	2.9
	150	51	2.1	22314MB	22314MBK	342	426	50.11	3 600	4 000	4.40	H2314	AHX2314	KM16	0.34	2	3	2
	150	51	2.1	22314CA	22314CAK	342	426	50.11	3 600	4 000	4.40	H2314	AHX2314	KM16	0.34	2	3	2
	150	51	2.1	22314CC	22314CCK	342	426	50.11	3 600	4 000	4.34	H2314	AHX2314	KM16	0.34	2	3	2
75	130	31	1.5	22215MB	22215MBK	185	236	28.50	2 400	3 200	1.75	H315	AH315	KM17	0.22	3.1	4.5	2.9
	130	31	1.5	22215CA	22215CAK	185	236	28.50	3 400	4 200	1.80	H315	AH315	KM17	0.22	3.1	4.5	2.9
	130	31	1.5	22215CC	22215CCK	185	236	28.50	3 400	4 200	1.69	H315	AH315	KM17	0.22	3.1	4.5	2.9
	160	37	2.1	21315CA	21315CAK	245	311	35.81	1 900	2 600	3.76	H315	AH315	KM17	0.23	2.9	4.4	2.9
	160	37	2.1	21315CC	21315CCK	245	311	35.81	1 900	2 600	3.76	H315	AH315	KM17	0.23	2.9	4.4	2.9
	160	55	2.1	22315MB	22315MBK	373	447	51.71	2 000	2 800	5.40	H2315	AHX2315	KM17	0.33	2	3	2
	160	55	2.1	22315CA	22315CAK	373	451	52.17	3 000	3 600	5.35	H2315	AHX2315	KM17	0.33	2	3	2
	160	55	2.1	22315CC	22315CCK	373	461	53.33	3 000	3 600	5.28	H2315	AHX2315	KM17	0.33	2	3	2

Double - Row Spherical Roller Bearings

d = 80 - 95 mm

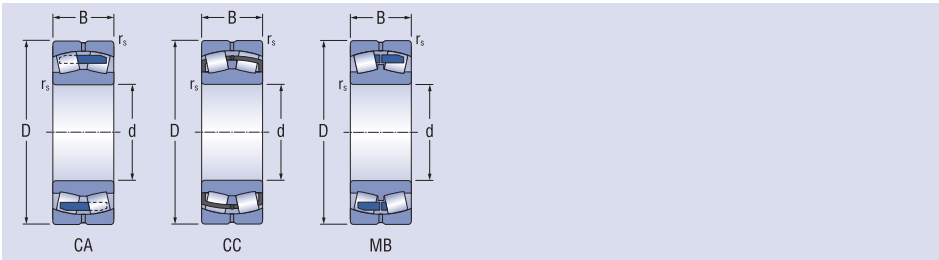

Dimensions	Bearing designation		Basic load rating	Fatigue load limit	Limiting speed	Mass	Corresponding			Coefficients								
	cylindrical bore	tapered bore					dynamic	static	grease	oil	Adapter sleeve	Withdrawal sleeve	Withdrawal nut	e	Y ₁	Y ₂	Y ₀	
d	D	B	r _s min	C _r	C _{0r}	C _u												
mm				kN			min ⁻¹	kg										
80	140	33	2.0	22216MB	22216MBK	199	257	30.29	3 200	3 800	2.14	H316	AH316	KM18	0.22	3.1	4.5	3
	140	33	2.0	22216CA	22216CAK	210	265	31.27	3 200	3 800	2.09	H316	AH316	KM18	0.22	3.1	4.5	3
	140	33	2.0	22216CC	22216CCK	210	265	31.27	3 200	3 800	2.14	H316	AH316	KM18	0.22	3.1	4.5	3
	170	39	2.1	21316CA	21316CAK	268	359	40.65	1 800	2 400	4.47	H316	AH316	KM18	0.23	3	4.4	2.9
	170	39	2.1	21316CC	21316CCK	268	359	40.65	1 800	2 400	4.53	H316	AH316	KM18	0.23	3	4.4	2.9
	170	58	2.1	22316MB	22316MBK	436	533	60.55	1 900	2 600	6.40	H2316	AHX2316	KM18	0.33	2	3	2
	170	58	2.1	22316CA	22316CAK	436	533	60.55	2 800	3 400	6.39	H2316	AHX2316	KM18	0.33	2	3	2
	170	58	2.1	22316CC	22316CCK	436	533	60.55	2 800	3 400	6.32	H2316	AHX2316	KM18	0.33	2	3	2
85	150	36	2.0	22217MB	22217MBK	237	310	35.91	2 000	2 800	2.70	H317	AHX317	KM19	0.22	3	4.4	2.9
	150	36	2.0	22217CA	22217CAK	256	330	38.17	3 000	3 800	2.67	H317	AHX317	KM19	0.22	3	4.4	2.9
	150	36	2.0	22217CC	22217CCK	256	330	38.17	3 000	3 800	2.73	H317	AHX317	KM19	0.22	3	4.4	2.9
	180	41	3.0	21317CA	21317CAK	313	397	44.30	1 700	2 200	4.98	H317	AHX317	KM19	0.24	2.8	4.2	2.8
	180	41	3.0	21317CC	21317CCK	313	397	44.30	1 700	2 200	5.15	H317	AHX317	KM19	0.24	2.8	4.2	2.8
	180	60	3.0	22317MB	22317MBK	432	560	62.52	1 800	2 400	7.40	H2317	AHX2317	KM19	0.32	2.1	3.1	2
	180	60	3.0	22317CA	22317CAK	433	560	62.52	2 500	3 200	7.35	H2317	AHX2317	KM19	0.32	2.1	3.1	2
	180	60	3.0	22317CC	22317CCK	433	572	63.86	2 500	3 200	7.27	H2317	AHX2317	KM19	0.32	2.1	3.1	2
90	160	40	2.0	22218MB	22218MBK	282	374	42.50	1 900	2 600	3.46	H318	AHX318	KM20	0.23	2.9	4.2	2.8
	160	40	2.0	22218CA	22218CAK	282	374	42.48	2 800	3 600	3.41	H318	AHX318	KM20	0.23	2.9	4.2	2.8
	160	40	2.0	22218CC	22218CCK	282	374	42.48	2 800	3 600	3.46	H318	AHX318	KM20	0.23	2.9	4.2	2.8
	160	52,4	2.0	23218CA	23218CAK	365	492	56.01	1 700	2 200	4.56	H2318	AHX3218	KM20	0.31	2.2	3.3	2.2
	160	52,4	2.0	23218CC	23218CCK	365	497	56.57	1 800	2 400	4.56	H2318	AHX3218	KM20	0.31	2.2	3.3	2.2
	190	43	3.0	21318CA	21318CAK	351	433	47.63	1 600	2 200	5.82	H318	AHX318	KM20	0.23	3	4.5	2.9
	190	43	3.0	21318CC	21318CCK	351	433	47.63	1 600	2 200	6.05	H318	AHX318	KM20	0.23	3	4.5	2.9
	190	64	3.0	22318MB	22318MBK	489	641	70.37	1 700	2 200	8.69	H2318	AHX2318	KM20	0.33	2.1	3.1	2
	190	64	3.0	22318CA	22318CAK	489	641	70.37	2 600	3 000	8.40	H2318	AHX2318	KM20	0.33	2.1	3.1	2
	190	64	3.0	22318CC	22318CCK	497	659	72.32	2 600	3 000	8.69	H2318	AHX2318	KM20	0.33	2.1	3.1	2
95	170	43	2.1	22219MB	22219MBK	315	411	45.85	1 800	2 400	4.20	H319	AHX319	KM21	0.23	2.9	4.2	2.7
	170	43	2.1	22219CA	22219CAK	315	411	45.85	2 600	3 000	4.14	H319	AHX319	KM21	0.23	2.9	4.2	2.7
	170	43	2.1	22219CC	22219CCK	315	411	45.85	2 600	3 000	4.20	H319	AHX319	KM21	0.23	2.9	4.2	2.7
	200	45	3.0	21319CA	21319CAK	389	500	54.13	1 700	2 200	6.90	H319	AHX319	KM21	0.22	3	4.5	3
	200	45	3.0	21319CC	21319CCK	389	500	54.13	1 700	2 200	7.00	H319	AHX319	KM21	0.22	3	4.5	3
	200	67	3.0	22319MB	22319MBK	536	710	76.66	1 600	2 000	10.10	H2319	AHX2319	KM21	0.33	2.1	3.1	2
	200	67	3.0	22319CA	22319CAK	536	710	76.66	2 200	2 800	10.10	H2319	AHX2319	KM21	0.33	2.1	3.1	2
	200	67	3.0	22319CC	22319CCK	546	726	78.44	2 200	2 800	10.10	H2319	AHX2319	KM21	0.33	2.1	3.1	2

Double - Row Spherical Roller Bearings

d = 100 - 110 mm

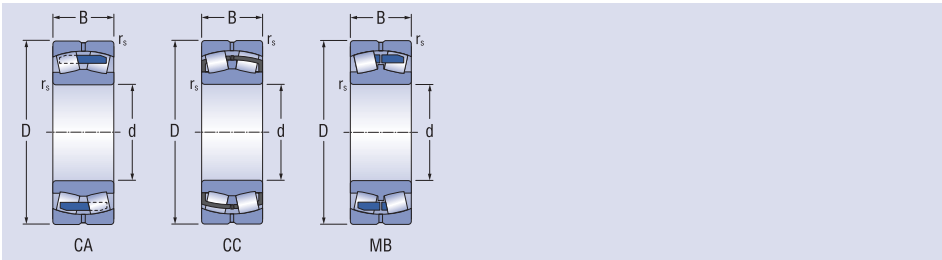

Dimensions	Bearing designation		Basic load rating	Fatigue load limit	Limiting speed	Mass	Corresponding			Coefficients								
	cylindrical bore	tapered bore					dynamic	static	grease	oil	Adapter sleeve	Withdrawal sleeve	Withdrawal nut	e	Y ₁	Y ₂	Y ₀	
d	D	B	r _s min	C _r	C _{0r}	C _u												
mm				kN			min ⁻¹	kg										
100	150	50	1.5	24020CA	24020CAK	251	448	51.03	1 200	1 500	3.02	-	AH24020	KM21	0.30	2.3	3.4	2.3
	150	50	1.5	24020CC	24020CCK	260	461	52.51	1 200	1 500	3.02	-	AH24020	KM21	0.30	2.3	3.4	2.3
	165	52	2.0	23120CA	23120CAK	360	540	60.37	1 600	2 000	4.43	H3120	AHX3120	KM22	0.29	2.4	3.5	2.3
	165	52	2.0	23120CC	23120CCK	362	545	60.93	1 700	2 200	4.43	H3120	AHX3120	KM22	0.29	2.4	3.5	2.3
	180	46	2.1	22220MB	22220MBK	361	474	52.13	1 700	2 200	5.03	H320	AHX320	KM22	0.24	2.9	4.1	2.7
	180	46	2.1	22220CA	22220CAK	361	474	52.11	2 500	3 200	4.96	H320	AHX320	KM22	0.24	2.9	4.1	2.7
	180	46	2.1	22220CC	22220CCK	361	474	52.11	2 500	3 200	5.15	H320	AHX320	KM22	0.24	2.9	4.1	2.7
	180	60,3	2.1	23220CA	23220CAK	428	637	73.12	1 600	2 000	6.73	H2320	AHX3220	KM22	0.31	2.2	3.2	2.1
	180	60,3	2.1	23220CC	23220CCK	433	649	74.51	1 600	2 200	6.73	H2320	AHX3220	KM22	0.31	2.2	3.2	2.1
	215	47	3.0	21320CA	21320CAK	433	546	57.97	1 600	2 000	8.28	H320	AHX320	KM22	0.22	3.1	4.6	3
	215	47	3.0	21320CC	21320CCK	433	546	57.97	1 600	2 000	8.41	H320	AHX320	KM22	0.22	3.1	4.6	3
	215	73	3.0	22320MB	22320MBK	626	840	89.01	1 800	2 200	13.03	H2320	AHX2320	KM22	0.33	2	3	2
	215	73	3.0	22320CA	22320CAK	626	840	89.01	2 200	2 600	12.95	H2320	AHX2320	KM22	0.33	2	3	2
	215	73	3.0	22320CC	22320CCK	637	857	90.78	2 200	2 600	13.03	H2320	AHX2320	KM22	0.33	2	3	2
110	170	45	2.0	23022MB	23022MBK	201	422	46.34	1 400	1 800	3.79	H322	AHX322	KM24	0.24	2.9	4.3	2.8
	170	45	2.0	23022CA	23022CAK	279	461	50.60	1 500	1 900	3.79	H322	AHX322	KM24	0.24	2.9	4.3	2.8
	170	45	2.0	23022CC	23022CCK	280	466	51.14	1 500	1 900	3.68	H322	AHX322	KM24	0.24	2.9	4.3	2.8
	180	56	2.0	23122MB	23122MBK	270	489	53.17	1 300	1 700	6.25	H3122	AHX3122	KM24	0.30	2.3	3.4	2.2
	180	56	2.0	23122CA	23122CAK	386	613	66.65	1 300	1 700	6.25	H3122	AHX3122	KM24	0.30	2.3	3.4	2.2
	180	56	2.0	23122CC	23122CCK	389	620	67.41	1 600	2 000	5.81	H3122	AHX3122	KM24	0.30	2.3	3.4	2.2
	180	69	2.0	24122CA	24122CAK	474	798	86.87	1 600	2 000	6.93	-	AH24122	KM23	0.35	1.9	2.8	1.9
	180	69	2.0	24122CC	24122CCK	474	798	86.87	1 600	2 000	6.90	-	AH24122	KM23	0.35	1.9	2.8	1.9
	200	53	2.1	22222MB	22222MBK	447	593	63.13	1 800	2 200	7.40	H322	AHX3122	KM24	0.25	2.7	4	2.6
	200	53	2.1	22222CA	22222CAK	447	593	63.13	2 200	3 000	7.23	H322	AHX3122	KM24	0.25	2.7	4	2.6
	200	53	2.1	22222CC	22222CCK	452	606	64.57	2 200	3 000	7.40	H322	AHX3122	KM24	0.25	2.7	4	2.6
	200	69,8	2.1	23222CA	23222CAK	530	809	86.30	1 400	1 800	9.70	H2322	AHX3222	KM25	0.33	2.1	3.1	2
	200	69,8	2.1	23222CC	23222CCK	536	824	87.91	1 500	1 900	9.70	H2322	AHX3222	KM25	0.33	2.1	3.1	2
	240	50	3.0	21322CA	21322CAK	490	671	68.63	1 400	1 800	11.64	H322	AHX322	KM25	0.22	3.1	4.6	3
	240	50	3.0	21322CC	21322CCK	490	671	68.63	1 400	1 800	11.64	H322	AHX322	KM25	0.22	3.1	4.6	3
	240	80	3.0	22322MB	22322MBK	750	960	98.65	1 200	1 600	18.22	H2322	AHX2322	KM25	0.33	2.1	3.1	2
	240	80	3.0	22322CA	22322CAK	786	993	102.1	1 800	2 200	18.22	H2322	AHX2322	KM25	0.33	2.1	3.1	2
	240	80	3.0	22322CC	22322CCK	786	993	102.1	1 800	2 200	17.80	H2322	AHX2322	KM25	0.33	2.1	3.1	2

Double - Row Spherical Roller Bearings

d = 120 - 130 mm

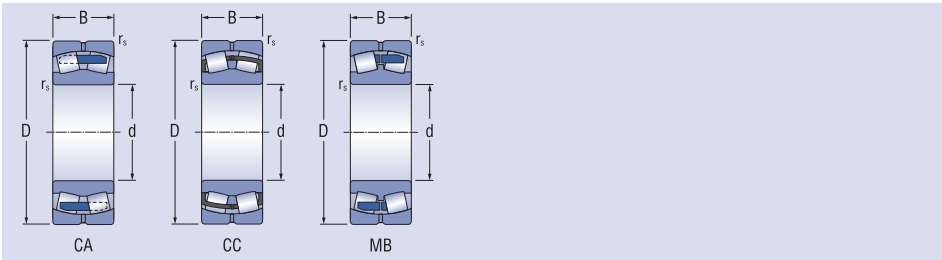

Dimensions	Bearing designation		Basic load rating	Fatigue load limit	Limiting speed	Mass	Corresponding			Coefficients								
	cylindrical bore	tapered bore					dynamic	static	grease	oil	Adapter sleeve	Withdrawal sleeve	Withdrawal nut	e	Y ₁	Y ₂	Y ₀	
d	D	B	r _s min	C _r	C _{0r}	C _u												
mm				kN			min ⁻¹	kg										
120	180	46	2.0	23024MB	23024MBK	218	484	52.16	1 200	1 600	3.86	H3024	AHX3024	KM26	0.23	3	4.5	2.9
	180	46	2.0	23024CA	23024CAK	354	560	60.36	1 400	1 800	3.86	H3024	AHX3024	KM26	0.23	3	4.5	2.9
	180	46	2.0	23024CC	23024CCK	359	565	60.90	1 400	1 800	3.81	H3024	AHX3024	KM26	0.23	3	4.5	2.9
	180	60	2.0	24024CA	24024CAK	390	700	75.43	1 500	2 000	5.29	-	AH24024	KM25	0.30	2.3	3.4	2.2
	180	60	2.0	24024CC	24024CCK	391	700	75.43	1 500	2 000	5.29	-	AH24024	KM25	0.30	2.3	3.4	2.2
	200	62	2.0	23124MB	23124MBK	321	589	62.08	1 100	1 500	7.85	H3124	AHX3124	KM26	0.28	2.4	3.5	2.3
	200	62	2.0	23124CA	23124CAK	531	780	82.21	1 300	1 700	7.85	H3124	AHX3124	KM26	0.28	2.4	3.5	2.3
	200	62	2.0	23124CC	23124CCK	530	780	82.21	1 400	1 800	7.85	H3124	AHX3124	KM26	0.28	2.4	3.5	2.3
	200	80	2.0	24124CA	24124CAK	645	1 028	108.6	1 400	1 800	10.18	-	AH24124	KM26	0.37	1.8	2.7	1.8
	200	80	2.0	24124CC	24124CCK	645	1 028	108.6	1 400	1 800	10.18	-	AH24124	KM26	0.37	1.8	2.7	1.8
	215	58	2.1	22224MB	22224MBK	520	730	76.02	1 100	1 500	9.17	H3124	AHX3124	KM26	0.25	2.7	3.9	2.5
	215	58	2.1	22224CA	22224CAK	520	730	76.02	1 300	1 700	9.14	H3124	AHX3124	KM26	0.25	2.7	3.9	2.5
	215	58	2.1	22224CC	22224CCK	520	730	76.02	1 400	1 800	9.17	H3124	AHX3124	KM26	0.25	2.7	3.9	2.5
	215	76	2.1	23224CA	23224CAK	660	968	101.1	1 300	1 700	12.02	H2324	AHX3224	KM27	0.33	2	3	2
	215	76	2.1	23224CC	23224CCK	668	984	102.7	1 300	1 700	12.02	H2324	AHX3224	KM27	0.33	2	3	2
	260	86	3.0	22324MB	22324MBK	895	1 145	114.8	1 100	1 500	22.26	H2324	AHX2324	KM27	0.33	2.1	3.1	2
	260	86	3.0	22324CA	22324CAK	895	1 145	114.8	1 700	2 000	22.26	H2324	AHX2324	KM27	0.33	2.1	3.1	2
	260	86	3.0	22324CC	22324CCK	895	1 145	114.8	1 700	2 000	22.26	H2324	AHX2324	KM27	0.33	2.1	3.1	2
130	200	52	2.0	23026MB	23026MBK	278	626	65.51	1 100	1 500	6.08	H3026	AHX3026	KM28	0.23	2.9	4.3	2.9
	200	52	2.0	23026CA	23026CAK	400	666	69.70	1 200	1 600	6.08	H3026	AHX3026	KM28	0.23	2.9	4.3	2.9
	200	52	2.0	23026CC	23026CCK	400	666	69.70	1 200	1 600	6.05	H3026	AHX3026	KM28	0.23	2.9	4.3	2.9
	200	69	2.0	24026CA	24026CAK	472	852	89.25	1 400	1 800	7.95	-	AH24026	KM27	0.31	2.2	3.2	2.1
	200	69	2.0	24026CC	24026CCK	486	878	91.97	1 400	1 800	7.95	-	AH24026	KM27	0.31	2.2	3.2	2.1
	210	64	2.0	23126CA	23126CAK	492	812	84.31	1 300	1 700	8.54	H3126	AHX3126	KM28	0.28	2.4	3.6	2.4
	210	64	2.0	23126CC	23126CCK	496	826	85.76	1 300	1 700	8.54	H3126	AHX3126	KM28	0.28	2.4	3.6	2.4
	210	80	2.0	24126CA	24126CAK	585	1 030	106.8	1 200	1 600	10.83	-	AH24126	KM28	0.35	1.9	2.9	1.9
	210	80	2.0	24126CC	24126CCK	616	1 036	107.5	1 300	1 700	10.83	-	AH24126	KM28	0.35	1.9	2.9	1.9
	230	64	3.0	22226MB	22226MBK	625	883	94.12	1 200	1 600	11.46	H3126	AHX3126	KM28	0.26	2.6	3.8	2.5
	230	64	3.0	22226CA	22226CAK	625	883	94.12	2 000	2 600	11.32	H3126	AHX3126	KM28	0.26	2.6	3.8	2.5
	230	64	3.0	22226CC	22226CCK	625	883	94.12	2 000	2 600	11.43	H3126	AHX3126	KM28	0.26	2.6	3.8	2.5
	230	80	3.0	23226CA	23226CAK	759	1 172	119.5	1 200	1 600	14.36	H2326	AHX3226	KM29	0.33	2.1	3.1	2
	230	80	3.0	23226CC	23226CCK	759	1 172	119.5	1 200	1 600	14.36	H2326	AHX3226	KM29	0.33	2.1	3.1	2
	280	93	4.0	22326MB	22326MBK	1 020	1 377	134.5	950	1 300	27.71	H2326	AHX2326	KM29	0.33	2.1	3.1	2
	280	93	4.0	22326CA	22326CAK	1 020	1 377	134.5	1 600	1 900	27.71	H2326	AHX2326	KM29	0.33	2.1	3.1	2
	280	93	4.0	22326CC	22326CCK	1 020	1 380	134.8	1 600	1 900	27.46	H2326	AHX2326	KM29	0.33	2.1	3.1	2

Double - Row Spherical Roller Bearings

d = 140 - 150 mm

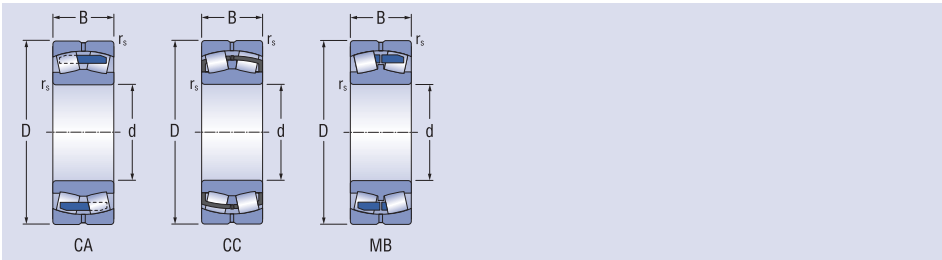

Dimensions	Bearing designation			Basic load rating	Fatigue load limit	Limiting speed	Mass	Corresponding			Coefficients							
	cylindrical bore	tapered bore						dynamic	static	for lubrication with grease	oil	Adapter sleeve	Withdrawal sleeve	Withdrawal nut	e	Y ₁	Y ₂	Y ₀
d	D	B	r _s min	C _r	C _{0r}	C _u												
mm				kN			min ⁻¹	kg										
140	210	53	2.0	23028MB	23028MBK	294	654	67.31	950	1 300	6.52	H3028	AHX3028	KM30	0.22	3	4.5	3
	210	53	2.0	23028CA	23028CAK	444	719	74.00	1 100	1 500	6.52	H3028	AHX3028	KM30	0.22	3	4.5	3
	210	53	2.0	23028CC	23028CCK	450	760	78.22	1 600	1 900	6.52	H3028	AHX3028	KM30	0.22	3	4.5	3
	210	69	2.0	24028CA	24028CAK	505	901	92.79	1 200	1 600	8.52	-	AH24028	KM29	0.29	2.3	3.4	2.3
	210	69	2.0	24028CC	24028CCK	505	922	94.95	1 300	1 700	8.52	-	AH24028	KM29	0.29	2.3	3.4	2.3
	225	68	2.1	23128MB	23128MBK	410	623	63.02	950	1 300	10.28	H3128	AHX3128	KM30	0.27	2.5	3.7	2.4
	225	68	2.1	23128CA	23128CAK	561	953	96.40	1 100	1 500	10.28	H3128	AHX3128	KM30	0.27	2.5	3.7	2.4
	225	68	2.1	23128CC	23128CCK	554	932	94.27	1 200	1 600	10.28	H3128	AHX3128	KM30	0.27	2.5	3.7	2.4
	225	85	2.1	24128CA	24128CAK	680	1 200	121.8	1 100	1 500	13.13	-	AH24128	KM30	0.35	1.9	2.9	1.9
	225	85	2.1	24128CC	24128CCK	690	1 236	125.5	1 200	1 600	13.13	-	AH24128	KM30	0.35	1.9	2.9	1.9
	250	68	3.0	22228MB	22228MBK	720	990	98.51	1 000	1 400	14.48	H3128	AHX3128	KM30	0.25	2.7	3.9	2.5
	250	68	3.0	22228CA	22228CAK	720	990	98.51	1 700	2 200	14.48	H3128	AHX3128	KM30	0.25	2.7	3.9	2.5
	250	68	3.0	22228CC	22228CCK	720	990	98.51	1 800	2 200	14.48	H3128	AHX3128	KM30	0.25	2.7	3.9	2.5
	250	88	3.0	23228CA	23228CAK	826	1 320	131.5	1 000	1 400	19.28	H2328	AHX3228	KM31	0.33	2	3	2
	250	88	3.0	23228CC	23228CCK	836	1 340	133.5	1 100	1 500	19.28	H2328	AHX3228	KM31	0.33	2	3	2
	300	102	4.0	22328MB	22328MBK	1 154	1 620	154.9	900	1 200	35.50	H2328	AHX2328	KM31	0.34	2	3	2
300	102	4.0	22328CA	22328CAK	1 154	1 620	154.9	1 400	1 500	35.50	H2328	AHX2328	KM31	0.34	2	3	2	
300	102	4.0	22328CC	22328CCK	1 164	1 680	160.6	1 400	1 500	35.16	H2328	AHX2328	KM31	0.34	2	3	2	
150	225	56	2.1	23030MB	23030MBK	338	790	79.63	900	1 200	7.77	H3030	AHX3030	KM32	0.22	3.1	4.6	3
	225	56	2.1	23030CA	23030CAK	461	804	81.04	1 100	1 400	7.77	H3030	AHX3030	KM32	0.22	3.1	4.6	3
	225	56	2.1	23030CC	23030CCK	461	804	81.04	1 100	1 400	7.77	H3030	AHX3030	KM32	0.22	3.1	4.6	3
	225	75	2.1	24030CA	24030CAK	570	1 070	107.8	1 100	1 400	10.60	-	AH24030	KM31	0.30	2.3	3.4	2.2
	225	75	2.1	24030CC	24030CCK	587	1 100	110.9	1 200	1 500	10.60	-	AH24030	KM31	0.30	2.3	3.4	2.2
	250	80	2.1	23130MB	23130MBK	527	1 110	109.5	850	1 100	16.08	H3130	AHX3130	KM33	0.29	2.3	3.4	2.3
	250	80	2.1	23130CA	23130CAK	761	1 263	124.6	1 000	1 300	16.08	H3130	AHX3130	KM33	0.29	2.3	3.4	2.3
	250	80	2.1	23130CC	23130CCK	761	1 263	124.6	1 100	1 400	16.08	H3130	AHX3130	KM33	0.29	2.3	3.4	2.3
	250	100	2.1	24130CA	24130CAK	906	1 600	157.8	1 000	1 300	19.80	-	AH24130	KM32	0.37	1.8	2.7	1.8
	250	100	2.1	24130CC	24130CCK	910	1 650	162.8	1 100	1 400	19.80	-	AH24130	KM32	0.37	1.8	2.7	1.8
	270	73	3.0	22230MB	22230MBK	523	900	87.80	1 200	1 700	18.77	H3130	AHX3130	KM33	0.25	2.7	3.9	2.5
	270	73	3.0	22230CA	22230CAK	970	1 330	129.7	1 800	2 000	18.77	H3130	AHX3130	KM33	0.25	2.7	3.9	2.5
	270	73	3.0	22230CC	22230CCK	970	1 330	129.7	1 800	2 000	18.34	H3130	AHX3130	KM33	0.25	2.7	3.9	2.5
	270	96	3.0	23230CA	23230CAK	1 008	1 560	152.2	950	1 300	24.50	H2330	AHX3230	KM33	0.33	2	3	2
	270	96	3.0	23230CC	23230CCK	1 008	1 586	154.7	1 100	1 400	24.50	H2330	AHX3230	KM33	0.33	2	3	2
	320	108	4.0	22330MB	22330MBK	1 300	1 790	168.5	850	1 100	43.13	H2330	AHX2330	KM33	0.33	2	3	2
	320	108	4.0	22330CA	22330CAK	1 300	1 850	174.3	1 200	1 500	43.13	H2330	AHX2330	KM33	0.33	2	3	2
	320	108	4.0	22330CC	22330CCK	1 308	1 905	179.5	1 200	1 500	42.82	H2330	AHX2330	KM33	0.33	2	3	2

Double - Row Spherical Roller Bearings

d = 160 - 170 mm

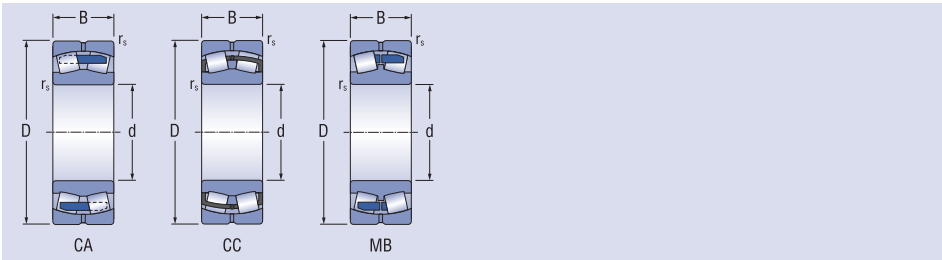

Dimensions	Bearing designation			Basic load rating	Fatigue	Limiting speed	Mass	Corresponding			Coefficients							
	cylindrical bore	tapered bore						dynamic	static	load limit	Adapter sleeve	Withdrawal sleeve	Withdrawal nut	e	Y ₁	Y ₂	Y ₀	
d	D	B	r _s min	C _r	C _{0r}	C _u												
mm				kN			min ⁻¹	kg										
160	240	60	2.1	23032MB	23032MBK	379	850	83.96	850	1 100	9.71	H3032	AH3032	KM34	0.22	3.1	4.6	3
	240	60	2.1	23032CA	23032CAK	529	930	91.86	1 000	1 300	9.54	H3032	AH3032	KM34	0.22	3.1	4.6	3
	240	60	2.1	23032CC	23032CCK	529	930	91.86	1 300	1 700	9.71	H3032	AH3032	KM34	0.22	3.1	4.6	3
	240	80	2.1	24032CA	24032CAK	710	1 330	131.5	1 000	1 300	12.98	-	AH24032	KM34	0.30	2.3	3.4	2.2
	240	80	2.1	24032CC	24032CCK	710	1 330	131.5	1 100	1 400	12.98	-	AH24032	KM34	0.30	2.3	3.4	2.2
	270	86	2.1	23132MB	23132MBK	536	1 140	110.0	800	1 000	20.51	H3132	AH3132	KM36	0.32	2.1	3	2
	270	86	2.1	23132CA	23132CAK	870	1 460	140.9	900	1 200	20.51	H3132	AH3132	KM36	0.32	2.1	3	2
	270	86	2.1	23132CC	23132CCK	870	1 480	142.8	1 000	1 300	20.51	H3132	AH3132	KM36	0.32	2.1	3	2
	270	109	2.1	24132CA	24132CAK	1 080	1 886	182.1	900	1 200	25.86	-	AH24132	KM34	0.38	1.8	2.7	1.8
	270	109	2.1	24132CC	24132CCK	1 080	1 930	186.3	1 000	1 300	25.86	-	AH24132	KM34	0.38	1.8	2.7	1.8
	290	80	3.0	22232MB	22232MBK	921	1 290	123.2	1 500	1 700	22.96	H3132	AH3132	KM36	0.26	2.6	3.8	2.5
	290	80	3.0	22232CA	22232CAK	921	1 290	123.2	1 700	1 900	22.96	H3132	AH3132	KM36	0.26	2.6	3.8	2.5
	290	80	3.0	22232CC	22232CCK	921	1 290	123.2	1 200	1 900	22.96	H3132	AH3132	KM36	0.26	2.6	3.8	2.5
	290	104	3.0	23232CA	23232CAK	1 129	1 837	175.1	1 700	1 900	30.20	H2332	AH3232	KM36	0.34	2	2.9	1.9
	290	104	3.0	23232CC	23232CCK	1 129	1 837	175.1	1 200	1 900	30.20	H2332	AH3232	KM36	0.34	2	2.9	1.9
	340	114	4.0	22332CA	22332CAK	1 470	1 950	180.6	1 100	1 300	51.50	H2332	AH2332	KM36	0.33	2	3	2
170	260	67	2.1	23034MB	23034MBK	458	1040	100.5	800	1 000	13.18	H3034	AH3034	KM36	0.23	2.9	4.4	2.9
	260	67	2.1	23034CA	23034CAK	726	1172	113.3	900	1 200	13.18	H3034	AH3034	KM36	0.23	2.9	4.4	2.9
	260	67	2.1	23034CC	23034CCK	733	1173	113.3	1 200	1 600	13.18	H3034	AH3034	KM36	0.23	2.9	4.4	2.9
	260	90	2.1	24034CA	24034CAK	841	1552	150.3	900	1 200	16.70	-	AH24034	KM36	0.31	2.2	3.2	2.1
	260	90	2.1	24034CC	24034CCK	841	1565	151.6	1 000	1 300	16.70	-	AH24034	KM36	0.31	2.2	3.2	2.1
	280	88	2.1	23134CA	23134CAK	960	1565	149.3	850	1 100	21.10	H3134	AH3134	KM38	0.29	2.4	3.5	2.3
	280	88	2.1	23134CC	23134CCK	960	1590	151.7	1 000	1 300	21.10	H3134	AH3134	KM38	0.29	2.4	3.5	2.3
	280	109	2.1	24134CA	24134CAK	1 110	1940	184.9	900	1 200	26.97	-	AH24134	KM36	0.36	1.9	2.8	1.8
	280	109	2.1	24134CC	24134CCK	1 110	1980	188.7	1 000	1 300	26.97	-	AH24134	KM36	0.36	1.9	2.8	1.8
	310	86	4.0	22234MB	22234MBK	740	1330	124.4	1 100	1 300	28.69	H3134	AH3134	KM38	0.26	2.6	3.9	2.6
	310	86	4.0	22234CA	22234CAK	990	1500	140.3	1 300	1 600	28.54	H3134	AH3134	KM38	0.26	2.6	3.9	2.6
	310	86	4.0	22234CC	22234CCK	1 002	1540	144.1	1 100	1 400	28.69	H3134	AH3134	KM38	0.26	2.6	3.9	2.6
	310	110	4.0	23234CA	23234CAK	1 244	2034	190.2	800	1 100	37.30	H2334	AH3234	KM38	0.34	2	3	2
	310	110	4.0	23234CC	23234CCK	1 244	2090	195.5	900	1 200	37.30	H2334	AH3234	KM38	0.34	2	3	2
	360	120	4.0	22334CA	22334CAK	1 560	2120	193.0	1 100	1 200	60.38	H2334	AH2334	KM38	0.34	2	3	2

Double - Row Spherical Roller Bearings

d = 180 - 200 mm

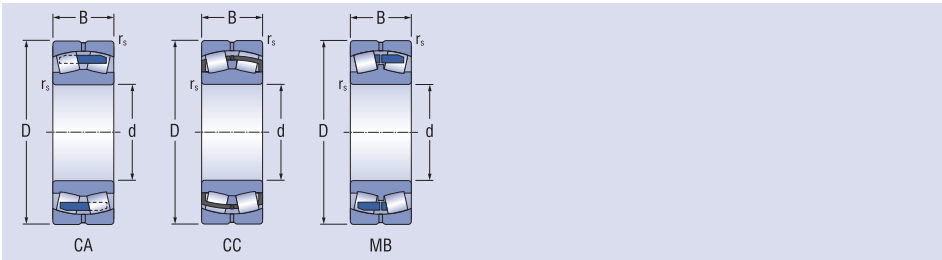

Dimensions	Bearing designation		Basic load rating	Fatigue load limit	Limiting speed	Mass	Corresponding			Coefficients									
	cylindrical bore	tapered bore					dynamic	static	for lubrication with grease	oil	Adapter sleeve	Withdrawal sleeve	Withdrawal nut	e	Y ₁	Y ₂	Y ₀		
d	D	B	r _s min	C _r	C _{0r}	C _u													
mm				kN			min ⁻¹	kg											
180	280	74	2.1	23036MB	23036MBK	556	1 260	119.2	750	950	17.62	H3036	AH3036	KM38	0.24	2.9	4.2	2.8	
	280	74	2.1	23036CA	23036CAK	830	1 350	127.7	900	1 100	17.62	H3036	AH3036	KM38	0.24	2.9	4.2	2.8	
	280	74	2.1	23036CC	23036CCK	840	1 350	127.7	1 200	1 400	16.95	H3036	AH3036	KM38	0.24	2.9	4.2	2.8	
	280	100	2.1	24036CA	24036CAK	979	1 830	173.4	900	1 100	23.35	-	AH24036	KM38	0.32	2.1	3.1	2	
	280	100	2.1	24036CC	24036CCK	979	1 870	177.2	1 000	1 300	23.35	-	AH24036	KM38	0.32	2.1	3.1	2	
	300	96	3.0	23136MB	23136MBK	1 060	1 850	173.2	750	900	27.12	H3136	AH3136	KM40	0.29	2.3	3.4	2.3	
	300	96	3.0	23136CA	23136CAK	1 140	1 860	174.1	800	1 000	27.12	H3136	AH3136	KM40	0.29	2.3	3.4	2.3	
	300	96	3.0	23136CC	23136CCK	1 140	1 880	176.0	900	1 200	26.97	H3136	AH3136	KM40	0.29	2.3	3.4	2.3	
	300	118	3.0	24136CA	24136CAK	1 270	2 230	208.5	800	1 000	34.02	-	AH24136	KM38	0.37	1.8	2.7	1.8	
	300	118	3.0	24136CC	24136CCK	1 270	2 280	213.2	900	1 200	34.02	-	AH24136	KM38	0.37	1.8	2.7	1.8	
	320	86	4.0	22236MB	22236MBK	1 080	1 410	130.3	900	1 100	29.82	H3136	AH2236	KM40	0.25	2.7	4	2.7	
	320	86	4.0	22236CA	22236CAK	1 080	1 590	146.9	1 300	1 500	29.71	H3136	AH2236	KM40	0.25	2.7	4	2.7	
	320	86	4.0	22236CC	22236CCK	1 080	1 630	150.6	1 100	1 300	29.45	H3136	AH2236	KM40	0.25	2.7	4	2.7	
	320	112	4.0	23236CA	23236CAK	1 280	2 170	200.7	1 000	1 200	39.32	H2336	AH3236	KM40	0.33	2.1	3.1	2	
	320	112	4.0	23236CC	23236CCK	1 310	2 230	206.2	1 100	1 300	39.32	H2336	AH3236	KM40	0.33	2.1	3.1	2	
	380	126	4.0	22336CA	22336CAK	1 762	2 636	234.3	1 000	1 100	69.26	H2336	AH2336	KM40	0.33	2.1	3.1	2	
	190	290	75	2.1	23038MB	23038MBK	570	1 260	117.8	700	900	20.03	H3038	AH3038	HML41T	0.23	2.9	4.4	2.9
		290	75	2.1	23038CA	23038CAK	867	1 490	139.4	1 000	1 200	20.03	H3038	AH3038	HML41T	0.23	2.9	4.4	2.9
290		75	2.1	23038CC	23038CCK	877	1 520	142.2	1 100	1 400	17.71	H3038	AH3038	HML41T	0.23	2.9	4.4	2.9	
290		100	2.1	24038CA	24038CAK	1 023	1 983	185.8	800	1 100	24.24	-	AH24038	KM40	0.31	2.2	3.2	2.1	
290		100	2.1	24038CC	24038CCK	1 023	1 983	185.8	900	1 200	24.24	-	AH24038	KM40	0.31	2.2	3.2	2.1	
320		104	3.0	23138MB	23138MBK	811	1 880	172.8	670	850	35.31	H3138	AH3138	HM42T	0.30	2.3	3.4	2.2	
320		104	3.0	23138CA	23138CAK	1 226	2 120	194.8	750	1 000	35.31	H3138	AH3138	HM42T	0.30	2.3	3.4	2.2	
320		104	3.0	23138CC	23138CCK	1 230	2 180	200.3	850	1 100	34.54	H3138	AH3138	HM42T	0.30	2.3	3.4	2.2	
320		128	3.0	24138CA	24138CAK	1 467	2 593	238.6	700	1 000	42.50	-	AH24138	KM40	0.40	1.7	2.5	1.7	
320		128	3.0	24138CC	24138CCK	1 467	2 660	244.7	850	1 100	42.50	-	AH24138	KM40	0.40	1.7	2.5	1.7	
340		92	4.0	22238CA	22238CAK	1 190	1 760	160.0	1 200	1 500	37.09	H3138	AH2238	HM42T	0.25	2.7	4	2.6	
340		120	4.0	23238CA	23238CAK	1 508	2 560	232.6	700	1 000	47.51	H2338	AH3238	HM42T	0.33	2	3	2	
340		120	4.0	23238CC	23238CCK	1 508	2 560	232.6	800	1 100	47.51	H2338	AH3238	HM42T	0.33	2	3	2	
400		132	5.0	22338CA	22338CAK	1 937	2 848	250.1	900	1 000	80.87	H2338	AH2338	HM42T	0.32	2.1	3.1	2	
200		310	82	2.1	23040MB	23040MBK	597	1 340	122.5	670	850	23.46	H3040	AH3040	HML43T	0.24	2.9	4.3	2.8
		310	82	2.1	23040CA	23040CAK	930	1 650	150.9	900	1 100	23.46	H3040	AH3040	HML43T	0.24	2.9	4.3	2.8
		310	82	2.1	23040CC	23040CCK	930	1 690	154.6	1 000	1 300	22.78	H3040	AH3040	HML43T	0.24	2.9	4.3	2.8
		310	109	2.1	24040CA	24040CAK	1 120	2 220	203.8	670	850	30.72	-	AH24040	HM42T	0.32	2.1	3.1	2.1
	310	109	2.1	24040CC	24040CCK	1 150	2 280	209.3	850	1 100	30.72	-	AH24040	HM42T	0.32	2.1	3.1	2.1	
	340	112	3.0	23140MB	23140MBK	937	2 070	186.8	630	800	42.99	H3140	AH3140	HM44T	0.30	2.2	3.3	2.2	
	340	112	3.0	23140CC	23140CCK	1 420	2 547	229.8	800	1 000	42.99	H3140	AH3140	HM44T	0.30	2.2	3.3	2.2	
	340	140	3.0	24140MB	24140MBK	1 480	2 550	230.1	700	900	53.15	-	AH24140	HM42T	0.39	1.9	2.6	1.7	
	340	140	3.0	24140CC	24140CCK	1 670	3 030	373.4	800	1 000	53.15	-	AH24140	HM42T	0.39	1.9	2.6	1.7	
	360	98	4.0	22240CA	22240CAK	1 290	1 990	177.7	1 100	1 400	43.95	H3140	AH2240	HM44T	0.25	2.6	3.9	2.6	
	360	128	4.0	23240CC	23240CCK	1 690	2 870	255.7	1 100	1 400	57.32	H2340	AH3240	HM44T	0.33	2	3	2	
	420	138	5.0	22340CA	22340CAK	2 117	3 126	270.5	730	900	92.78	H2340	AH2340	HM44T	0.32	2.1	3.1	2	

Double - Row Spherical Roller Bearings

d = 220 - 260 mm

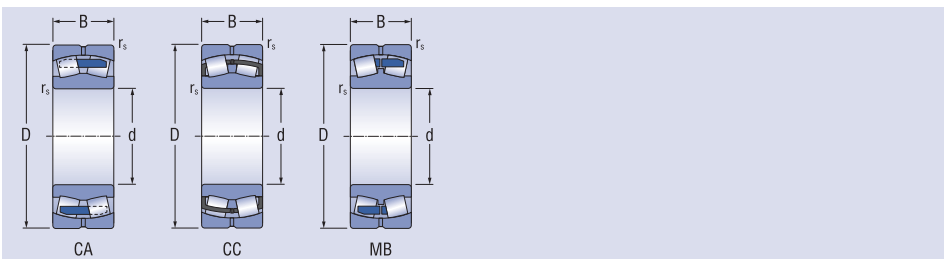

Dimensions	Bearing designation			Basic load rating	Fatigue	Limiting speed	Mass	Corresponding			Coefficients								
	cylindrical bore	tapered bore						dynamic	static	load limit	Adapter sleeve	Withdrawal sleeve	Withdrawal nut	e	Y ₁	Y ₂	Y ₀		
d	D	B	r _s min	C _r	C _{0r}	C _u													
mm	mm	mm	mm	kN	kN	kN	min ⁻¹	kg											
220	340	90	3.0	23044MB	23044MBK	783	1 860	165.6	600	750	28.8	H3944	AH3044	HML47T	0.22	3.0	4.5	2.9	
	340	90	3.0	23044CA	23044CAK	1 090	2 040	181.6	950	1 200	29.7	H3944	AH3044	HML47T	0.24	2.9	4.2	2.8	
	340	90	3.0	23044CC	23044CCK	1 090	2 040	181.6	950	1 200	29.7	H3944	AH3044	HML47T	0.24	2.9	4.2	2.8	
	340	118	3.0	24044CA	24044CAK	1 350	2 760	245.7	750	1 000	38.1	-	AOH24044	HM46T	0.32	2.1	3.1	2.1	
	340	118	3.0	24044CC	24044CCK	1 350	2 760	245.7	750	1 000	38.1	-	AOH24044	HM46T	0.32	2.1	3.1	2.1	
	370	120	4.0	23144MB	23144MBK	1 060	2 420	212.1	600	750	55.0	H3144	AH3144	HM48T	0.29	2.3	3.4	2.2	
	370	120	4.0	23144CC	23144CCK	1 660	2 900	254.1	700	950	51.5	H3144	AH3144	HM48T	0.29	2.3	3.4	2.2	
	370	120	4.0	23144CA	23144CAK	1 660	2 900	254.1	700	950	51.5	H3144	AH3144	HM48T	0.29	2.3	3.4	2.2	
	370	150	4.0	24144CC	24144CCK	1 900	3 580	313.7	700	950	62.3	-	AOH24144	HM46T	0.38	1.8	2.6	1.7	
	400	108	4.0	22244CA	22244CAK	1 500	2 380	205.7	730	900	61.5	H3144	AH2244	HM48T	0.25	2.7	4.0	2.6	
	400	144	4.0	23244CC	23244CCK	2 130	3 720	321.2	670	900	78.5	H2344	AH2344	HM48T	0.34	2.0	3.0	2.0	
	400	144	4.0	23244CA	23244CAK	2 130	3 720	321.2	670	900	78.5	H2344	AH2344	HM48T	0.34	2.0	3.0	2.0	
	460	145	5.0	22344CA	22344CAK	2 140	3 290	276.3	660	800	120.0	H2344	AH2344	HM48T	0.31	2.2	3.2	2.1	
	240	360	92	3.0	23048MB	23048MBK	816	2 120	184.8	530	670	35.5	H3048	AH3048	HM52T	0.23	3.0	4.5	2.9
360		92	3.0	23048CA	23048CAK	1 140	2 190	191.2	850	1 100	32.4	H3048	AH3048	HM52T	0.23	3.0	4.5	2.9	
360		92	3.0	23048CC	23048CCK	1 160	2 220	193.5	850	1 100	32.4	H3048	AH3048	HM52T	0.23	3.0	4.5	2.9	
360		118	3.0	24048CA	24048CAK	1 440	2 930	255.5	700	950	40.8	-	AOH24048	HM50T	0.3	2.3	3.4	2.2	
360		118	3.0	24048CC	24048CCK	1 490	2 930	255.5	700	950	40.8	-	AOH24048	HM50T	0.3	2.3	3.4	2.2	
400		128	4.0	23148MB	23148MBK	1 230	2 910	248.9	500	630	55.5	H3148	AH3148	HM52T	0.29	2.3	3.4	2.3	
400		128	4.0	23148CA	23148CAK	1 840	3 310	283.1	670	850	63.7	H3148	AH3148	HM52T	0.29	2.3	3.4	2.3	
400		128	4.0	23148CC	23148CCK	1 840	3 310	283.1	670	850	63.7	H3148	AH3148	HM52T	0.29	2.3	3.4	2.3	
400		128	4.0	24148CA	24148CAK	2 160	4 090	349.8	670	850	76.9	-	AOH24148	HM52T	0.38	1.8	2.7	1.8	
400		160	4.0	24148CC	24148CCK	2 160	4 090	349.8	670	850	76.9	-	AOH24148	HM52T	0.38	1.8	2.7	1.8	
440		120	4.0	22248CA	22248CAK	1 820	3 640	305.7	900	1 200	85.0	H3148	AH2248	HM52T	0.26	2.6	2.9	2.6	
440		160	4.0	23248CC	23248CCK	2 560	4 220	366.1	630	800	107.3	H2348	AH2348	HM52T	0.35	1.9	2.9	1.8	
440		160	4.0	23248CA	23248CAK	2 560	4 220	388.0	630	800	107.3	H2348	AH2348	HM52T	0.35	1.9	2.9	1.8	
500		155	5.0	22348CA	22348CAK	2 580	3 640	298.0	600	750	153.0	H2348	AH2348	HM52T	0.3	2.2	3.3	2.2	
260		400	104	4.0	23052CA	23052CAK	1 030	2 520	213.5	500	630	51.5	H3052	AH3052	HM56T	0.23	2.9	4.3	2.9
		400	104	4.0	23052CC	23052CCK	1 460	2 850	241.5	900	1 100	47.7	H3052	AH3052	HM56T	0.23	2.9	4.3	2.9
	400	104	4.0	23052CA	23052CAK	1 410	2 770	240.1	900	1 100	49.8	H3052	AH3052	HM56T	0.23	2.9	4.3	2.9	
	400	104	4.0	24052CA	24052CAK	1 790	3 850	326.2	630	850	66.7	-	AH24052	HM56T	0.32	2.1	3.1	2.1	
	400	140	4.0	24052CC	24052CCK	1 840	3 850	326.2	630	850	62.4	-	AH24052	HM56T	0.32	2.1	3.1	2.1	
	440	144	4.0	23152MB	23152MBK	1 470	3 410	283.9	450	560	95.3	H3152	AH3152	HM58T	0.32	2.0	3.1	2.0	
	440	144	4.0	23152CC	23152CCK	2 270	4 190	348.8	600	800	88.2	H3152	AH3152	HM58T	0.32	2.0	3.1	2.0	
	440	144	4.0	23152CA	23152CAK	2 230	4 050	344.6	600	800	88.9	H3152	AH3152	HM58T	0.32	2.0	3.1	2.0	
	440	180	4.0	24152CC	24152CCK	2 730	5 330	443.7	600	800	107.6	-	AH24152	HM56T	0.39	1.8	2.6	1.7	
	440	180	4.0	24152CA	24152CAK	2 660	5 220	437.1	600	800	115.0	-	AH24152	HM56T	0.39	1.8	2.6	1.7	
	480	130	5.0	22252CA	22252CAK	2 280	3 600	294.7	850	1 100	106.0	H3152	AH2252	HM58T	0.29	2.3	3.4	2.2	
	540	174	5.0	23252CC	23252CCK	2 910	4 750	397.9	630	800	145.0	H2352	AH2352	HM58T	0.37	1.8	2.6	1.7	
	540	174	5.0	23252CA	23252CAK	2 910	4 750	397.9	630	800	140.0	H2352	AH2352	HM58T	0.37	1.8	2.6	1.7	
	540	165	6.0	22352CA	22352CAK	2 860	4 310	344.7	480	700	191.0	H2352	AH2352	HM58T	0.3	2.3	3.4	2.2	

Double - Row Spherical Roller Bearings

d = 280 - 360 mm

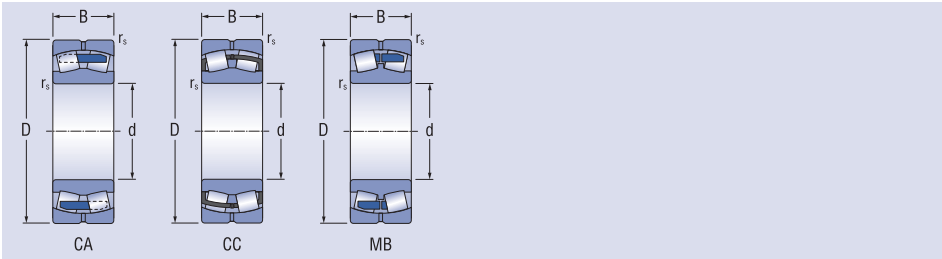

Dimensions	Bearing designation		Basic load rating	Fatigue load limit	Limiting speed	Mass	Corresponding			Coefficients									
	cylindrical bore	tapered bore					dynamic	static	for lubrication with grease	oil	Adapter sleeve	Withdrawal sleeve	Withdrawal nut	e	Y ₁	Y ₂	Y ₀		
d	D	B	r _s min	C _r	C _{0r}	C _u													
mm				kN			min ⁻¹	kg											
280	420	106	4.0	23056CA	23056CAK	1 110	2 760	242.6	700	900	62.0	H3056	AH3056	HM3060	0.22	3.0	4.5	3.0	
	420	106	4.0	23056CC	23056CCK	1 580	3 030	252.2	700	900	50.9	H3056	AH3056	HM3060	0.22	3.0	4.5	3.0	
	420	140	4.0	24056CA	24056CAK	1 940	4 100	341.3	600	800	69.2	-	AH24056	HM58T	0.3	2.2	3.3	2.2	
	420	140	4.0	24056CC	24056CCK	1 960	4 100	341.3	600	800	65.8	-	AH24056	HM58T	0.3	2.2	3.3	2.2	
	460	146	5.0	23156CA	23156CAK	2 380	4 410	361.0	560	750	104.0	H3156	AH3156	HM62T	0.29	2.3	3.5	2.3	
	460	146	5.0	23156CC	23156CCK	2 380	4 410	361.0	560	750	94.1	H3156	AH3156	HM62T	0.29	2.3	3.5	2.3	
	460	180	5.0	24156CA	24156CAK	2 745	5 480	448.7	560	750	119.0	-	AH24156	HM3160	0.37	1.8	2.7	1.8	
	460	180	5.0	24156CC	24156CCK	2 810	5 480	448.7	560	750	113.2	-	AH24156	HM3160	0.37	1.8	2.7	1.8	
	500	130	5.0	22256MB	22256MBK	2 150	3 480	280.5	800	900	112.3	H3156	AH2256	HM62T	0.28	2.4	3.5	2.3	
	500	130	5.0	22256CA	22256CAK	2 300	3 610	290.1	800	1 000	118.0	H3156	AH2256	HM62T	0.28	2.4	3.5	2.3	
	500	176	5.0	23256CA	23256CAK	3 120	5 100	411.0	600	750	147.0	H2356	AH2356	HM62T	0.36	1.9	2.7	1.8	
	580	175	6.0	22356CA	22356CAK	3 490	5 200	407.0	450	600	238.0	H2356	AH2356	HM62T	0.3	2.3	3.4	2.2	
	300	460	118	4.0	23060MB	23060MBK	1 290	3 160	256.6	430	530	75.2	H3060	AH3060	HM3064	0.23	3.0	4.4	2.9
		460	118	4.0	23060CC	23060CCK	1 910	3 800	325.1	800	1 000	73.6	H3060	AH3060	HM3064	0.23	3.0	4.4	2.9
460		160	4.0	24060CA	24060CAK	2 320	4 700	401.2	600	750	99.0	-	AH24060	HM62T	0.32	2.1	3.2	2.1	
460		160	4.0	24060CC	24060CCK	2 430	5 160	419.1	530	700	94.1	-	AH24060	HM62T	0.32	2.1	3.2	2.1	
500		160	5.0	23160MB	23160MBK	2 250	4 550	363.9	500	700	133.0	H3160	AH3160	HM66T	0.29	2.3	3.4	2.3	
500		160	5.0	23160CA	23160CAK	2 710	4 850	372.9	670	850	126.0	H3160	AH3160	HM66T	0.29	2.3	3.4	2.3	
500		200	5.0	24160CA	24160CAK	3 250	6 170	493.5	530	670	163.0	-	AH24160	HM3164	0.37	1.8	2.7	1.8	
500		200	5.0	24160CC	24160CCK	3 380	5 940	493.5	530	670	159.0	-	AH24160	HM3164	0.37	1.8	2.7	1.8	
540		140	5.0	22260CA	22260CAK	2 520	3 950	311.3	700	850	134.0	H3160	AH2260	HM66T	0.27	2.5	3.6	2.4	
540		192	5.0	23260CA	23260CAK	3 570	5 600	441.4	530	670	192.0	H3260	AH3260	HM66T	0.36	1.8	2.7	1.8	
480		121	4.0	23064CA	23064CAK	1 930	4 000	319.9	800	900	84.7	H3064	AH3064	HML69T	0.22	3.0	4.5	3.0	
480		160	4.0	24064CA	24064CAK	2 480	5 100	407.9	560	700	106.0	-	AOH24064	HM66T	0.3	2.2	3.3	2.2	
540		176	5.0	23164CA	23164CAK	3 150	5 200	406.9	630	700	200.0	H3164	AH3164	HM70T	0.3	2.2	3.3	2.2	
540		218	5.0	24164CC	24164CCK	3 620	6 810	533.0	480	600	208.0	-	AOH24164	HM3168	0.38	1.8	2.6	1.7	
580		150	5.0	22264CA	22264CAK	2 490	4 550	351.3	670	850	175.0	H3164	AH2264	HM70T	0.27	2.5	3.6	2.3	
580		208	5.0	23264CA	23264CAK	3 920	6 820	526.5	500	630	253.0	H3264	AH3264	HM70T	0.37	1.8	2.6	1.7	
340		520	133	5.0	23068CA	23068CAK	1 980	4 400	344.3	700	900	115.0	H3068	AH3068	HML73T	0.23	2.9	4.4	2.9
		520	180	5.0	24068CA	24068CAK	2 460	5 700	446.1	530	670	137.0	-	AOH24068	HM3072	0.33	2.0	3.0	2.0
	580	190	5.0	23168CA	23168CAK	3 050	6 300	483.2	600	750	206.0	H3168	AH3168	HM74T	0.3	2.2	3.3	2.2	
	580	243	5.0	24168CA	24168CAK	4 480	7 720	581.1	320	400	256.0	-	AOH24168	HM3172	0.4	1.7	2.5	1.7	
	620	224	6.0	23268CA	23268CAK	4 600	8 130	615.6	420	500	314.0	H3268	AH3268	HM74T	0.37	1.8	2.6	1.7	
360	540	134	5.0	23072CA	23072CAK	2 280	4 800	370.6	670	850	126.0	H3072	AH3072	HML77T	0.22	3.1	4.6	3.0	
	540	180	5.0	24072CA	24072CAK	3 050	6 370	491.8	450	560	150.0	-	AOH24072	HM76T	0.3	2.2	3.3	2.2	
	600	192	5.0	23172CA	23172CAK	3 250	6 850	518.7	590	700	255.0	H3172	AH3172	HM3180	0.3	2.3	3.4	2.2	
	600	243	5.0	24172CA	24172CAK	5 600	8 400	636.1	300	380	270.0	-	AH24172	HM3176	0.38	1.8	2.6	1.7	
	650	232	6.0	23272CA	23272CAK	4 650	8 300	619.0	400	500	330.0	H3272	AH3272	HM3180	0.35	1.8	2.6	1.7	

Double - Row Spherical Roller Bearings

d = 280 - 360 mm

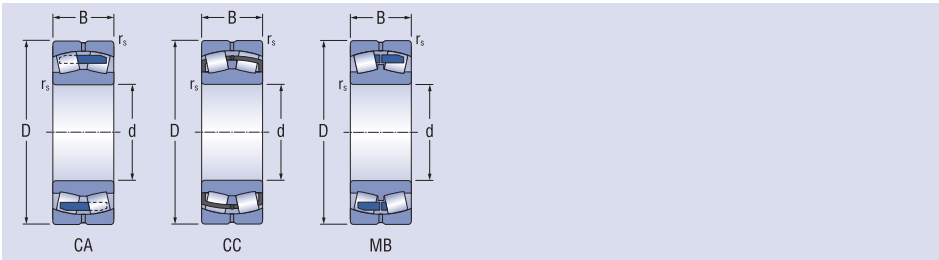

Dimensions				Bearing designation cylindrical bore tapered bore		Basic load rating dynamic static		Fatigue load limit	Limiting speed for lubrication with grease oil		Mass	Corresponding			Coefficients				
d	D	B	r _s min			C _r	C _{0r}	C _u				Adapter sleeve	Withdrawal sleeve	Withdrawal nut	e	Y ₁	Y ₂	Y ₀	
mm						kN			min ⁻¹		kg								
380	560	135	5.0	23076CA	23076CAK	2 480	5 000	381.0		630	800	130.0	H3076	AH3076	HML82T	0.21	3.2	4.7	3.1
	560	180	5.0	24076CA	24076CAK	3 150	6 800	518.2		480	600	153.0	-	AOH24076	HM3080	0.29	2.3	3.5	2.3
	620	194	5.0	23176CA	23176CAK	3 400	7 350	549.8		400	500	244.0	H3176	AH3176	HM3184	0.29	2.3	3.5	2.3
	620	243	5.0	24176CC	24176CCK	5 800	9 260	692.7		280	360	295.0	-	AOH24176	HM3180	0.36	1.9	2.7	1.8
	680	240	6.0	23276CA	23276CAK	5 200	9 350	287.3		380	480	395.0	H3276	AH3276	HM3184	0.36	1.9	2.7	1.8
400	600	148	5.0	23080CA	23080CAK	2 540	5 900	441.3		600	750	158.0	H3080	AH3080	HML86T	0.22	3.1	4.6	3.0
	600	200	5.0	24080CA	24080CAK	3 600	7 800	583.5		450	560	202.0	-	AOH24080	HM3084	0.3	2.2	3.3	2.2
	650	200	6.0	23180CA	23180CAK	4 080	7 650	563.9		380	480	275.0	H3180	AH3180	HM3188	0.28	2.4	3.8	2.4
	650	250	6.0	24180CA	24180CAK	5 100	9 800	722.4		180	240	336.0	-	AOH24180	HM3184	0.35	1.9	2.8	1.9
	720	256	6.0	23280CA	23280CAK	6 140	11 300	817.0		340	430	353.0	H3280	AH3280	HM3188	0.36	1.8	2.7	1.8



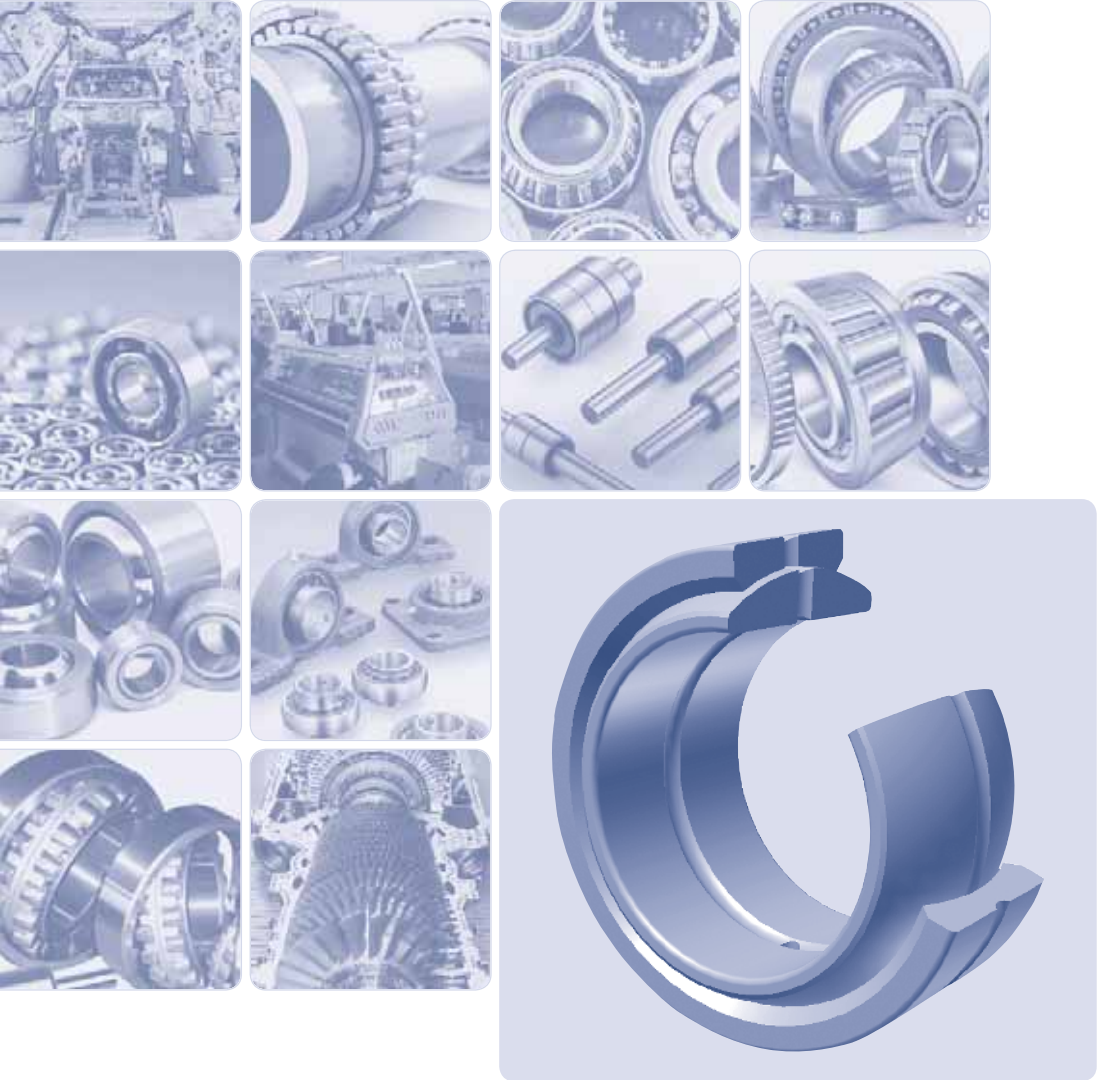

Spherical Plain Radial Bearings

Spherical Plain Bearings

Spherical Plain Bearings

Spherical plain bearings type GE are radial plain bearings which consist of one inner and one outer ring made of bearing steel, which have spherical sliding surfaces.

The bearings are suitable for arrangements with large radial loads and little tilting or swinging.

In addition, they can accommodate axial loads of a certain magnitude in both directions.

Boundary Dimensions

The boundary dimensions of GE-type spherical plain bearings comply with the ISO 12240-1 international standard.

Designation

The designation of spherical plain bearings with the standard design is given in the dimension table and consists of the type designation (GE) and size (the number indicates the internal diameter in mm), e.g. GE30.

Additional designation:

- Mark E – bearings with a phosphated surface, e.g. GE30E.
- Mark S – bearings with perimeter groove and two lubrication bores in the inner and an outer ring, e.g. GE30ES.

Mark ES means E + S.

Mark 2RS – bearings with a seal on both sides.

Precision

Spherical plain bearings are manufactured with normal precision grade, which is not designated. The deviation values comply with the ISO 12240-1 international standard.

Radial Clearance

Spherical bearings are normally manufactured with a normal radial play, which is not designated.

The values of radial clearances are given in the following table.

Bore diameter		Radial Play					
		C2		Normal		C3	
over	to	min.	max.	min.	max.	min.	max.
mm		µm					
2.5	12	8	32	32	68	68	104
12	20	10	40	40	82	82	124
20	35	12	50	50	100	100	150
35	60	15	60	60	120	120	180
60	90	18	72	72	142	142	212
90	140	18	85	85	165	165	245
140	200	180	100	100	192	192	284
200	240	18	110	110	214	214	318
240	300	18	125	125	239	239	353

Spherical Plain Bearings

d = 5 - 300 mm

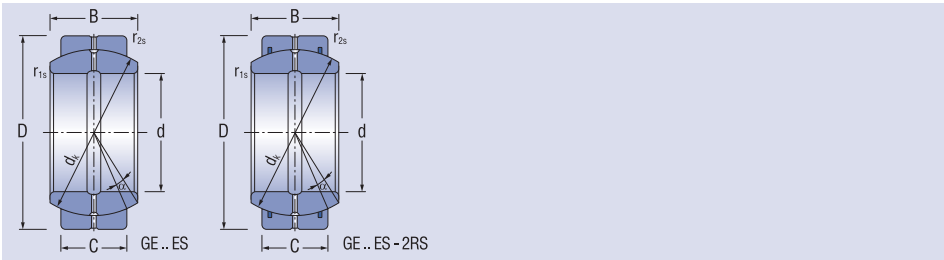

Dimensions								Designation	Basic load ratings		Mass	
d	D	B	C	dk	R1s min	R2s min	~α		dynamic	static		
mm							°		Cr	Cor	kg	
5	14	6	4	10	0.3	0.3	13	GE5E	3.4	17	0.005	
6	14	6	4	10	0.3	0.3	13	GE6E	3.4	17	0.004	
8	16	8	5	13	0.3	0.3	15	GE8E	5.5	27.5	0.007	
10	19	9	6	16	0.3	0.3	12	GE10E	8.2	40.5	0.011	
12	22	10	7	18	0.3	0.3	11	GE12E	10.8	54	0.016	
15	26	12	9	22	0.3	0.3	8	GE15ES	17	85	0.025	GE15ES-2RS
16	30	14	10	25	0.3	0.3	10	GE16ES	21.2	106	0.041	GE16ES-2RS
17	30	14	10	25	0.3	0.3	10	GE17ES	21.2	106	0.041	GE17ES-2RS
20	35	16	12	29	0.6	0.3	9	GE20ES	30	146	0.061	GE20ES-2RS
25	42	20	16	35.5	0.6	0.6	7	GE25ES	48	240	0.110	GE25ES-2RS
30	47	22	18	40.7	0.6	0.6	6	GE30ES	62	310	0.140	GE30ES-2RS
35	55	25	20	47	0.6	1.0	6	GE35ES	80	400	0.220	GE35ES-2RS
40	62	28	22	53	0.6	1.0	7	GE40ES	100	500	0.300	GE40ES-2RS
45	68	32	25	60	0.6	1.0	7	GE45ES	127	640	0.410	GE45ES-2RS
50	75	35	28	66	0.6	1.0	6	GE50ES	156	780	0.530	GE50ES-2RS
55	85	40	32	74	0.6	1.0	7	GE55ES	200	1000	0.940	GE55ES-2RS
60	90	44	36	80	1.0	1.0	6	GE60ES	245	1220	1.000	GE60ES-2RS
70	105	49	40	92	1.0	1.0	6	GE70ES	315	1560	1.500	GE70ES-2RS
80	120	55	45	105	1.0	1.0	6	GE80ES	400	2000	2.200	GE80ES-2RS
90	130	60	50	115	1.0	1.0	5	GE90ES	490	2450	2.700	GE90ES-2RS
100	150	70	55	130	1.0	1.0	7	GE100ES	610	3050	4.300	GE100ES-2RS
110	160	70	55	140	1.0	1.0	6	GE110ES	655	3250	4.700	GE110ES-2RS
120	180	85	70	160	1.0	1.0	6	GE120ES	950	4750	8.000	GE120ES-2RS
140	210	90	70	180	1.0	1.0	7	GE140ES	1080	5400	11.000	GE140ES-2RS
160	230	105	80	200	1.0	1.0	8	GE160ES	1360	6800	14.000	GE160ES-2RS
180	260	105	80	225	1.0	1.0	6	GE180ES	1530	7650	18.500	GE180ES-2RS
200	290	130	100	250	1.1	1.1	7	GE200ES	2120	10600	28.000	GE200ES-2RS
220	320	135	100	275	1.1	1.1	8	GE220ES	2320	11600	35.510	GE220ES-2RS
240	340	140	100	300	1.1	1.1	8	GE240ES	2550	12700	39.910	GE240ES-2RS
260	370	150	110	325	1.1	1.1	7	GE260ES	3030	15190	51.540	GE260ES-2RS
280	400	155	120	350	1.1	1.1	6	GE280ES	3570	17850	65.060	GE280ES-2RS
300	430	165	120	375	1.1	1.1	7	GE300ES	3800	19100	78.070	GE300ES-2RS



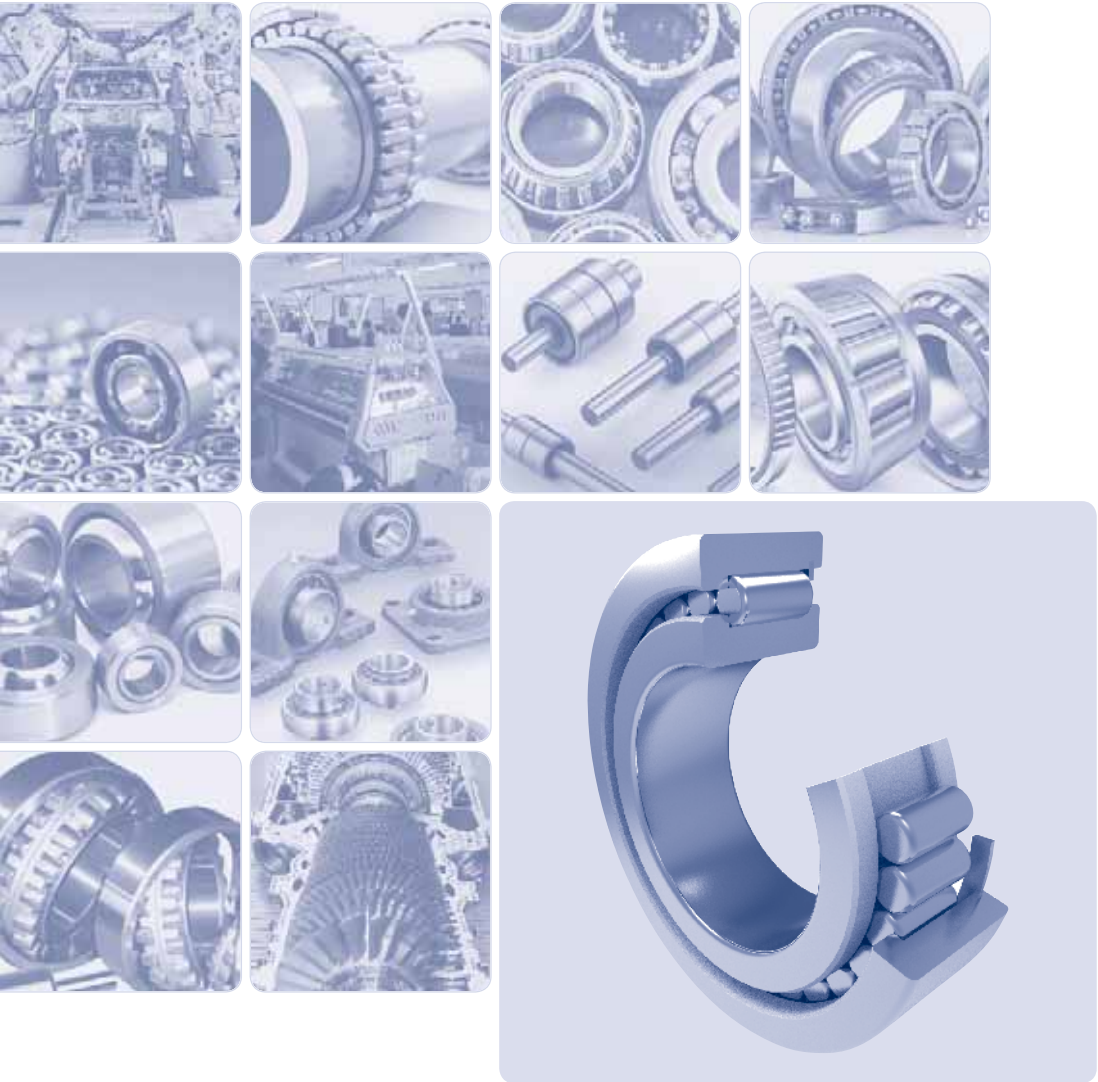

**Single-row full-complement
cylindrical roller bearings**

Single-row full-complement cylindrical roller bearings

Single-row full-complement cylindrical roller bearings

Single-row full-complement cylindrical roller bearings are suitable for arrangements with a large radial load and lower speeds compared to cylindrical roller bearings with a cage. Full-complement cylindrical roller bearings have the largest possible number of rollers and are without a cage. Additional designation V.

Single-row full-complement cylindrical roller bearings are manufactured in two designs.

NCF Design

The inner ring of the bearing has guiding flanges on both sides. The outer ring has one guiding flange. The NCF design bearing is axially guiding in one direction. The bearing accommodates axial load in one direction and accommodates axial displacement of the shaft relative to the housing in the opposite direction. The outer ring has a retaining ring on the side without the guiding flange, which secures the components in the mounted state. The NCF design corresponds to the SL1818, SL1819, SL1830 and SL1822 designs of INA bearings.

NJG Design

The outer ring of the bearing has guiding flanges on both sides. The inner ring has one guiding flange. The NJG design bearing is axially guiding in one direction. The bearing accommodates axial load in one direction and accommodates axial displacement of the shaft relative to the housing in the opposite direction. The NJG bearing is a dismountable bearing. When the inner ring is removed, the rollers hold together with the outer ring due to the optimal alignment of the raceway diameter of the outer ring and the diameter and number of rollers. The NJG design bearings belong to the heavy 23 dimension series. The NJG design corresponds to the SL1923 design of INA bearings.

Boundary Dimensions

The boundary dimensions of single-row full-complement cylindrical roller bearings given in the dimension tables comply with the ISO 15 international dimension plan.

Precision

Single-row full-complement cylindrical roller bearings are normally manufactured with the normal precision grade P0, which is not designated. Limiting values for dimensional and running accuracy deviations are given in ISO 492.

Designation

The designation of bearings with the basic design is given in the dimension tables. The difference from the basic design is designated by additional marks according to STN 02 4608. The table section also contains the designation of the INA design with matches for individual bearings.

Radial Clearance

Single-row full-complement cylindrical roller bearings are manufactured with a normal radial clearance, which is not designated. Bearings with reduced (C2) or increased (C3, C4, C5) radial clearance are available for special arrangements. The values of radial clearance comply with ISO 5753-1 and are valid for bearings in the unmounted state.

Permissible Misalignment

The permissible misalignment of single-row full-complement cylindrical roller bearings is subject to the same conditions as standard single-row cylindrical roller bearings with a cage (see the Single-row Cylindrical Roller Bearings chapter).

Operating Temperatures

For arrangements with an operating temperature higher than 120°C, bearings are supplied with specially heat-treated components, which ensure dimensional and shape stability even with long-term exposure to higher temperatures from 150°C to 400°C (S0, S1, S2, S3, S4). The supply of stabilised bearings needs to be negotiated in advance with the supplier.

Minimum Load

For single-row full-complement cylindrical roller bearings, a minimum radial load corresponding to 4% of the basic dynamic bearing capacity is recommended. Cylindrical roller bearings work reliably when axial loads are applied if the bearings are radially loaded at the same time. The $F_a/F_r \leq 0.5$ ratio must be observed.

Dynamic and Static Equivalent Bearing Load

Dynamic Equivalent Bearing Load

If full-complement cylindrical roller bearings are used exclusively with a radial load without axial forces, the dynamic load is calculated as follows:

$$P_r = F_r$$

If the bearings are also used to accommodate axial forces, the dynamic loads are calculated as follows:

Where:

e = calculation coefficient

e = 0.2 for NCF series bearings (18)

e = 0.3 for NCF (22, 29, 30) and NJG (23) series bearings

Y = axial load coefficient

Y = 0.6 for NCF series bearings (18)

Y = 0.4 for NCF (22, 29, 30) and NJG (23) series bearings

Static Equivalent Bearing Load

The following applies to statically loaded cylindrical roller bearings:

$$P_{0r} = F_r$$

Single-row full-complement cylindrical roller bearings

d = 20 - 75 mm

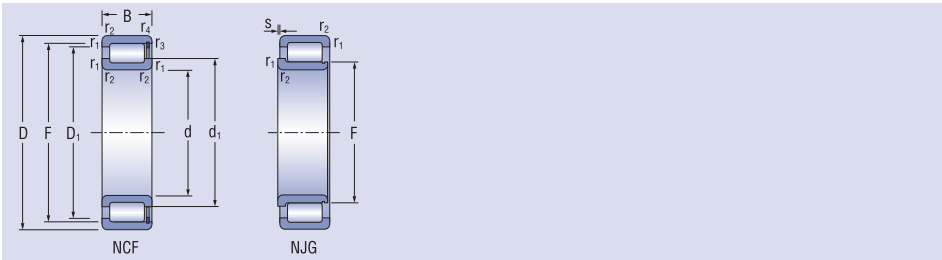

Dimensions									Bearing designation		Basic load rating		Fatigue load limit	Limiting speed		Mass of Bearings
d	D	B	r _s min	s	F	E	d ₁ ≈	D ₁ ≈		INA	C _r	C _{or}	C _u	for lubrication with grease	oil	kg
mm											kN			min ⁻¹		
20	42	16	0.6	1.5	-	36.5	29	33	NCF3004V	SL183004	28.0	30.6	3.7	7 400	10 000	0.11
	47	18	1.0	1	-	41.5	30	37	NCF2204V	SL182204	30.3	29.4	3.6	6 400	9 500	0.16
25	47	16	0.6	1.5	-	42.5	34.5	38.5	NCF3005V	SL183005	31.2	34.4	4.2	6 100	9 000	0.12
	52	18	1.0	1	-	46.5	35	42	NCF2205V	SL182205	38.9	38.5	4.7	5 400	8 500	0.18
	62	24	1.1	2	31.72	-	36.5	47.5	NJG2305V	SL192305	57.5	56.5	6.9	4 700	7 500	0.37
30	55	19	1.0	2	-	49.5	40	45	NCF3006V	SL183006	40.3	45.0	5.5	5 500	7 500	0.20
	62	20	1.0	1	-	55	42	50.5	NCF2206V	SL182206	60.8	66.2	8.8	4 500	7 000	0.30
	72	27	1.1	2	38.3	-	43.5	56	NJG2306V	SL192306	79.5	83.7	10.2	4 900	6 500	0.56
35	62	20	1.0	2	-	55.5	45	51	NCF3007V	SL183007	51.9	63.4	7.7	4 800	6 500	0.26
	72	23	1.1	1	-	64	47	59	NCF2207V	SL182207	91.8	97.5	11.9	4 200	6 000	0.44
	80	31	1.5	2	44.68	-	51	65.5	NJG2307V	SL192307	114	121	14.7	3 700	5 500	0.74
40	68	21	1.0	2	-	61.5	50.5	57.5	NCF3008V	SL183008	54.1	64.1	7.8	5 000	6 000	0.31
	80	23	1.1	1	-	71	54	66	NCF2208V	SL182208	97.1	107	13.8	4 400	5 500	0.55
	90	33	1.5	2	51.12	-	57.5	75	NJG2308V	SL192308	148	159	19.4	3 600	5 000	1.01
45	75	23	1.0	2	-	66.5	55.5	62	NCF3009V	SL183009	63.9	81.8	10.0	5 000	5 500	0.40
	85	23	1.1	1	-	74.5	57.5	69.5	NCF2209V	SL182209	112	131	15.9	4 400	5 500	0.55
	100	36	1.5	3	56.1	-	62.5	80	NJG2309V	SL192309	157	175	21.3	2 900	4 500	1.37
50	80	23	1.0	2	-	72	59	67.5	NCF3010V	SL183010	74.3	93.7	11.4	3 500	5 000	0.43
	90	23	1.1	1	-	81.5	64.5	76.5	NCF2210V	SL182210	121	149	18.1	3 000	4 600	0.64
	110	40	2.0	3	60.72	-	68.5	89.5	NJG2310V	SL192310	162	177	23.2	2 700	4 100	1.81
55	90	26	1.1	2	-	83.5	68.5	78.5	NCF3011V	SL183011	93.3	122	14.9	3 100	4 500	0.64
	100	25	1.5	1	-	89	70	83.5	NCF2211V	SL182211	120	151	18.5	2 700	4 100	0.87
	120	43	2.0	3	67.11	-	75.5	99	NJG2311V	SL192311	183	220	26.9	2 300	3 700	2.28
60	85	16	1.0	1	-	78.5	69	84.5	NCF2912V	SL182912	50.4	74.7	9.1	2 800	4 500	0.29
	95	26	1.1	2	-	86.5	71.5	81.5	NCF3012V	SL183012	96.0	129	15.7	2 900	4 200	0.69
	110	28	1.5	1.5	-	99	77	93	NCF2212V	SL182212	148	184	22.4	2 500	3 800	1.18
	130	46	2.1	3	73.62	-	82	105.5	NJG2312V	SL192312	232	275	33.5	2 200	3 400	2.88
65	90	16	1.0	1	-	85	75.5	81	NCF2913V	SL182913	55.7	82.5	10.7	2 600	4 200	0.31
	100	26	1.1	2	-	93	78	88	NCF3013V	SL183013	101	141	17.2	2 800	3 900	0.73
	120	31	1.5	1.5	-	106	82.5	100	NCF2213V	SL182213	172	218	26.6	2 400	3 500	1.57
	140	48	2.1	3.5	80.69	-	90	116.5	NJG2313V	SL192313	252	303	36.8	2 100	3 200	3.52
70	100	19	1.0	1	-	92.5	81	87.5	NCF2914V	SL182914	71.2	107	13.1	2 500	3 800	0.49
	110	30	1.1	3	-	100	81.5	95	NCF3014V	SL183014	132	178	21.7	2 700	3 600	1.02
	125	31	1.5	1.5	-	111	87	105	NCF2214V	SL182214	1523	198	24.2	2 300	3 300	1.66
	150	51	2.1	3.5	84.14	-	93.5	121.5	NJG2314V	SL192314	277	346	41.6	2 000	2 900	4.33
75	105	19	1.0	1	-	97.5	86	93	NCF2915V	SL182915	74.3	114	13.9	2 300	3 600	0.52
	115	30	1.1	3	-	107.5	89	102.5	NCF3015V	SL183015	140	196	23.9	2 500	3 400	1.06
	130	31	1.5	1.5	-	116	91.5	110	NCF2215V	SL182215	185	245	29.9	2 100	3 200	1.75
	160	55	2.1	3.5	91.22	-	101.5	131.5	NJG2315V	SL192315	336	403	47.1	1 900	2 700	5.30

Single-row full-complement cylindrical roller bearings

d = 80 - 160 mm

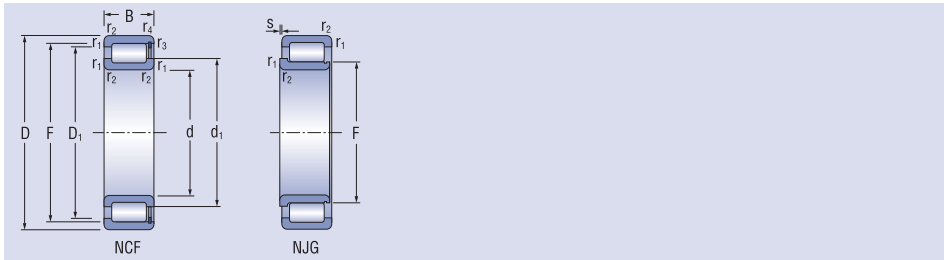

Dimensions									Bearing designation		Basic load rating		Fatigue load limit	Limiting speed		Mass of Bearings
d	D	B	r _s min	s	F	E	d ₁ ≈	D ₁ ≈		INA	C _r	C _{or}	C _u	for lubrication with grease	oil	kg
mm											kN			min ⁻¹		
80	110	19	1.0	1	-	102	91	98	NCF2916V	SL182916	81.9	126	15.3	2 200	3 400	0.55
	125	34	1.1	4	-	117	95	111	NCF3016V	SL183016	169	230	27.8	2 400	3 200	1.43
	140	33	2.0	1.5	-	126	98.5	119	NCF2216V	SL182216	210	271	32.2	2 000	2 900	2.15
	170	58	2.1	3.5	98.24	-	109.5	142	NJG2316V	SL192316	354	438	50.3	1 800	2 600	6.32
85	120	22	1.1	1	-	109	96	105	NCF2917V	SL182917	102	157	19.2	2 100	3 200	0.81
	130	34	1.1	4	-	121	99.5	115.5	NCF3017V	SL183017	173	242	28.9	2 300	3 000	1.51
	150	36	2.0	1.5	-	133	104.5	126	NCF2217V	SL182217	248	329	38.4	1 900	2 800	2.74
	180	60	3.0	4	107.01	-	118	150.5	NJG2317V	SL192317	389	504	56.7	1 700	2 400	7.34
90	125	22	1.0	1	-	115	102	110.5	NCF2918V	SL182918	104	163	19.6	2 000	3 000	0.84
	140	37	1.5	4	-	130	106	124	NCF3018V	SL183018	202	287	33.5	2 200	2 800	1.97
	160	40	2.0	2.5	-	140.5	110	133	NCF2218V	SL182218	268	357	41.0	1 900	2 600	3.48
	190	64	3.0	4	105.26	-	117	152	NJG2318V	SL192318	445	545	61.0	1 600	2 300	8.83
95	130	22	1.1	1	-	122	106.5	117	NCF2919V	SL182919	107	174	20.5	1 900	2 900	0.86
	170	43	2.1	2.5	-	155.5	122	147	NCF2219V	SL182219	311	429	47.8	1 800	2 400	4.17
	200	67	3.0	4	114.65	-	126.5	161.5	NJG2319V	SL192319	493	634	69.5	1 500	2 200	10.2
100	140	24	1.1	1.5	-	130	113.5	125.5	NCF2920V	SL182920	130	204	23.6	1 800	2 700	1.14
	150	37	1.5	4	-	139	115.5	133.5	NCF3020V	SL183020	213	314	35.9	2 000	2 600	2.15
	180	46	2.1	2.5	-	163	127.5	154	NCF2220V	SL182220	406	541	59.8	1 700	2 300	5.13
	215	73	3.0	4	119.3	-	132.5	172.5	NJG2320V	SL192320	572	715	77.0	1 400	2 100	13.0
110	150	24	1.1	1.5	-	141	124	136	NCF2922V	SL182922	131	213	24.0	1 600	2 500	1.23
	170	45	2.0	5.5	-	156	127.5	149	NCF3022V	SL183022	280	407	45.0	1 900	2 300	3.5
	200	53	2.1	4	-	177	137.5	167	NCF2222V	SL182222	421	582	62.5	1 600	2 100	7.24
	240	80	3.0	5	134.27	-	151	199.5	NJG2322V	SL192322	664	890	93.1	1 200	1 900	17.0
120	165	27	1.1	1.5	-	154	135	148.5	NCF2924V	SL182924	170	288	31.6	1 500	2 300	1.73
	180	46	2.0	5.5	-	167	139	160.5	NCF3024V	SL183024	295	445	48.2	1 800	2 200	3.8
	215	58	2.1	4	-	192.5	150.5	182	NCF2224V	SL182224	480	668	69.9	1 500	1 900	9.08
	260	86	3.0	5	147.39	-	164	213	NJG2324V	SL192324	806	1 050	106.3	1 100	1 700	22.3
130	180	30	1.5	2	-	166	146	161	NCF2926V	SL182926	214	354	38.1	1 500	2 100	2.33
	200	52	2.0	5.5	-	183	148.5	175	NCF3026V	SL183026	330	511	53.7	1 700	2 000	5.65
	230	64	3.0	5	-	207	162.5	196	NCF2226V	SL182226	560	790	80.9	1 000	1 800	11.25
140	190	30	1.5	2	-	179	157	173.5	NCF2928V	SL182928	221	380	39.8	1 400	2 000	2.42
	210	53	2.0	5.5	-	197	162.5	189	NCF3028V	SL183028	336	537	55.0	1 500	1 900	6.04
	250	68	3.0	5	-	222	174	210	NCF2228V	SL182228	625	890	89.1	950	1 700	14.47
150	190	19	0.6	01 1	-	179.5	164.2	175.2	NCF1830V	SL181830	108	197	20.5	1 300	1 700	1.30
	210	36	2.0	2.5	-	196.5	185.5	224	NCF2930V	SL182930	280	490	50.0	1 500	1 800	3.77
	225	56	2.1	7	-	207	169	189	NCF3030V	SL183030	390	625	63.1	1 500	1 700	7.33
	270	73	3.0	6	-	237	189	224	NCF2230V	SL182230	765	1 037	101.2	1 200	1 500	18.43
160	200	20	0.6	1.1	-	189	173	185	NCF1832V	SL181832	112	209	21.4	1 200	1 600	1.70
	220	36	2.0	2.5	-	207.6	179.7	200.5	NCF2932V	SL182932	302	514	51.7	1 300	1 700	4.0
	240	60	2.1	7	-	225.45	184.8	215.8	NCF3032V	SL183032	530	628	62.2	1 300	1 600	8.8
	290	80	3.0	6	-	267.1	210	253	NCF2232V	SL182232	990	1 490	142.5	1 000	1 500	23.0

Single-row full-complement cylindrical roller bearings

d = 170 - 360 mm

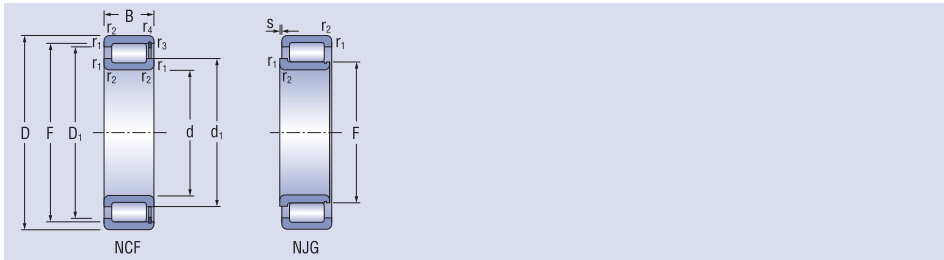

Dimensions									Bearing designation		Basic load rating		Fatigue load limit	Limiting speed for lubrication with grease oil		Mass of Bearings
d	D	B	r _s min	s	F	E	d ₁ ≈	D ₁ ≈		INA	C _r	C _{or}	C _u			kg
mm											kN			min ⁻¹		
170	215	22	0.6	01 1	-	204.5	185	200	NCF1834V	SL181834	149	272	27.3	1 300	1 600	1.80
	230	36	2.0	02 5	-	218.45	190.6	211.3	NCF2934V	SL182934	311	576	57.1	1 200	1 600	4.3
	260	67	2.1	7	-	243.55	198.1	232.7	NCF3034V	SL183034	681	1 040	100.8	1 100	1 500	12.2
	310	86	4.0	7	-	281.9	220	268	NCF2234V	SL182234	1 090	1 680	157.6	900	1 400	28.65
180	225	22	0.6	01 1	-	215.2	196	211	NCF1836V	SL181836	153	290	28.6	1 200	1 400	1.90
	250	42	2.0	3	-	231.85	200.7	224	NCF2936V	SL182936	397	709	68.7	1 200	1 500	6.2
	280	74	2.1	7	-	261	212.2	249.4	NCF3036V	SL183036	788	1 270	120.6	1 000	1 400	16.1
	320	86	4.0	7	-	294	233	279	NCF2236V	SL182236	1 130	1 780	164.9	850	1 300	29.8
190	230	23	1.1	01 5	-	229	208	224	NCF1838V	SL181838	176	330	32.2	1 100	1 400	2.30
	260	42	2.0	2	-	244.15	211.5	238.5	NCF2938V	SL182938	410	753	72.0	1 100	1 400	6.5
	290	75	2.1	9	-	270.6	221.8	259	NCF3038V	SL183038	809	1 330	124.7	1 000	1 400	17.0
	340	92	4.0	9	-	309.5	244	295	NCF2238V	SL182238	1 240	1 970	179.3	800	1 200	35.65
200	250	24	1.5	2	-	237.6	216.6	231.6	NCF1840V	SL181840	179	343	32.8	1 200	1 400	2.57
	280	48	2.1	3	-	261.6	225.5	252.4	NCF2940V	SL182940	498	924	86.7	1 000	1 400	9.1
	310	82	2.1	9	-	288.6	236.6	276.2	NCF3040V	SL183040	925	1 540	141.8	900	1 300	21.8
	360	98	4.0	9	-	325	262	308	NCF2240V	SL182240	1 390	2 230	199.7	800	1 200	43.12
220	270	24	1.5	2	-	258.5	237.3	252.3	NCF1844V	SL181844	188	377	35.1	1 000	1 300	2.8
	300	48	2.1	3	-	282.45	246.3	273.2	NCF2944V	SL182944	522	1 010	92.5	850	1 200	9.9
	340	90	3.0	9	-	313.1	254.6	299.2	NCF3044V	SL183044	1 110	1 840	164.8	850	1 200	28.4
	400	108	4.0	8	-	366	277	349	NCF2244V	SL182244	1 720	2 740	238.0	750	1 100	58.0
240	300	28	2.0	2	-	287.5	260.5	281	NCF1848V	SL181848	264	520	47.1	950	1 200	4.4
	320	48	2.1	3	-	303.7	267.5	294.4	NCF2948V	SL182948	544	1 090	97.6	750	1 200	10.6
	360	92	3.0	11	-	336	277.5	322.1	NCF3048V	SL183048	1 170	2 010	176.3	750	1 100	30.9
260	350	33	2.0	02 5	-	308	281	301.5	NCF1852V	SL181852	275	561	49.0	850	1 100	4.71
	360	60	2.1	5	-	333.7	291.5	323.4	NCF2952V	SL182952	764	1 490	129.4	700	1 000	18.5
	400	104	4.0	11	-	375.97	304	358.4	NCF3052V	SL183052	1 590	2 640	225.0	650	1 000	44.5
280	350	33	2.0	02 5	-	335	304	327	NCF1856V	SL181856	335	682	58.9	800	1 000	7.0
	380	60	2.1	03 5	-	359.5	314	348.5	NCF2956V	SL182956	887	1 750	149.2	600	1 000	19.7
	420	106	4.0	11	-	390.3	319.5	372.9	NCF3056V	SL183056	1 630	2 770	232.0	600	950	48.0
300	380	38	2.1	3	-	360	323.5	350.5	NCF1860V	SL181860	428	858	72.5	700	950	10.0
	420	72	3.0	5	-	389.45	338	376.9	NCF2960V	SL182960	1 130	2 240	186.0	550	900	31.2
	460	118	4.0	14	-	434.85	353.6	415.6	NCF3060V	SL183060	2 000	3 560	290.9	500	850	66.6
320	400	38	2.1	3	-	381	344.5	371.5	NCF1864V	SL181864	442	912	75.7	650	900	10.6
	440	72	3.0	5	-	409.85	358.5	397.4	NCF2964V	SL182964	1 170	2 380	194.5	500	850	32.9
	480	121	4.0	14	-	449.5	369.5	430.1	NCF3064V	SL183064	2 050	3 720	299.3	500	800	71.7
340	420	38	2.1	3	-	402.2	365.5	392.5	NCF1868V	SL181868	455	966	78.9	650	850	11.2
	460	72	3.0	5	-	430.2	379	418.7	NCF2968V	SL182968	1 210	2 520	202.8	480	800	34.7
	520	133	5.0	16	-	485.65	396.1	463.9	NCF3068V	SL183068	2 410	4 570	359.8	450	750	95.8
360	440	38	2.1	3	-	423.5	387	413.5	NCF1872V	SL181872	468	1 010	81.3	550	800	11.7
	480	72	3.0	5	-	450.6	399.5	438.6	NCF2972V	SL182972	1 240	2 660	210.9	440	750	36.4
	540	134	5.0	16	-	503.45	414	481.6	NCF3072V	SL183072	2 440	4 460	346.4	430	700	101.0

Single-row full-complement cylindrical roller bearings

d = 380 - 500 mm

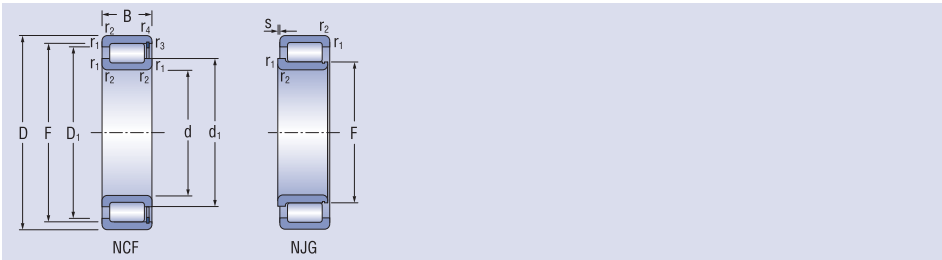

Dimensions									Bearing designation		Basic load rating		Fatigue load limit	Limiting speed for lubrication with grease/oil		Mass of Bearings
d	D	B	r _s min	s	F	E	d ₁ ≈	D ₁ ≈		INA	C _r	C _{or}	C _u			
mm											kN			min ⁻¹		kg
380	480	46	2.1	4	-	459	415.5	448	NCF1876V	SL181876	650	1 360	107.1	550	750	19.2
	520	82	4.0	5	-	486.7	426	472.1	NCF2976V	SL182976	1 490	3 160	245.4	400	700	52.1
	560	135	5.0	16	-	521.25	431.7	499.5	NCF3076V	SL183076	2 500	4 650	356.5	410	700	106.0
400	500	46	2.1	4	-	475.5	432	464.5	NCF1880V	SL181880	664	1 420	110.3	490	700	20.0
	540	82	4.0	5	-	510.85	450	496.1	NCF2980V	SL182980	1 530	3 330	255.3	370	700	54.3
	600	148	5.0	18	-	558.52	462.5	535.1	NCF3080V	SL183080	2 980	5 520	415.4	360	650	140.0
420	520	46	2.1	4	-	500	457	489.5	NCF1884V	SL181884	684	1 500	115.0	470	700	20.9
	560	82	4.0	5	-	524	462	509	NCF2984V	SL 182984	1 750	3 510	265.7	360	650	56.9
440	540	46	2.1	4	-	517	473.5	506	NCF1888V	SL181888	697	1 560	118.1	440	650	21.8
	600	95	4.0	7	-	562	490	544.6	NCF2988V	SL 182988	2 040	4 480	333.2	330	600	78.1
460	580	56	3.0	5	-	554	501.5	541	NCF1892V	SL181892	945	2 020	150.2	420	600	33.9
	620	95	4.0	7	-	576.3	504	559.6	NCF2992V	SL 182992	2 070	4 600	338.2	320	600	81.1
480	600	56	3.0	5	-	474.5	522	561	NCF1896V	SL181896	965	2 100	154.4	400	600	35.2
	650	100	5.0	7	-	614.75	538	596.6	NCF2996V	SL 182996	2 310	5 110	370.7	290	550	94.7
500	620	56	3.0	5	-	594.5	542	581.5	NCF18/500V	SL1818/500	985	2 190	159.3	380	600	36.5
	670	100	5.0	7	-	630	553	612.7	NCF29/500V	SL 1829/500	2 380	7 510	539.1	280	550	98.3



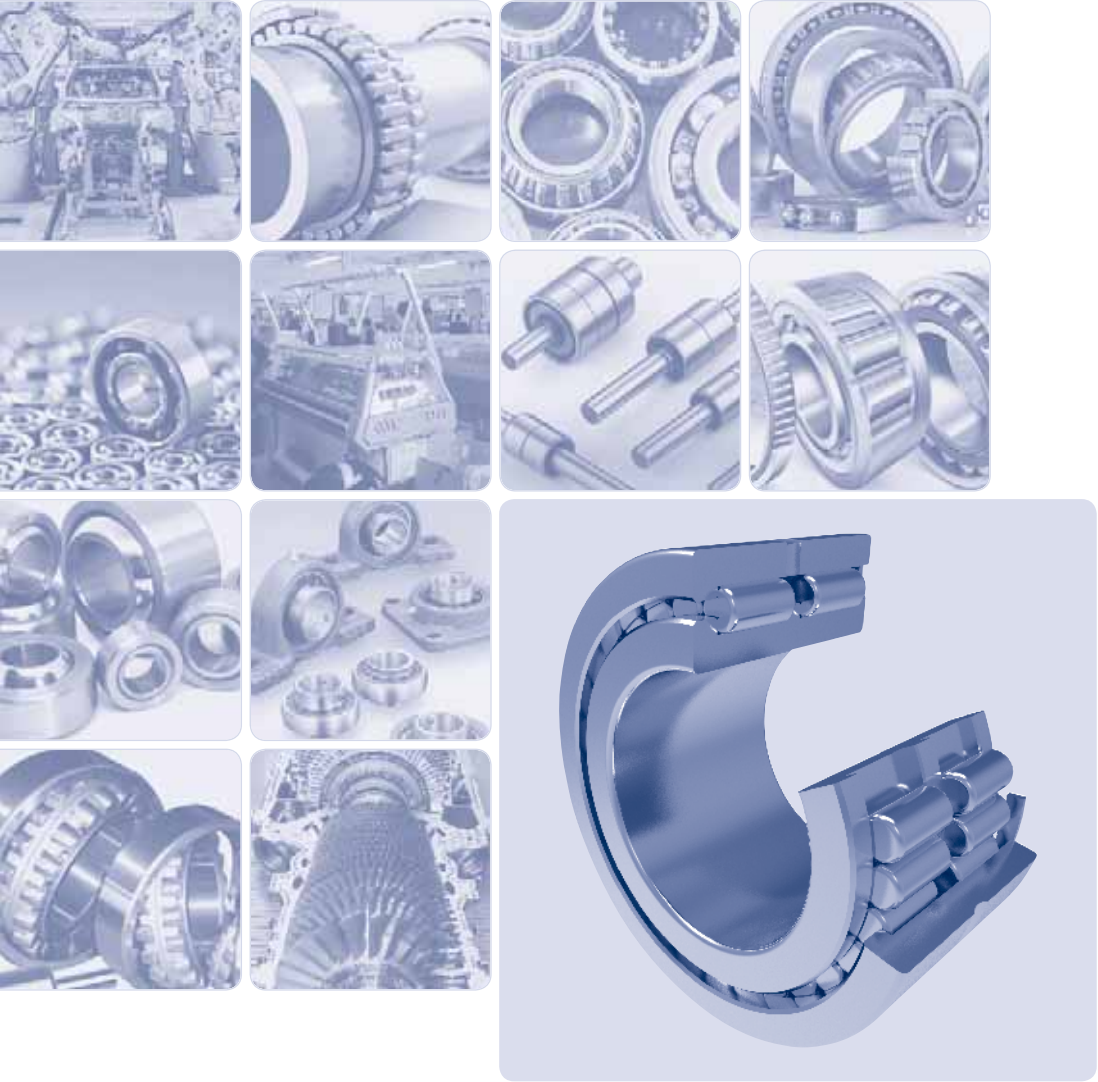

**Double-row full-complement
cylindrical roller bearings**

Double-row full-complement cylindrical roller bearings

Double-row full-complement cylindrical roller bearings

Double-row full-complement cylindrical roller bearings are suitable for arrangements with a large radial load and lower speeds compared to cylindrical roller bearings with a cage. Full-complement cylindrical roller bearings have the largest possible number of rollers and are without a cage. Additional designation V.

Double-row full-complement cylindrical roller bearings are all made with an additional lubrication groove and bores on the outer ring, which allows perfect access of lubricant to the rolling space of each roller row.

Double-row full-complement cylindrical roller bearings are manufactured in four designs, which are not dismountable.

NNCL Design

The inner ring of the bearing has three guiding flanges. The outer ring has no guiding flange. The bearing is kept in the mounted state by a retaining ring located in the outer ring between the rows of rollers. The NNCL bearing is axially loose, allowing axial displacement of the shaft relative to the housing. The NNCL design corresponds to the SL0248 and SL0249 designs of INA bearings.

NNCF Design

The inner ring of the bearing has three guiding flanges. The outer ring has one guiding flange and there is a retaining ring on the opposite side to secure the components in the mounted state. The NNCF design bearing is axially guiding in one direction and may accommodate axial load on the side of the guiding flange. The NNCF design corresponds to the SL1850 design of INA bearings.

NNC Design

The inner ring of the bearing has three guiding flanges. The outer ring is divided and has two guiding flanges. The outer ring is held together by retaining rings, which should not be loaded axially. The NNC design bearing is axially guiding in both directions. The NNC design corresponds to the SL0148 and SL0149 designs of INA bearings.

NNF Design

The inner ring is divided and each has guiding flanges, held together by an elastic ring.

The outer ring has a guiding flange. They can accommodate axial forces in both directions. These bearings can accommodate tilting moments because of the greater distance between the rows of rollers.

The outer ring of NNF bearings is 1 mm narrower than the inner ring and has two grooves. As a standard, the bearings are supplied with seals on both sides and the inner space is filled with lubricant, which ensures the operation of the bearings in normal working conditions up to 110°C.

Boundary Dimensions

The boundary dimensions of double-row full-complement cylindrical roller bearings given in the dimension tables comply with the ISO 15 international dimension plan.

Designation

The designation of bearings with the basic design is given in the dimension tables. The difference from the basic design is designated by additional marks according to STN 02 4608. The table section also contains the designation of the INA design with matches for individual bearings.

Precision

Double-row full-complement cylindrical roller bearings are normally manufactured with the normal precision grade P0, which is not designated. The bearings can also be manufactured with a higher precision grade P6. The availability of these bearings needs to be consulted with the supplier. Limiting values for dimensional and running accuracy deviations are given in ISO 492.

Radial Clearance

Double-row full-complement cylindrical roller bearings are manufactured with a normal radial clearance, which is not designated. Bearings with reduced (C2) or increased (C3, C4, C5) radial clearance are available for special arrangements. The values of radial clearance comply with ISO 5753-1 and are valid for bearings in the unmounted state.

Axial Clearance

The NNC design bearings that are axially guiding in both directions must have a certain axial clearance that ranges from 0.1 to 0.2 mm for all bearing sizes.

Axial Displacement

The NNCL and NNCF designs of double-row full-complement cylindrical roller bearings are able to compensate axial displacement of the shaft relative to the housing to a certain extent, without reducing the bearing life. The values of the maximum axial displacement "s" are given in the dimension tables.

Permissible Misalignment

The misalignment of the inner ring of double-row full-complement cylindrical roller bearings relative to the outer ring leads to moment load in the bearing, which results in increased load and shorter bearing life.

Operating Temperatures

For arrangements with an operating temperature higher than 120°C, bearings are supplied with specially heat-treated components, which ensure dimensional and shape stability even with long-term exposure to higher temperatures from 150°C to 400°C (S0, S1, S2, S3, S4). The supply of such bearings needs to be negotiated in advance.

For double-row full-complement cylindrical roller bearings, minimum radial load corresponding to 4% of the basic dynamic bearing capacity is recommended.

Cylindrical roller bearings work reliably when axial loads are applied if the bearings are radially loaded at the same time. The $F_a/F_r \leq 0.25$ ratio must be observed.

Dynamic and Static Equivalent Bearing Load

Dynamic Equivalent Bearing Load

If cylindrical roller bearings are used exclusively with radial load without axial forces, the dynamic load is calculated as follows:

$$P_r = F_r$$

If the bearings are also used to accommodate axial forces, the dynamic loads are calculated as follows:

$$P_r = F_r \quad \text{for } F_a/F_r \leq e$$

$$P_r = 0.92 \cdot F_r + Y \cdot F_a \quad \text{for } F_a/F_r > e$$

Where:

e = calculation coefficient
e = 0.15 for double-row bearings

Y = axial load coefficient
Y = 0.4 for double-row bearings

Static Equivalent Bearing Load

The following applies to statically loaded cylindrical roller bearings:

$$P_{0r} = F_r$$

Double-row full-complement cylindrical roller bearings

d = 20 - 120 mm

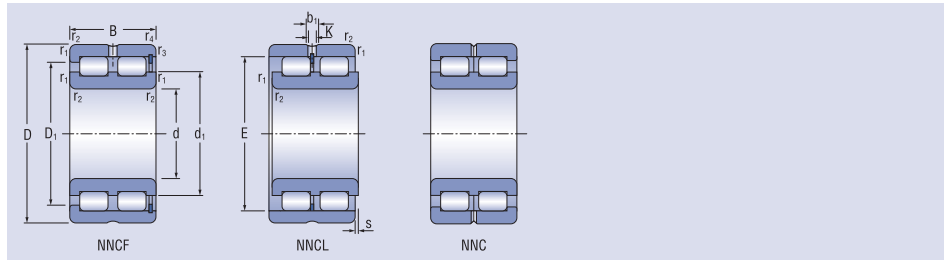

Dimensions									Bearing designation		Basic load rating		Fatigue load limit	Limiting speed for lubrication with grease/oil		Mass of Bearings
d	D	B	r _{sm}	s	C	d1	D1	E	INA	C _r	C _{or}	C _u	min ⁻¹		kg	
mm										kN						
20	42	30	0.6	1	15	28.4	33.3	36.81	NNCF5004V	SL185004	47.10	55.80	6.80	7 000	8 300	0.20
25	47	30	0.6	1	15	34.5	39.0	42.51	NNCF5005V	SL185005	53.50	68.70	8.40	5 700	6 800	0.23
30	55	34	1.0	1.5	17	40.0	45.3	49.60	NNCF5006V	SL185006	69.10	90.00	11.00	6 200	7 300	0.35
35	62	36	1.0	1.5	18	44.9	51.2	55.52	NNCF5007V	SL185007	83.60	113.60	13.80	4 300	5 100	0.46
40	68	38	1.0	1.5	19	50.5	57.2	61.74	NNCF5008V	SL185008	99.60	140.90	17.20	3 900	4 800	0.56
45	75	40	1.0	1.5	20	55.3	62.6	66.85	NNCF5009V	SL185009	105.80	156.70	19.10	3 400	4 300	0.71
50	80	40	1.0	1.5	20	59.1	67.6	72.33	NNCF5010V	SL185010	131.30	193.30	23.60	3 200	4 000	0.76
55	90	46	1.1	1.5	23	68.5	78.7	83.54	NNCF5011V	SL185011	177.50	279.80	34.10	2 700	3 500	1.16
60	85	25	1.0	1	12.5	70.5	73.5	77.51	NNCF4912V	SL184912	71.20	132.00	16.10	2 800	3 400	0.50
	85	25	1.0	-	12.5	70.3	73.5	-	NNC4912V	SL014912	71.20	132.00	16.10	2 800	3 400	0.49
	85	25	1.0	1	12.5	70.3	-	77.51	NNCL4912V	SL024912	71.20	132.00	16.10	2 800	3 400	0.47
	95	46	1.1	1.5	23	71.7	81.9	86.74	NNCF5012V	SL185012	182.50	293.90	35.80	2 700	3 200	1.24
65	100	46	1.1	1.5	23	78.1	88.3	93.09	NNCF5013V	SL185013	192.30	322.00	39.30	2 400	2 900	1.32
70	100	30	1.0	1	15	83.0	87.0	91.87	NNCF4914V	SL184914	107.10	197.40	24.10	2 400	2 900	0.77
	100	30	1.0	-	15	82.5	87.4	-	NNC4914V	SL014914	106.90	197.60	24.10	2 400	2 900	0.78
	100	30	1.0	1	15	82.5	-	91.87	NNCL4914V	SL024914	106.90	197.60	24.10	2 400	2 900	0.75
	110	54	1.1	3	27	81.5	95.7	100.28	NNCF5014V	SL185014	226.30	356.80	43.50	2 200	2 700	1.85
75	115	54	1.1	3	27	89.0	102.9	107.90	NNCF5015V	SL185015	239.00	392.60	47.90	2 100	2 500	1.93
80	110	30	1.0	1	15	91.4	96.0	100.78	NNCF4916V	SL184916	113.40	220.10	26.80	2 100	2 500	0.87
	110	30	1.0	-	15	91.4	96.2	-	NNC4916V	SL014916	113.40	220.10	26.80	2 100	2 500	0.88
	110	30	1.0	1	15	91.4	-	100.78	NNCL4916V	SL024916	113.40	220.30	26.80	2 100	2 500	0.85
	125	60	1.1	3.5	30	95.0	111.7	117.40	NNCF5016V	SL185016	288.70	460.60	55.60	1 950	2 300	2.59
85	130	60	1.1	3.5	30	99.0	121.95	121.95	NNCF5017V	SL185017	297.00	483.80	57.60	1 950	2 300	2.72
90	125	35	1.1	1.5	17.5	103	111	115.20	NNCF4918V	SL184918	152.50	306.40	36.60	1 950	2 300	1.35
	125	35	1.1	-	17.5	103.9	110.7	-	NNC4918V	SL014918	152.50	306.40	36.60	1 950	2 300	1.35
	125	35	1.1	1.5	17.5	103	-	115.20	NNCL4918V	SL024918	152.50	306.40	36.60	1 950	2 300	1.30
	140	67	1.5	4	33.5	106.1	124.5	130.65	NNCF5018V	SL185018	346.00	573.50	66.90	1 700	2 100	3.62
100	140	40	1.1	2	20	116	125	129.60	NNCF4920V	SL184920	194.30	400.00	46.20	1 600	1 900	1.95
	140	40	1.1	-	20	116.4	125	-	NNC4920V	SL014920	194.30	400.00	46.20	1 600	1 900	1.95
	140	40	1.1	2	20	116.4	-	129.60	NNCL4920V	SL024920	194.30	400.00	46.20	1 600	1 900	1.90
	150	67	1.5	4	33.5	115.7	134	140.20	NNCF5020V	SL185020	364.50	628.30	71.60	1 600	1 900	3.94
110	150	40	1.1	2	20	125	134	138.20	NNCF4922V	SL184922	202.10	431.00	48.70	1 500	1 800	2.10
	150	40	1.1	-	20	125	133.6	-	NNC4922V	SL014922	202.10	431.00	48.70	1 500	1 800	2.15
	150	40	1.1	2	20	125	-	138.20	NNCL4922V	SL024922	202.10	431.00	48.70	1 500	1 800	2.10
	170	80	2.0	5	40	127.3	149.3	156.70	NNCF5022V	SL185022	319.60	483.00	53.40	1 450	1 700	6.32
120	165	45	1.1	3	22.5	139	149	153.55	NNCF4924V	SL184924	225.60	479.10	52.30	1 350	1 600	2.90
	165	45	1.1	-	22.5	138.6	148.6	-	NNC4924V	SL014924	225.60	479.10	52.30	1 350	1 600	2.95
	165	45	1.1	3	22.5	138.6	-	153.55	NNCL4924V	SL024924	225.60	479.10	52.30	1 350	1 600	2.85
	180	80	2.0	5	40	138.8	160.7	168.15	NNCF5024V	SL185024	505.10	891.70	96.20	1 350	1 600	6.77

Double-row full-complement cylindrical roller bearings

d = 130 - 180 mm

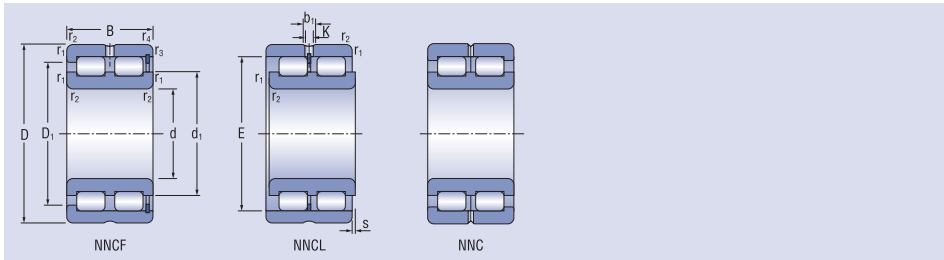

Dimensions									Bearing designation		Basic load rating		Fatigue load limit	Limiting speed		Mass of Bearings
d	D	B	r _{sm}	s	C	d1 ≈	D1 ≈	E		INA	C _r	C _{or}	C _u	for lubrication with grease	oil	kg
mm											kN			min ⁻¹		
130	180	50	1.5	4	25	149	160	165.40	NNCF4926V	SL184926	261.80	554.00	59.20	1 250	1 500	3.90
	180	50	1.5	-	25	148.4	160	-	NNC4926V	SL014926	261.80	554.00	59.20	1 250	1 500	3.95
	180	50	1.5	4	25	149.5	-	165.40	NNCL4926V	SL024926	261.80	554.00	59.20	1 250	1 500	3.80
	200	95	2.0	5	47.5	148.6	175.5	184.40	NNCF5026V	SL185026	716.20	1 247.30	131.50	1 200	1 400	10.20
140	190	50	1.5	4	25	160	171	175.90	NNCF4928V	SL184928	272.00	594.50	62.40	1 200	1 400	4.15
	190	50	1.5	-	25	159	170.5	-	NNC4928V	SL014928	272.00	594.50	62.40	1 200	1 400	4.20
	190	50	1.5	4	25	160	-	175.90	NNCL4928V	SL024928	272.00	594.50	62.40	1 200	1 400	4.10
	210	95	2.0	5	47.5	162.6	189.5	198.40	NNCF5028V	SL185028	756.80	1 372.60	141.20	1 100	1 300	11.10
150	190	40	1.1	2	20	165	174	178.30	NNCF4830V	SL184830	234.30	575.10	59.90	1 200	1 400	2.80
	190	40	1.1	-	20	165.1	174.2	-	NNC4830V	SL014830	234.30	575.10	59.90	1 200	1 400	2.90
	190	40	1.1	2	20	165.1	-	178.30	NNCL4830V	SL024830	234.30	575.10	59.90	1 200	1 400	2.80
	210	60	2.0	4	30	171	187	192.77	NNCF4930V	SL184930	405.10	853.60	87.50	1 100	1 300	6.55
	210	60	2.0	-	30	171.8	187.2	-	NNC4930V	SL014930	405.10	853.60	87.50	1 100	1 300	6.65
	210	60	2.0	4	30	171.8	-	192.77	NNCL4930V	SL024930	405.10	853.60	87.50	1 100	1 300	6.45
160	225	100	2.0	6	50	170	198	207.45	NNCF5030V	SL185030	793.80	1 435.00	145.60	1 000	1 200	13.30
	200	40	1.1	2	20	174	182	186.90	NNCF4832V	SL184832	240.40	606.60	61.90	1 100	1 300	3.00
	200	40	1.1	-	20	173.7	182.8	-	NNC4832V	SL014832	240.40	606.60	61.90	1 100	1 300	3.10
	200	40	1.1	2	20	173.7	-	186.90	NNCL4832V	SL024832	240.40	606.60	61.90	1 100	1 300	3.00
	220	60	2.0	4	30	184	200	206.16	NNCF4932V	SL184932	422.40	922.50	92.80	1 000	1 200	6.90
	220	60	2.0	-	30	184.2	200.3	-	NNC4932V	SL014932	422.40	922.50	92.80	1 000	1 200	7.00
	220	60	2.0	4	30	184.2	-	206.16	NNCL4932V	SL024932	422.40	922.50	92.80	1 000	1 200	6.80
170	240	109	2.1	6	54.5	184	216	224.80	NNCF5032V	SL185032	909.60	1 655.30	164.00	930	1 100	15.80
	215	45	1.1	3	22.5	187	197	201.30	NNCF4834V	SL184834	264.70	650.60	65.30	1 000	1 200	4.00
	215	45	1.1	-	22.5	186.3	197	-	NNC4834V	SL014834	264.70	650.60	65.30	1 000	1 200	4.10
	215	45	1.1	3	22.5	186.3	-	201.30	NNCL4834V	SL024834	264.70	650.60	65.30	1 000	1 200	3.95
	230	60	2.0	4	30	193	209	206.16	NNCF4934V	SL184934	433.80	968.70	96.20	930	1 100	7.20
	230	60	2.0	-	30	193.1	209.1	-	NNC4934V	SL014934	433.80	968.70	96.20	930	1 100	7.35
	230	60	2.0	4	30	193.1	-	215.08	NNCL4934V	SL024934	433.80	968.70	96.20	930	1 100	7.10
	260	122	2.1	6	61	198	232	243.00	NNCF5034V	SL185034	1 168.40	2 160.00	209.40	850	1 000	23.00
180	225	45	1.1	3	22.5	200	210	214.10	NNCF4836V	SL184836	274.40	696.30	68.50	930	1 100	4.20
	225	45	1.1	-	22.5	199.1	209.8	-	NNC4836V	SL014836	274.40	696.30	68.50	930	1 100	4.30
	225	45	1.1	3	22.5	199.1	-	214.10	NNCL4836V	SL024836	274.40	696.30	68.50	930	1 100	4.15
	250	69	2.0	4	34.5	205	224	230.50	NNCF4936V	SL184936	558.00	1 247.50	121.10	850	1 000	10.50
	250	69	2.0	-	34.5	204.9	224.1	-	NNC4936V	SL014936	558.00	1 247.50	121.10	850	1 000	10.80
	250	69	2.0	4	34.5	204.9	-	230.50	NNCL4936V	SL024936	558.00	1 247.50	121.10	850	1 000	10.50
	280	136	2.1	8	68	212	249	260.50	NNCF5036V	SL185036	1 350.50	2 534.80	240.70	850	1 000	30.50

Double-row full-complement cylindrical roller bearings

d = 190 - 280 mm

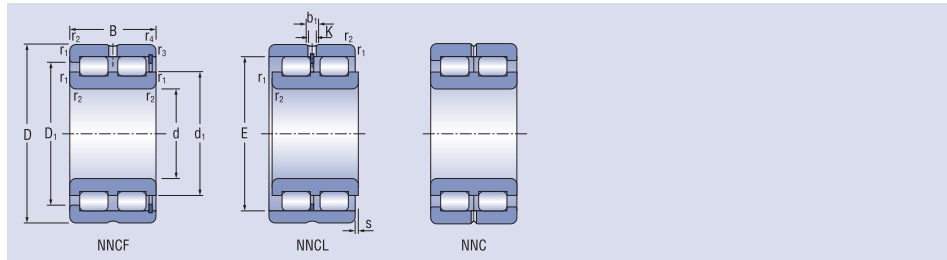

Dimensions									Bearing designation		Basic load rating		Fatigue load limit	Limiting speed		Mass of Bearings
d	D	B	r _{sm}	s	C	d1	D1	E	INA	C _r	C _{or}	C _u	for lubrication with grease	oil	kg	
mm	mm	mm	mm	mm	mm	mm	mm	mm		kN	kN	kN	min ⁻¹	min ⁻¹		
190	240	50	1.5	4	25	209	221	225	NNCF4838V	SL184838	313.30	784.30	76.10	850	1 000	5.50
	240	50	1.5	-	25	207.6	220.7	-	NNC4838V	SL014838	313.30	784.30	76.10	850	1 000	5.65
	240	50	1.5	4	25	207.6	-	225	NNCL4838V	SL024838	313.30	784.30	76.10	850	1 000	5.45
	260	69	2.0	4	34.5	215	234	240.70	NNCF4938V	SL184938	572.00	1 312.20	125.40	850	1 000	11.00
	260	69	2.0	-	34.5	215	234.3	-	NNC4938V	SL014938	572.00	1 312.20	125.40	850	1 000	11.20
	260	69	2.0	4	34.5	215	-	240.70	NNCL4938V	SL024938	572.00	1 312.20	125.40	850	1 000	10.90
200	290	136	2.1	8	68	222	258	270	NNCF5038V	SL185038	1 386.90	2 656.10	249.10	800	950	31.50
	250	50	1.5	4	25	219	231	235.50	NNCF4840V	SL184840	322.10	824.70	78.90	850	1 000	5.80
	250	50	1.5	-	25	218.1	231.2	-	NNC4840V	SL014840	322.10	824.70	78.90	850	1 000	5.90
	250	50	1.5	4	25	218.1	-	235.50	NNCL4840V	SL024840	322.10	824.70	78.90	850	1 000	5.70
	280	80	2.1	5	40	230	252	259.34	NNCF4940V	SL184940	671.80	1 514.40	141.80	800	950	15.50
	280	80	2.1	-	40	230.5	252.3	-	NNC4940V	SL014940	671.80	1 514.40	141.80	800	950	15.80
220	280	80	2.1	5	40	230.5	-	259.34	NNCL4940V	SL024940	671.80	1 514.40	141.80	800	950	15.30
	310	150	2.1	9	75	236	276	288.00	NNCF5040V	SL185040	1 635.20	3 202.80	294.70	800	950	41.00
	270	50	1.5	4	25	239	252	256.50	NNCF4844V	SL184844	338.10	906.00	84.40	800	1 000	6.30
	270	50	1.5	-	25	239.1	252.3	-	NNC4844V	SL014844	338.10	906.00	84.40	800	1 000	6.40
	270	50	1.5	4	25	239.1	-	256.50	NNCL4844V	SL024844	338.10	906.00	84.40	800	1 000	6.20
	300	80	2.1	5	40	248	269	276.52	NNCF4944V	SL184944	696.60	1 631.70	149.50	800	1 000	17.00
240	300	80	2.1	-	40	248	268.5	-	NNC4944V	SL014944	696.60	1 631.70	149.50	800	1 000	17.20
	300	80	2.1	5	40	248	-	276.52	NNCL4944V	SL024944	696.60	1 631.70	149.50	800	1 000	16.70
	340	160	3.0	9	80	255	300	312.20	NNCF5044V	SL185044	1 903.60	3 676.40	330.50	720	850	52.50
	300	60	2.0	4	30	259	277	281.90	NNCF4848V	SL184848	506.10	1 316.80	119.60	750	900	9.90
	300	60	2.0	-	30	259.5	276.7	-	NNC4848V	SL014848	506.10	1 316.80	119.60	750	900	10.00
	300	60	2.0	4	30	259.5	-	281.90	NNCL4848V	SL024848	506.10	1 316.80	119.60	750	900	9.90
260	320	80	2.1	5	40	270	292	299.46	NNCF4948V	SL184948	731.70	1 787.00	159.80	720	850	18.50
	320	80	2.1	-	40	270.6	292.3	-	NNC4948V	SL014948	731.70	1 787.00	159.80	720	850	18.50
	320	80	2.1	5	40	270.6	-	299.46	NNCL4948V	SL024948	731.70	1 787.00	159.80	720	850	17.90
	360	160	3.0	9	80	278	322	335.60	NNCF5048V	SL185048	2 005.10	4 028.40	353.60	680	800	56.00
	320	60	2.0	4	30	282	299	304.20	NNCF4852V	SL184852	528.50	1 432.80	126.90	680	800	11.00
	320	60	2.0	-	30	281.8	298.8	-	NNC4852V	SL014852	528.50	1 432.80	126.90	680	800	11.00
280	320	60	2.0	4	30	281.8	-	304.20	NNCL4852V	SL024852	528.50	1 432.80	126.90	680	800	10.60
	360	100	2.1	6	50	294	322	331.33	NNCF4952V	SL184952	1 082.90	2 548.60	221.80	630	750	31.50
	360	100	2.1	-	50	294.5	322.1	-	NNC4952V	SL014952	1 082.90	2 548.60	221.80	630	750	32.00
	360	100	2.1	6	50	294.5	-	331.33	NNCL4952V	SL024952	1 082.90	2 548.60	221.80	630	750	31.20
	400	190	4.0	10	95	304	357	373.50	NNCF5052V	SL185052	2 656.70	5 115.30	435.60	590	700	85.50
	350	69	2.0	4	34.5	307	326	332.40	NNCF4856V	SL184856	693.00	1 889.60	163.10	630	750	16.00
280	350	69	2.0	-	34.5	306.8	326.4	-	NNC4856V	SL014856	693.00	1 889.60	163.10	630	750	16.00
	350	69	2.0	4	34.5	306.8	-	332.40	NNCL4856V	SL024856	693.00	1 889.60	163.10	630	750	15.60
	380	100	2.1	6	50	316	345	353.34	NNCF4956V	SL184956	1 126.20	2 745.30	234.00	590	700	33.50
	380	100	2.1	-	50	316.5	344.6	-	NNC4956V	SL014956	1 126.20	2 745.30	234.00	590	700	34.00
	380	100	2.1	6	50	316.5	-	353.34	NNCL4956V	SL024956	1 126.20	2 745.30	234.00	590	700	33.10
	420	190	4.0	10	95	320	372	389.00	NNCF5056V	SL185056	2 731.60	5 372.50	451.70	570	670	90.50

Double-row full-complement cylindrical roller bearings

d = 300 - 400 mm

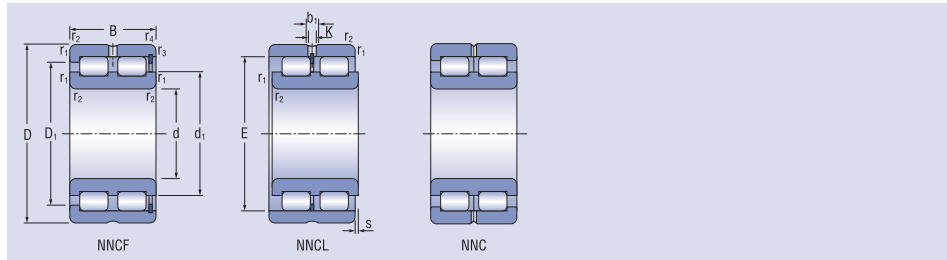

Dimensions									Bearing designation		Basic load rating		Fatigue load limit	Limiting speed for lubrication with grease oil		Mass of Bearings
d	D	B	r _{sm}	s	C	d1 ≈	D1 ≈	E	INA	C _r	C _{or}	C _u	min ⁻¹		kg	
mm										kN						
300	380	80	2.1	6	40	328	350	356.70	NNCF4860V	SL184860	810.00	2 177.10	184.00	590	700	22.50
	380	80	2.1	-	40	327.9	349.9	-	NNC4860V	SL014860	810.00	2 177.10	184.00	590	700	23.00
	380	80	2.1	6	40	327.9	-	356.70	NNCL4860V	SL024860	810.00	2 177.10	184.00	590	700	22.00
	420	118	3.0	6	59	341	374	385.51	NNCF4960V	SL184960	1 585.90	3 819.50	316.60	570	670	52.50
320	420	118	3.0	-	59	340.7	374.3	-	NNC4960V	SL014960	1 585.90	3 819.50	316.60	570	670	53.00
	420	118	3.0	6	59	340.7	-	385.51	NNCL4960V	SL024960	1 585.90	3 819.50	316.60	570	670	51.90
	460	218	4.0	9	109	352	418	433.00	NNCF5060V	SL185060	3 383.50	6 795.80	553.70	510	600	130.00
	400	80	2.1	6	40	351	373	379.70	NNCF4864V	SL184864	841.30	2 332.90	193.30	530	630	23.50
340	400	80	2.1	-	40	350.9	372.9	-	NNC4864V	SL014864	841.30	2 332.90	193.30	530	630	24.00
	400	80	2.1	6	40	350.9	-	379.70	NNCL4864V	SL024864	841.30	2 332.90	193.30	530	630	23.50
	440	118	3.0	6	59	368	401	412.27	NNCF4964V	SL184964	1 657.70	4 123.00	336.60	510	600	55.50
	440	118	3.0	-	59	367.5	401.1	-	NNC4964V	SL014964	1 657.70	4 123.00	336.60	510	600	56.00
	440	118	3.0	6	59	367.5	-	412.27	NNCL4964V	SL024964	1 657.70	4 123.00	336.60	510	600	54.90
	480	218	4.0	9	109	370	434	449.00	NNCF5064V	SL185064	3 438.10	7 025.00	565.40	470	560	135.00
	420	80	2.1	6	40	368	390	396.90	NNCF4868V	SL184868	859.20	2 450.00	200.20	510	600	25.00
360	420	80	2.1	-	40	368.1	390.1	-	NNC4868V	SL014868	859.20	2 450.00	200.20	510	600	25.50
	420	80	2.1	6	40	368.1	-	396.90	NNCL4868V	SL024868	859.20	2 450.00	200.20	510	600	25.00
	460	118	3.0	6	59	385	419	430.11	NNCF4968V	SL184968	1 702.30	4 330.20	348.60	470	560	58.50
	460	118	3.0	-	59	385.3	418.9	-	NNC4968V	SL014968	1 702.30	4 330.20	348.60	470	560	59.00
	460	118	3.0	6	59	385.3	-	430.11	NNCL4968V	SL024968	1 702.30	4 330.20	348.60	470	560	57.80
	520	243	5.0	11	121.5	395	468	485.00	NNCF5068V	SL185068	4 140.00	8 434.20	664.20	530	530	185.00
	440	80	2.1	6	40	391	413	419.80	NNCF4872V	SL184872	889.60	2 605.60	209.30	470	560	26.50
380	440	80	2.1	-	40	391	413.2	-	NNC4872V	SL014872	889.60	2 605.60	209.30	470	560	27.00
	440	80	2.1	6	40	391	-	419.80	NNCL4872V	SL024872	889.60	2 605.60	209.30	470	560	26.00
	480	118	3.0	6	59	404	437	447.95	NNCF4972V	SL184972	1 743.40	4 538.10	360.30	450	530	61.50
	480	118	3.0	-	59	404	436.8	-	NNC4972V	SL014972	1 743.40	4 538.10	360.30	450	530	62.10
	480	118	3.0	6	59	404	-	447.95	NNCL4972V	SL024972	1 743.40	4 538.10	360.30	450	530	60.80
	540	243	5.0	11	121.5	412	486	503.00	NNCF5072V	SL185072	4 250.70	8 838.00	687.60	420	500	195.00
	480	100	2.1	6	50	419	447	455.80	NNCF4876V	SL184876	1 305.70	3 663.60	287.80	450	530	45.00
400	480	100	2.1	-	50	419	447.2	-	NNC4876V	SL014876	1 305.70	3 663.60	287.80	450	530	45.50
	480	100	2.1	6	50	419	-	455.80	NNCL4876V	SL024876	1 305.70	3 663.60	287.80	450	530	44.00
	520	140	4.0	7	70	430	469	481.35	NNCF4976V	SL184976	2 218.20	5 754.20	447.00	420	500	91.50
	520	140	4.0	-	70	430.2	468.7	-	NNC4976V	SL014976	2 218.20	5 754.20	447.00	420	500	92.40
	520	140	4.0	7	70	430.2	-	481.35	NNCL4976V	SL024976	2 218.20	5 754.20	447.00	420	500	90.50
	560	243	5.0	11	121.5	431	504	521.00	NNCF5076V	SL185076	4 360.00	9 242.00	710.60	400	480	200.00
	500	100	2.1	6	50	434	462	470.59	NNCF4880V	SL184880	1 328.80	3 794.50	295.20	420	500	46.00
	500	100	2.1	-	50	433.8	462	-	NNC4880V	SL014880	1 328.80	3 794.50	295.20	420	500	46.50
400	500	100	2.1	6	50	433.8	-	470.59	NNCL4880V	SL024880	1 328.80	3 794.50	295.20	420	500	45.80
	540	140	4.0	7	70	451	489	501.74	NNCF4980V	SL184980	2 274.30	6 035.80	462.70	400	480	95.50
	540	140	4.0	-	70	450.5	489	-	NNC4980V	SL014980	2 274.30	6 035.80	462.70	400	480	96.50
	540	140	4.0	7	70	450.5	-	501.74	NNCL4980V	SL024980	2 274.30	6 035.80	462.70	400	480	94.50
	600	272	5.0	11	136	460	540	558.00	NNCF5080V	SL185080	4 695.30	9 900.00	745.80	380	450	270.00

Double-row full-complement cylindrical roller bearings type NNF50.. (SL04..)

d = 20 - 220 mm

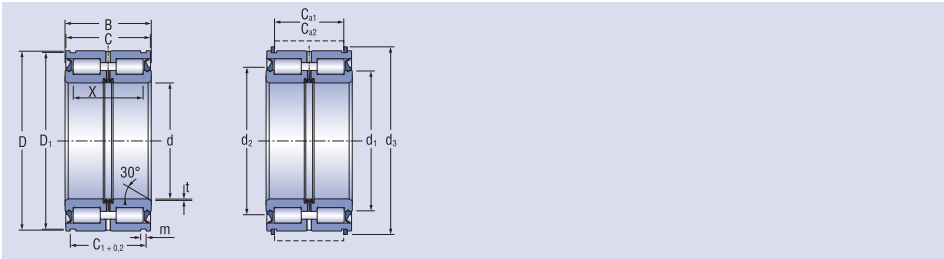

Dimensions															Bearing designation		Basic load rating		Fatigue load limit		
d	D	B	C	C ₁	D ₁	m	r _{sm}	t	x	C _{a1} ¹⁾	C _{a2} ²⁾	d ₁	d ₂	d ₃			C _r	C _{0r}	C _u		
mm																	kN				
20	42	30	29	24.7	40.2	1.8	0.3	0.5	22.5	21.5	21	30.55	34	47			SL045004-PP2NR	NNF 5004	40.6	46.0	5.6
25	47	30	29	24.7	45.2	1.8	0.3	0.5	22.5	21.5	21	35.35	39	52			SL045005-PP2NR	NNF 5005	46.5	57.0	7.0
30	55	34	33	28.2	53	2.1	0.3	0.5	25.5	25	24	40.6	44	60			SL045006-PP2NR	NNF 5006	57.5	74.6	9.1
35	62	36	35	30.2	60	2.1	0.3	0.5	27.5	27	26	46.1	50	67			SL045007-PP2NR	NNF 5007	65.2	82.1	10.2
40	68	38	37	32.2	65.8	2.7	0.6	0.8	28.5	28	27	51.4	55	75			SL045008-PP2NR	NNF 5008	67.9	90.0	11.0
45	75	40	39	34.2	72.8	2.7	0.6	0.8	30.5	30	29	57	61	82			SL045009-PP2NR	NNF 5009	102.1	143.8	17.5
50	80	40	39	34.2	77.8	2.7	0.6	0.8	30.5	30	29	61.8	66	87			SL045010-PP2NR	NNF 5010	108.9	160.2	19.5
55	90	46	45	40.2	87.4	3.2	0.6	1.0	36	35	34	68.6	73	99			SL045011-PP2NR	NNF 5011	129.5	191.8	23.4
60	95	46	45	40.2	92.4	3.2	0.6	1.0	36	35	34	73.7	79	104			SL045012-PP2NR	NNF 5012	137.3	211.3	25.8
65	100	46	45	40.2	97.4	3.2	0.6	1.0	36	35	34	78.8	84	109			SL045013-PP2NR	NNF 5013	140.4	221.9	27.6
70	110	54	53	48.2	107.1	4.2	0.6	1.0	42	43	40	84.5	91	119			SL045014-PP2NR	NNF 5014	197.0	318.6	38.9
75	115	54	53	48.2	112.1	4.2	0.6	1.0	42	43	40	89.95	97	124			SL045015-PP2NR	NNF 5015	195.8	321.0	39.1
80	125	60	59	54.2	122.1	4.2	0.6	1.5	48	49	46	97.1	105	137			SL045016-PP2NR	NNF 5016	244.3	412.1	49.9
85	130	60	59	54.2	127.1	4.2	0.6	1.5	48	49	46	103.9	112	142			SL045017-PP2NR	NNF 5017	249.8	430.6	51.4
90	140	67	66	59.2	137	4.2	0.6	1.5	54	54	51	109.3	118	152			SL045018-PP2NR	NNF 5018	316.8	535.6	62.6
95	145	67	66	59.2	142	4.2	0.6	1.5	54	54	51	113.35	122	157			SL045019-PP2NR	NNF 5019	324.6	560.2	64.7
100	150	67	66	59.2	147	4.2	0.6	1.5	54	54	51	117.35	128	162			SL045020-PP2NR	NNF 5020	322.7	563.2	64.2
110	170	80	79	70.2	167	4.2	0.6	1.8	64	65	62	131.55	143	182			SL045022-PP2NR	NNF 5022	406.0	683.2	75.3
120	180	80	79	71.2	176	4.2	0.6	1.8	64	65	63	140.9	153	196			SL045024-PP2NR	NNF 5024	428.3	749.5	80.9
130	200	95	94	83.2	196	4.2	0.6	1.8	77	77	75	156.75	170	216			SL045026-PP2NR	NNF 5026	565.6	1 023.2	107.4
	190	80	79	71.2	186	4.2	0.6	1.8	64	65	63	150.55	160	206			SL04130-PP	NNF130-PP	351.9	718.9	76.1
140	210	95	94	83.2	206	5.2	0.6	1.8	77	77	73	165.4	181	226			SL045028-PP2NR	NNF 5028	593.6	1 110.1	114.5
	200	80	79	71.2	196	4.2	0.6	1.8	64	65	63	159.95	170	216			SL04140-PP	NNF140-PP	365.0	770.8	80.2
150	225	100	99	87.2	221	5.2	0.6	2.0	80	81	77	175.7	192	245			SL045030-PP2NR	NNF 5030	679.3	1 304.0	131.7
	210	80	79	71.2	206	5.2	0.6	1.8	64	65	61	174.4	185	226			SL04150-PP	NNF150-PP	452.5	938.0	95.9
160	240	109	108	95.2	236	5.2	0.6	2.0	89	89	85	189	207	260			SL045032-PP2NR	NNF 5032	764.4	1 503.1	148.9
	220	80	79	71.2	216	5.2	0.6	1.8	64	65	61	184.05	196	236			SL04160-PP	NNF160-PP	464.4	940.8	94.6
170	260	122	121	107.2	254	5.2	0.6	2.0	100	99	97	200.7	220	282			SL045034-PP2NR	NNF 5034	935.2	1 807.2	175.2
	230	80	79	71.2	226	5.2	0.6	1.8	64	65	61	193.9	206	250			SL04170-PP	NNF170-PP	496.0	960.6	95.2
180	280	136	135	118.2	274	5.2	0.6	2.0	112	110	108	217.8	239	302			SL045036-PP2NR	NNF 5036	1 117.7	2 077.5	197.3
	240	80	79	71.2	236	5.2	0.6	1.8	64	65	61	203.1	216	260			SL04180-PP	NNF180-PP	607.4	1 220.2	119.1
190	290	136	135	118.2	284	5.2	0.6	2.0	112	110	108	225.65	248	312			SL045038-PP2NR	NNF 5038	1 189.9	2 286.2	214.4
	260	80	79	73.2	254	5.2	0.6	1.8	64	65	63	217.55	231	282			SL04190-PP	NNF190-PP	646.5	1 304.7	124.8
200	310	150	149	128.2	304	6.3	0.6	2.0	126	120	116	243.05	267	336			SL045040-PP2NR	NNF 5040	1 322.3	2 543.7	234.3
	270	80	79	73.2	264	5.2	0.6	1.8	64	65	63	227.15	241	292			SL04200-PP	NNF200-PP	692.7	1 396.1	131.8
220	340	160	159	138.2	334	6.3	1.0	2.0	132	130	126	259.85	286	366			SL045044-PP2NR	NNF 5044	1 634.6	3 154.4	282.5
	300	95	94	83.2	294	5.2	1.0	2.0	72	75	73	248.7	264	322			SL04220-PP	NNF220-PP	750.5	1 592.1	145.8

Double-row full-complement cylindrical roller bearings type NNF50.. (SL04..)

d = 240 - 300 mm

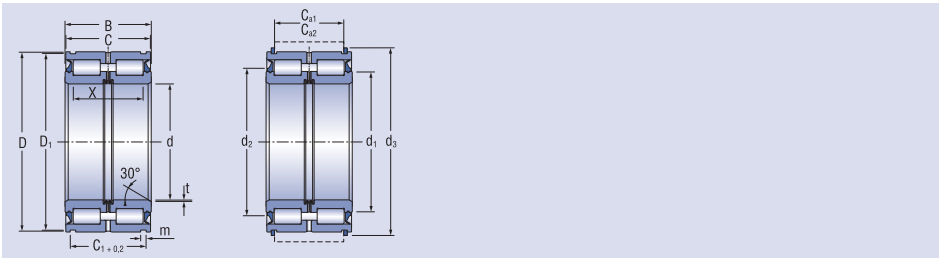

Dimensions														Bearing designation		Basic load rating		Fatigue load limit			
d	D	B	C	C ₁	D ₁	m	r _{smin}	t	x	C _{a1} ¹⁾	C _{a2} ²⁾	d ₁	d ₂	d ₃			C _r	C _{0r}	C _u		
mm																	kN				
240	360	160	159	138.2	354	6.3	1.0	2.0	132	130	126	279.25	305	386			SL045048-PP2NR	NNF 5048	1628.7	3355.9	294.3
	320	95	94	83.2	314	6.3	1.0	2.0	72	75	71	271.7	287	346			SL04240-PP	NNF240-PP	803.2	1722.5	154.2
260	400	190	189	162.2	394	6.3	1.1	3.0	150	154	150	304.95	336	426			SL045052-PP2NR	NNF 5052	2081.6	4202.3	358.2
	340	95	94	83.2	334	6.3	1.0	3.0	75	75	71	292.7	310	366			SL04260-PP	NNF260-PP	791.3	1732.3	151.9
280	420	190	189	163.2	413	7.3	1.1	3.0	150	154	149	320.95	354	453			SL045056-PP2NR	NNF 5056	2180.3	4547.1	380.8
300	460	218	216	185.2	453	7.3	1.1	3.0	170	176	171	346.85	375	493			SL045060-PP2NR	NNF 5060	2772.2	5731.2	468.3
	380	95	94	83.2	374	6.3	1.0	3.0	75	75	71	328	346	406			SL04300-PP	NNF300-PP	973.2	2367.0	200.0



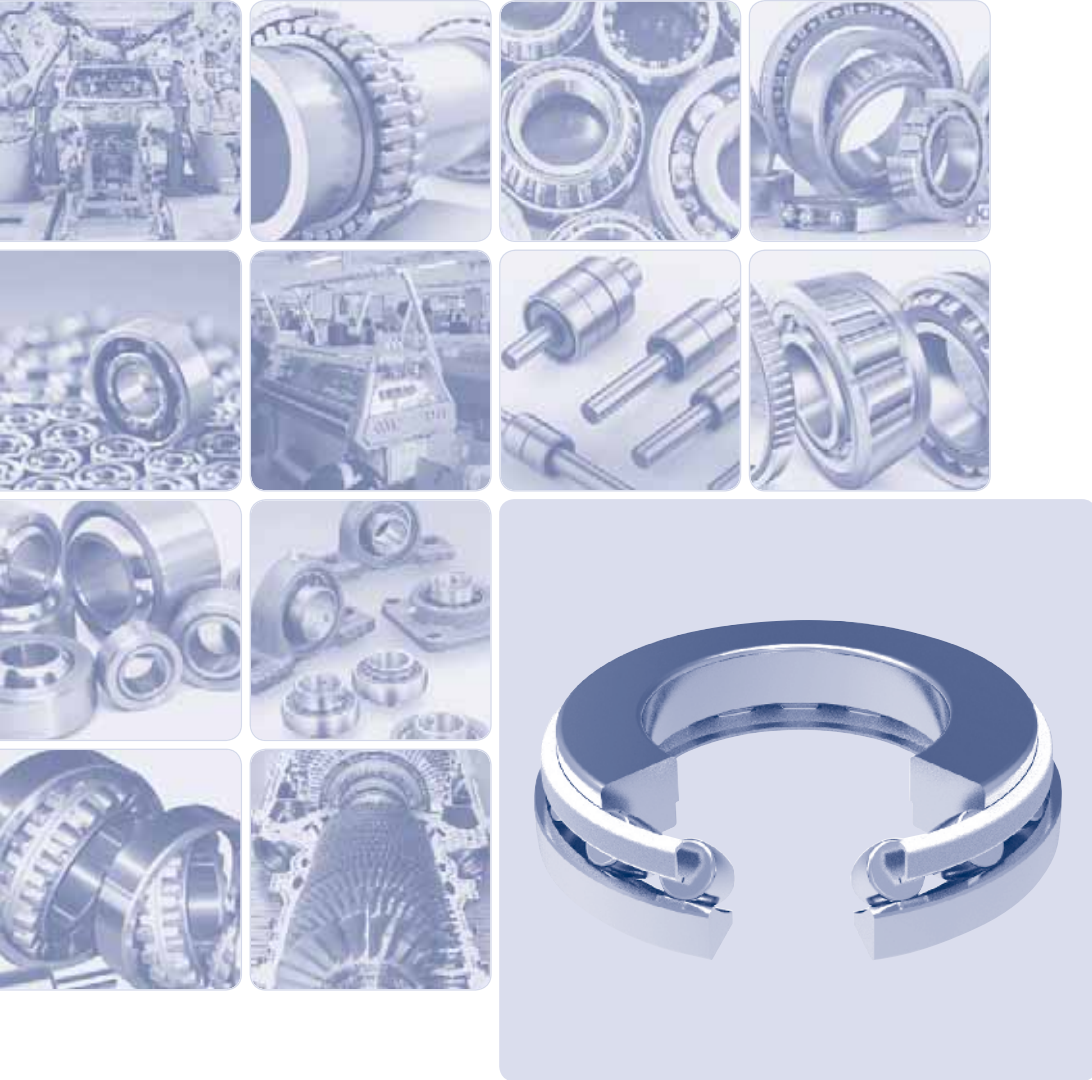

Spherical roller thrust bearings

Spherical roller thrust bearings

Spherical roller thrust bearings

Spherical roller thrust bearings have a large number of asymmetrical rollers with good fit to the raceways of the shaft washer and housing ring. They are suitable for accommodating large loads at relatively high speeds. In addition to high axial loads, these bearings can also accommodate certain radial forces. The spherical raceway of the housing ring can compensate misalignments between the shaft and the housing. Spherical roller thrust bearings are dismountable, which allows separate mounting of shaft units (shaft washers with a cage and rolling elements) and housing rings.

Due to the internal structure of these bearings, oil lubrication is necessary, except for operation at very low speeds.

Boundary Dimensions

The boundary dimensions of spherical roller thrust bearings given in the dimension tables comply with the ISO 104 international dimension plan.

Designation

The designation of bearings with the basic design is given in the dimension tables. The difference from the basic design is designated by additional marks.

Cages

Spherical roller thrust bearings have brass cages, guided using a steel sleeve on a shaft washer (designation M), or have brass cages, guided on a shaft washer.

The J design spherical roller thrust bearings have a sheet steel cage guided on a shaft washer. Spherical roller thrust bearings with a sheet steel cage (J) are interchangeable with bearings with a solid brass cage. If a spherical roller thrust bearing with a brass cage, arranged so that the shaft washer rests on the shaft against the face of the steel sleeve that guides the cage, is to be replaced by the J design bearing, a spacer needs to be inserted between the shaft washer and the original shaft mounting, as shown in the picture.

Precision

Spherical roller thrust bearings are normally manufactured with normal precision grade P0 (the P0 mark is not designated). The manufacturing of bearings with a higher precision grade needs to be discussed in advance.

Permissible Misalignment

The spherical raceway of the housing ring of spherical roller thrust bearings allows, under normal operating conditions ($P_a \leq 0.1 C_a$), a misalignment from the centre without disrupting the correct function of the bearing by the values given in the table.

Bearing Type	Permissible Misalignment
292	2°
293	2°30'
294	3°

Arrangement Structure

The connection dimensions given in the dimension tables are suitable for bearings where the load $P_a \leq 0.1 C_a$. At higher loads, it is appropriate to support the bearing rings across the entire end face, i.e. $d_a = d_1$ and $D_a = D_1$.

Axial Equivalent Dynamic and Static Load

Axial Equivalent Dynamic Load

Depending on the effect of wobbling of the bearing arrangement and its elimination by mutual movement of rings and in compliance with the condition $F_r \leq 0.55.F_a$, the following applies:

$$P_a = F_a + 1.2.F_r \quad \text{- if the wobbling affects the load distribution in the bearing}$$

$$P_a = 0.88.(F_a + 1.2.F_r) \quad \text{- if the wobbling does not affect the load distribution in the bearing}$$

Where:

$$P_a \text{ - equivalent dynamic bearing load (N)}$$

$$F_a \text{ - axial load (N)}$$

$$F_r \text{ - radial load (N)}$$

If $F_r > 0.55.F_a$, the calculation of the arrangement should be consulted with R&D KINEX.

Axial Equivalent Static Load

For axial load, provided that $F_r \leq 0.55.F_a$, the following applies:

$$P_{0a} = F_a + 2.7.F_r$$

Where:

$$P_{0a} \text{ - equivalent static bearing load (N)}$$

$$F_a \text{ - axial load (N)}$$

$$F_r \text{ - radial load (N)}$$

If $F_r > 0.55.F_a$, the calculation of the arrangement should be consulted with R&D KINEX.

Minimum Axial Load

The operation of spherical roller thrust bearings poses a risk of the rolling elements slipping between the raceways of the rings due to centrifugal forces and friction in the lubricant and consequent damage to the rolling elements or raceways. As a result, a certain minimum load must be applied to the bearing. The minimum load will be calculated with sufficient accuracy using the following formula:

$$F_{amin} = 0.00125.C_{0a}$$

Where:

$$F_{amin} \text{ - minimum load}$$

$$C_{0a} \text{ - static load capacity}$$

Spherical roller thrust bearings

d = 60 - 160 mm

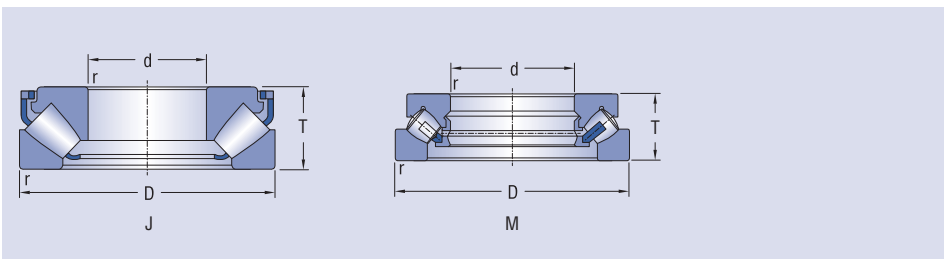

Dimensions				Bearing designation	Basic load rating		Fatigue load limit	Limiting speed for lubrication with oil	Mass of Bearings
d	D	T	r _s min		dynamic	static			
mm					C _r	C _{0r}	C _u	min ⁻¹	kg
60	130	42	1.5	29412J	345	915	115	2 600	2.52
	130	42	1.5	29412M	290	925	112	2 400	2.80
65	140	45	2	29413J	460	1 080	130	2 400	3.10
	140	45	2	29413M	340	1 080	130	2 200	3.75
70	150	48	2	29414J	450	1 240	148	2 200	3.83
	150	48	2	29414M	380	1 230	145	2 000	4.31
75	160	51	2	29415J	525	1 430	166	2 200	4.61
	160	51	2	29415M	440	1 270	147	2 000	4.72
80	170	54	2.1	29416J	575	1 630	186	2 000	5.50
	170	54	2.1	29416M	468	1 380	157	1 900	6.09
85	180	58	2.1	29417J	645	1 760	201	1 900	6.61
	180	58	2.1	29417M	510	1 658	185	1 800	7.05
90	190	60	2.1	29418J	695	1 950	220	1 800	7.65
	190	60	2.1	29418M	560	1 980	218	1 700	8.01
100	170	42	1.5	29320J	410	1 280	262	2 000	3.57
	210	67	3	29420J	840	2 400	267	1 700	10.6
	210	67	3	29420M	760	2 500	267	1 600	14.2
110	190	48	2	29322J	530	1 710	186	1 600	5.24
	190	48	2	29322M	455	1 646	177	1 600	7.03
	230	73	3	29422J	1 010	2 930	312	1 400	13.40
	230	73	3	29422M	905	2 610	271	1 400	17.90
120	210	54	2.1	29324J	645	2 100	222	1 600	7.33
	210	54	2.1	29324M	545	2 100	220	1 400	7.92
	250	78	4	29424J	1 170	3 450	410	1 300	16.20
	250	78	4	29424M	960	3 300	355	1 300	18.80
130	225	58	2.1	29326J	753	2 500	256	1 500	8.85
	225	58	2.1	29326M	600	2 260	232	1 300	9.65
	270	85	4	29426J	1 380	4 050	401	1 200	22.1
	270	85	4	29426M	1 110	3 500	346	1 200	29.2
140	240	60	2.1	29328J	845	2 850	286	1 400	10.30
	240	60	2.1	29328M	707	2 490	250	1 300	11.20
	280	85	4	29428J	1 400	4 300	419	1 200	22.40
	280	85	4	29428M	1 160	4 200	410	1 200	25.50
150	250	60	2.1	29330J	870	2 900	287	1 400	10.90
	250	60	2.1	29330M	715	2 500	247	1 200	11.50
	300	90	4	29430J	1 530	4 900	468	1 100	27.70
	300	90	4	29430M	1 310	4 750	454	1 100	30.40
160	270	67	3	29332J	1 000	3 400	329	1 200	14.30
	270	67	3	29332M	840	3 330	322	1 100	15.80
	320	95	5	29432J	1 790	5 450	511	1 000	32.60
	320	95	5	29432M	1 450	4 850	454	1 000	35.10

Spherical roller thrust bearings

d = 170 - 360 mm

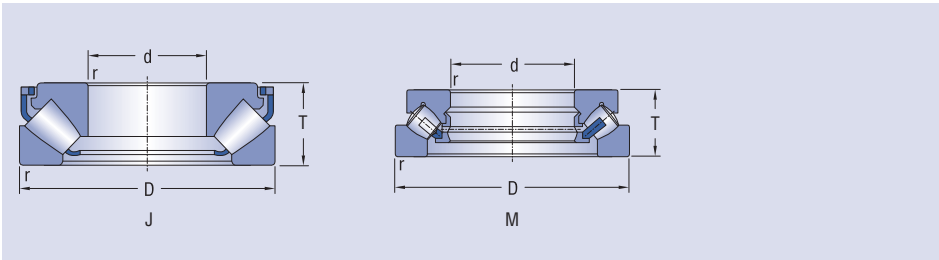

Dimensions				Bearing designation	Basic load rating		Fatigue load limit	Limiting speed for lubrication with oil	Mass of Bearings
d	D	T	r _s min		dynamic	static			
mm					C _r	C _{0r}	C _u	min ⁻¹	kg
170	280	67	3	29334J	1 100	3 500	334	1 200	14.80
	280	67	3	29334M	850	3 400	325	1 100	16.50
	340	103	5	29434J	2 360	6 550	603	950	40.00
	340	103	5	29434M	1 658	5 330	490	950	40.80
180	300	73	3	29336J	1 430	4 300	403	1 100	19.10
	300	73	3	29336M	1 000	4 050	380	1 000	21.70
	360	109	5	29436J	2 600	7 350	665	950	47.40
	360	109	5	29436M	1 870	6 110	553	900	62.20
190	320	78	4	29338J	1 630	4 750	437	1 100	22.90
	320	78	4	29338M	1 180	4 950	455	950	26.00
	380	115	5	29438J	2 850	8 000	712	850	56.00
	380	115	5	29438M	2 230	7 690	685	850	61.40
200	280	48	2	29240M	536	2 270	212	1 150	8.90
	340	85	4	29340J	1 860	5 500	497	950	28.60
	340	85	4	29340M	1 140	4 750	430	900	33.00
	400	122	5	29440J	2 760	9 000	789	800	65.80
	400	122	5	29440M	2 460	8 470	742	800	73.00
220	300	48	2	29244M	542	2 490	228	1 050	10.00
	360	85	4	29344M	1 380	5 240	264	900	34.00
	420	122	6	29444M	2 540	8 990	773	750	74.90
240	340	60	2.1	29248M	822	3 680	326	900	16.70
	380	85	4	29348M	1 410	5 500	477	800	35.50
	440	122	6	29448M	2 610	9 500	802	750	83.00
260	360	60	2.1	29252M	838	3 720	323	900	18.50
	420	95	5	29352M	1 810	6 950	587	750	51.50
	480	132	6	29452M	3 100	11 100	914	670	110.0
280	380	60	2.1	29256M	862	4 020	342	850	19.50
	440	95	5	29356M	1 840	7 150	593	710	53.20
	520	145	6	29456M	3 650	13 600	1 094	660	137.0
300	420	73	3	29260M	1 060	4 880	405	750	30.50
	480	109	5	29360M	2 250	8 790	712	630	70.00
	540	145	6	29460M	3 880	14 900	1 181	620	146.0
320	440	73	3	29264M	1 430	6 480	529	750	32.70
	500	109	5	29364M	2 310	9 380	749	680	74.90
	580	155	7.5	29464M	4 160	16 100	1 250	560	179.0
340	460	73	3	29268M	1 390	6 420	516	700	33.0
	540	122	5	29368M	2 700	11 000	860	620	106.0
	620	170	7.5	29468M	4 960	19 400	1 477	500	224.0
360	500	85	4	29272M	1 460	6 800	535	650	51.80
	560	122	5	29372M	2 780	11 600	895	600	109.0
	640	170	6	29472M	5 380	21 200	1 595	500	230.0

Spherical roller thrust bearings

d = 380 - 400 mm

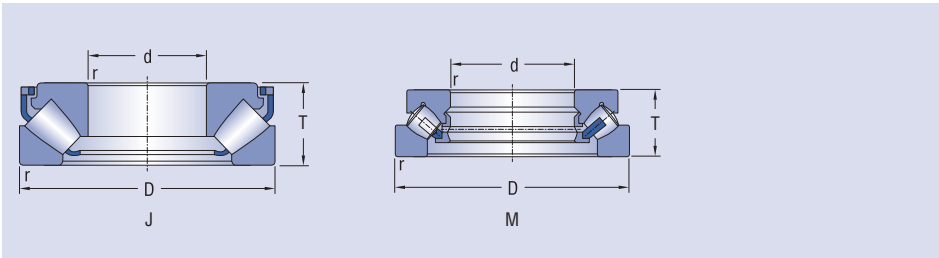

Dimensions				Bearing designation	Basic load rating		Fatigue load limit	Limiting speed for lubrication with oil	Mass of Bearings
d	D	T	r _s min		dynamic	static			
mm						C _r	C _{0r}	C _u	
380	520	85	4	29276M	1580	7 690	597	600	53.00
	600	132	6	29376M	3340	14 000	1 060	560	140.0
	670	175	7.5	29476M	5870	24 000	1 780	470	260.0
400	540	85	4	29280M	1650	8 000	613	600	55.50
	620	132	6	29380M	3450	14 600	1 092	560	150.0
	710	185	7.5	29480M	6560	26 500	1 932	470	310.0





Cylindrical roller thrust bearings

Cylindrical roller thrust bearings

Cylindrical roller thrust bearings Cylindrical roller thrust bearings consist of cylindrical rollers and cage thrust assemblies and two bearing washers. The design can be single-row or double-row. They are rigid, have high load capacity and are resistant to impact loads. They can only accommodate axial forces.

Boundary Dimensions The boundary dimensions of cylindrical roller thrust bearings given in the dimension tables comply with the ISO 104 international dimension plan.

Design The components of cylindrical roller thrust bearings allow a combination of a cage with rollers and raceways formed by individual machine parts, or a combination of one raceway formed by a machine part and a bearing ring. A separate cage with rollers has the additional designation K, a separate shaft washer is designated WS and a separate housing ring is designated GS.

Designation The designation of bearings with the basic design is given in the dimension tables. The difference from the basic design is designated by additional marks.

Cages Cylindrical roller thrust bearings cages are made of polyamide 66 (designation TN) or brass (designation M).

Precision Cylindrical roller thrust bearings are normally manufactured with normal precision grade P0 (the P0 mark is not designated). Bearings with higher precision grades P6 and P5 are available for special arrangements that require higher precision. Limiting values for dimensional and running accuracy deviations are given in ISO 199.

Minimum Axial Load Cylindrical roller thrust bearings must be subjected to a certain minimum load to ensure reliable bearing function. If this load is not observed, abnormal rolling and slipping of the rolling elements and consequent damage to the raceways may occur.

The minimum load is calculated as follows:

$$F_{a \min} = \left(\frac{C_{0a}}{2000} \right) + M \cdot \left(\frac{n}{1000} \right)^2$$

Where

$F_{a \min}$ - minimum axial load [kN]

C_{0a} - static load capacity [kN]

n - speed [min^{-1}]

M - coefficient of minimum axial load

(The values are given in the dimension tables.)

Unless the minimum load is caused naturally in the bearing arrangement, the bearing must be loaded with additional force by a shaft nut or springs.

Axial Equivalent Dynamic and Static Load

Axial Equivalent Dynamic Load

$$P_a = F_a$$

Axial Equivalent Static Load

$$P_{0a} = F_a$$

Cylindrical roller thrust bearings

d = 15 - 75 mm

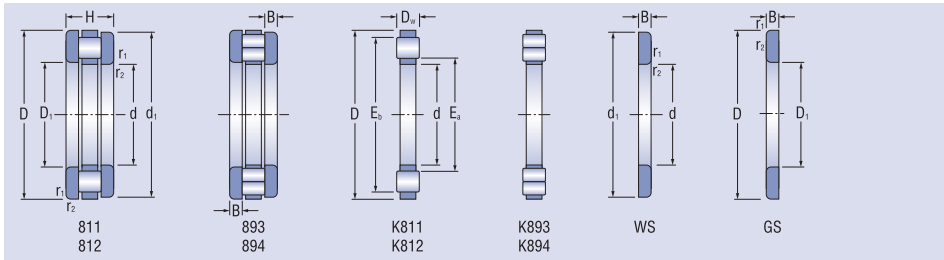

Dimensions										Bearing designation	Basic load rating		Fatigue load limit	Limiting speed for lubrication with grease oil		Mass of Bearings	Bearing component designation			
d	D ₁	D	d ₁	H	D _w	B	r _{smin}	E _b	E _a		C _r	C _{0r}		C _u				kg	Cage with rollers	Shaft ring
mm											kN			min ⁻¹						
15	16	28	28	9	3.5	2.75	0.3	16	27	81102TN	11.7	24.0	2.9	0.0006	13 600	6 300	0.024	K81102TN	WS 81102	GS 81102
17	18	30	30	9	3.5	2.75	0.3	18	29	81103TN	12.9	28.4	3.4	0.0008	12 400	5 400	0.027	K81103TN	WS 81103	GS 81103
20	21	35	35	10	4.5	2.75	0.3	21	34	81104TN	18.7	39.8	4.8	0.0019	10 500	4 300	0.037	K81104TN	WS 81104	GS 81104
25	26	42	42	11	5	3	0.6	26	41	81105TN	25.2	59.0	7.2	0.0004	8 600	3 500	0.053	K81105TN	WS 81105	GS 81105
30	32	47	47	11	5	3	0.6	31	46	81106TN	26.8	68.3	8.3	0.0005	7 500	3 050	0.057	K81106TN	WS 81106	GS 81106
	32	52	52	16	7.5	4.25	0.6	31	50	81206TN	49.5	108.4	13.2	0.0014	7 100	2 650	0.123	K81206TN	WS 81206	GS 81206
	32	60	60	18	5.5	6.25	1	33	59	89306TN	52.4	159.7	19.5	0.003	6 400	2 600	0.240	K89306TN	WS 89306	GS 89306
35	37	52	52	12	5	3.5	0.6	36	51	81107TN	29.4	81.8	10.0	0.0007	6 600	2 600	0.073	K81107TN	WS 81107	GS 81107
	37	62	62	18	7.5	5.25	1	39	58	81207TN	50.7	121.5	14.8	0.003	5 900	2 320	0.195	K81207TN	WS 81207	GS 81207
	37	68	68	20	6	7	1	38	67	89307TN	61.5	194.0	23.6	0.004	5 600	2 390	0.340	K89307TN	WS 89307	GS 89307
40	42	60	60	13	6	3.5	0.6	42	58	81108TN	42.7	120.8	14.7	0.0016	5 800	2 190	0.105	K81108TN	WS 81108	GS 81108
	42	68	68	19	9	5	1	43	66	81208TN	84.1	211.2	25.7	0.0053	5 200	1 860	0.249	K81208TN	WS 81208	GS 81208
	42	78	78	22	7	7.5	1	44	77	89308TN	79.6	252.4	30.8	0.011	4 800	1 780	0.484	K89308TN	WS 89308	GS 89308
45	47	65	65	14	6	4	0.6	47	63	81109TN	44.9	134.5	16.4	0.002	5 300	1 970	0.130	K81109TN	WS 81109	GS 81109
	47	73	73	20	9	5.5	1	48	70	81209TN	82.4	214.8	26.2	0.0059	4 850	1 820	0.287	K81209TN	WS 81209	GS 81209
	47	85	85	24	7.5	8.25	1	49	83	89309TN	107.9	371.6	45.3	0.015	4 400	1 620	0.615	K89309TN	WS 89309	GS 89309
50	52	70	70	14	6	4	0.6	52	68	81110TN	47.0	148.3	18.8	0.0023	4 800	1 810	0.140	K81110TN	WS 81110	GS 81110
	52	78	78	22	9	6.5	1	53	75	81210TN	81.0	217.8	26.5	0.0072	4 450	1 550	0.356	K81210TN	WS 81210	GS 81210
	52	95	95	27	8	9.5	1.1	56	92	89310TN	130.8	473.5	57.7	0.023	3 950	1 460	0.887	K89310TN	WS 89310	GS 89310
55	57	78	78	16	6	5	0.6	57	77	81111TN	70.0	259.4	31.6	0.0068	4 300	1 330	0.218	K81111TN	WS 81111	GS 81111
	57	90	90	25	11	7	1	59	85	81211TN	110.0	287.4	35.0	0.013	4 000	1 510	0.568	K81211TN	WS 81211	GS 81211
	57	105	105	30	9	10.5	1.1	61	103	89311TN	151.1	537.7	65.6	0.026	3 600	1 490	1.180	K89311TN	WS 89311	GS 89311
60	62	85	85	17	7.5	4.75	1	62	82	81112TN	80.1	267.6	32.6	0.0075	4 000	1 360	0.266	K81112TN	WS 81112	GS 81112
	62	95	95	26	11	7.5	1	64	91	81212TN	136.2	394.5	48.1	0.018	3 700	1 300	0.642	K81212TN	WS 81212	GS 81212
	62	110	110	30	9	10.5	1.1	66	108	89312TN	154.0	566.5	69.1	0.033	3 350	1 350	1.260	K89312TN	WS 89312	GS 89312
	62	130	130	42	14	14	1.5	65	126	89412TN	309.3	1008.4	123.0	0.111	3 000	1 080	2.818	K89412TN	WS 89412	GS 89412
65	67	90	90	18	7.5	5.25	1	67	87	81113TN	83.4	289.6	35.3	0.0083	3 700	1 260	0.310	K81113TN	WS 81113	GS 81113
	67	100	100	27	11	8	1	69	96	81213TN	139.4	419.5	51.1	0.020	3 450	1 240	0.721	K81213TN	WS 81213	GS 81213
	67	115	115	30	9	10.5	1.1	71	113	89313TN	152.1	570.2	69.5	0.033	3 200	1 330	1.330	K89313TN	WS 89313	GS 89313
	68	140	140	45	15	15	2	70	135	89413TN	352.6	1166.3	141.2	0.150	2 800	1 000	3.520	K89413TN	WS 89413	GS 89413
70	72	95	95	18	7.5	5.25	1	72	92	81114TN	86.4	311.6	38.0	0.0096	3 500	1 170	0.33	K81114TN	WS 81114	GS 81114
	72	105	105	27	11	8	1	74	102	81214TN	148.0	465.5	56.7	0.023	3 250	1 130	0.77	K81214TN	WS 81214	GS 81214
	72	125	125	34	10	12	1.1	76	123	89314TN	99.9	315.9	38.5	0.050	2 950	1 200	1.82	K89314TN	WS 89314	GS 89314
	73	150	150	48	16	16	2	76	147	89414TN	378.5	1246.5	147.7	0.171	2 650	1 000	4.18	K89414TN	WS 89414	GS 89414
75	77	100	100	19	7.5	5.75	1	78	97	81115TN	83.3	303.2	37.0	0.009	3 300	1 190	0.40	K81115TN	WS 81115	GS 81115
	77	110	110	27	11	8	1	79	106	81215TN	135.8	426.4	52.0	0.019	3 100	1 210	0.80	K81215TN	WS 81215	GS 81215
	77	135	135	36	11	12.5	1.5	81	132	89315TN	226.8	866.6	104.1	0.075	2 750	1 080	2.23	K89315TN	WS 89315	GS 89315
	78	160	160	51	17	17	2	82	153	89415M	398.1	1297.5	150.7	0.187	2 400	1 000	5.96	K89415M	WS 89415	GS 89415

Cylindrical roller thrust bearings

d = 80 - 160 mm

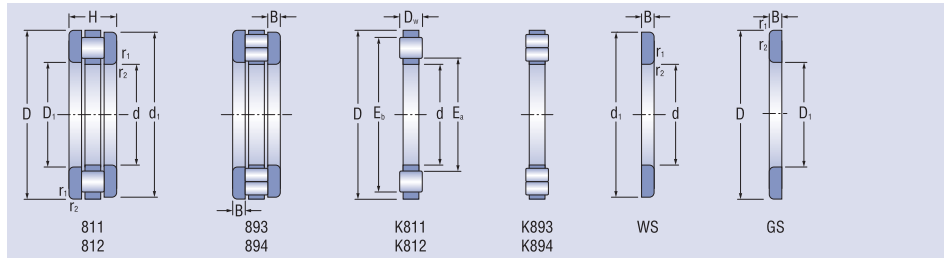

Dimensions										Bearing designation	Basic load rating		Fatigue load limit	Limiting speed for lubrication with grease oil		Mass of Bearings	Bearing component designation			
d	D ₁	D	d ₁	H	D _w	B	r _{smin}	E _b	E _a		C _r	C _{0r}		C _u				kg	Cage with rollers	Shaft ring
mm											kN			min ⁻¹						
80	82	105	105	19	7.5	5.75	1	83	102	81116TN	82.2	304.8	37.1	0.009	3 100	1 170	0.40	K81116TN	WS 81116	GS 81116
	82	115	115	28	11	8.5	1	84	112	81216TN	158.7	536.7	65.4	0.029	2 900	990	0.90	K81216TN	WS 81216	GS 81216
	82	140	140	36	11	12.5	1.5	86	137	89316M	241.0	958.3	113.6	0.090	2 600	990	2.37	K89316M	WS 89316	GS 89316
	83	170	170	54	18	18	2.1	88	165	89416M	443.6	1463.0	166.	0.239	2 260	950	7.40	K89416M	WS 89416	GS 89416
85	87	110	110	19	7.5	5.75	1	87	108	81117TN	87.3	336.8	41.0	0.012	2 950	1 070	0.42	K81117TN	WS 81117	GS 81117
	88	125	125	31	12	9.5	1	90	119	81217TN	170.9	565.9	68.0	0.025	2 750	1 060	1.26	K81217TN	WS 81217	GS 81217
	88	150	150	39	12	13.5	1.5	93	147	89317M	256.5	990.8	115.1	0.097	2 400	1 030	3.39	K89317M	WS89317	GS 89317
	88	180	180	58	19	19.5	2.1	93	175	89417M	491.2	1 638.5	183.6	0.298	2 130	900	8.65	K89417M	WS 89417	GS 89417
90	92	120	120	22	9	6.5	1	93	117	81118TN	110.4	405.5	48.7	0.014	2 750	1 070	0.62	K81118TN	WS 81118	GS 81118
	93	135	135	35	14	10.5	1.1	95	129	81218TN	231.5	759.4	89.4	0.061	2 550	910	1.77	K81218TN	WS 81218	GS 81218
	93	155	155	39	12	13.5	1.5	98	152	89318M	264.1	1 047.8	120.2	0.108	2 310	980	3.63	K89318M	WS 89318	GS 89318
	93	190	190	60	20	20	2.1	99	185	89418M	541.8	1 823.9	201.0	0.360	2 010	850	9.94	K89418M	WS 89418	GS 89418
100	102	135	135	25	11	7	1	104	131	81120TN	157.2	570.3	66.2	0.028	2 460	920	0.95	K81120TN	WS 81120	GS 81120
	103	150	150	38	15	11.5	1.1	107	142	81220TN	271.4	921.7	105.1	0.056	2 300	840	2.20	K81220TN	WS 81220	GS 81220
	103	170	170	42	13	14.5	1.5	107	167	89320M	302.6	1 219.9	135.9	0.150	2 090	910	4.56	K89320M	WS 89320	GS 89320
	103	210	210	67	22	22.5	3	111	205	89420M	680.7	2 372.2	253.6	0.627	1 810	720	13.4	K89420M	WS 89420	GS 89420
110	112	145	145	25	11	7	1	114	141	81122TN	162.9	619.1	70.2	0.031	2 260	850	1.40	K81122TN	WS 81122	GS 81122
	113	160	160	38	15	11.5	1.1	117	152	81222TN	257.4	890.6	99.2	0.068	2 130	860	2.29	K81222TN	WS 81222	GS 81222
	113	190	190	48	15	16.5	2	120	186	89322M	402.2	1 639.5	177.0	0.270	1 890	790	6.70	K89322M	WS 89322	GS 89322
	113	230	30	73	24	24.5	3	121	223	89422M	802.5	2 844.1	295.8	0.898	1 660	640	17.4	K89422M	WS 89422	GS 89422
120	122	155	155	25	11	7	1	124	151	81124TN	168.8	667.9	74.0	0.038	2 100	780	1.12	K81124TN	WS 81124	GS 81124
	123	170	170	39	15	12	1.1	127	162	81224TN	253.6	898.2	98.0	0.076	1 990	790	2.54	K81224TN	WS 81224	GS 81224
	123	210	210	54	17	18.5	2.1	130	206	89324M	509.3	2 093.3	219.7	0.450	1 710	690	9.44	K89324M	WS 89324	GS 89324
	123	250	250	78	26	26	4	133	243	89424M	934.7	3 358.7	340.5	1.217	1 520	580	21.9	K89424M	WS 89424	GS 89424
130	132	170	170	30	12	9	1	135	165	81126TN	199.6	801.5	86.5	0.049	1 930	760	1.67	K81126TN	WS 81126	GS 81126
	133	190	187	45	19	13	1.5	137	181	81226TN	379.1	1 296.6	137.3	0.170	1 800	710	3.98	K81226TN	WS 81226	GS 81226
	134	225	225	58	18	20	2.1	141	220	89326M	566.1	2 362.8	242.5	0.562	1 590	650	11.2	K89326M	WS 89326	GS 89326
	134	270	270	85	28	28.5	4	145	263	89426M	1 061.7	3 856.7	382.0	1.620	1 400	530	27.1	K89426M	WS 89426	GS 89426
140	142	180	178	31	12	9.5	1	145	175	81128TN	186.8	752.1	79.6	0.059	1 800	710	1.90	K81128TN	WS 81128	GS 81128
	143	200	197	46	19	13.5	1.5	147	191	81228M	360.0	1 241.6	129.1	0.162	1 700	730	5.70	K81228M	WS 81228	GS 81228
	144	240	240	60	19	20.5	2.1	152	235	89328M	649.8	2 780.9	279.7	0.769	1 490	570	13.2	K89328M	WS 89328	GS 89328
	144	280	280	85	28	28.5	4	155	273	89428M	1 105.1	4 164.2	406.5	1.843	1 340	490	29.8	K89428M	WS 89428	GS 89428
150	152	190	188	31	12	9.5	1	155	185	81130TN	213.6	917.7	95.4	0.067	1 700	660	2.20	K81130TN	WS 81130	GS 81130
	153	215	212	50	21	14.5	1.5	158	211	81230M	468.7	1 665.6	169.6	0.300	1 540	650	7.17	K81230M	WS 81230	GS 81230
	154	250	250	60	19	20.5	2.1	162	245	89330M	665.2	2 929.5	290.2	0.845	1 410	510	13.9	K89330M	WS 89330	GS 89330
	154	300	300	90	30	30	4	167	293	89430M	1 260.7	4 804.8	459.4	2.509	1 240	445	35.4	K89430M	WS 89430	GS 89430
160	162	200	198	31	12	9.5	1	165	195	81132TN	215.5	948.6	97.0	0.085	1 600	670	2.12	K81132TN	WS 81132	GS 81132
	163	225	222	51	21	15	1.5	168	220	81232M	480.5	1 756.7	176.0	0.330	1 470	610	7.60	K81232M	WS 81232	GS 81232
	164	320	320	95	32	31.5	5	179	313	89432M	1 425.7	5 491.2	515.0	3.300	1 160	410	42.0	K89432M	WS 89432	GS 89432

Cylindrical roller thrust bearings

d = 170 - 320 mm

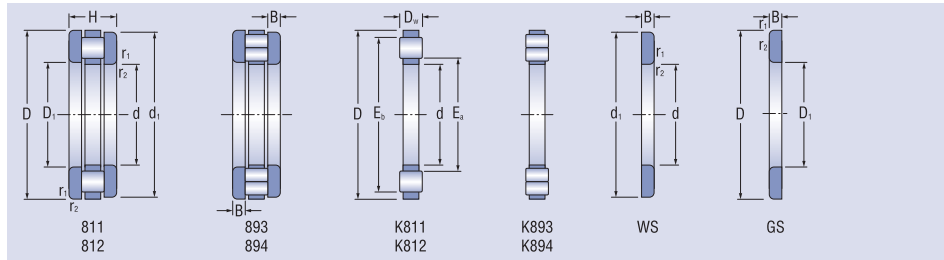

Dimensions										Bearing designation	Basic load rating		Fatigue load limit	Limiting speed for lubrication with		Mass of Bearings	Bearing component designation			
d	D ₁	D	d ₁	H	D _w	B	r _{smin}	E _b	E _a		d _r	C _{or}		C _u	grease		oil	kg	Cage with rollers	Shaft ring
mm											kN			min ⁻¹						
170	172	215	213	34	14	10	1.1	176	209	81134TN	285.2	1 242.9	124.5	0.110	1 500	570	2.41	K81134TN	WS 81134	GS 81134
	173	240	234	55	22	16.5	1.5	180	235	81234M	540.9	2 027.2	199.3	0.430	1 370	600	9.30	K81234M	WS 81234	GS 81234
	174	340	340	103	34	34.5	5	191	233	89434M	1 599.9	6 223.4	573.1	4.150	1 090	375	51.9	K89434M	WS 89434	GS 89434
180	183	225	222	34	14	10	1.1	185	219	81136M	266.5	1 174.3	115.9	0.130	1 420	590	3.30	K81136M	WS 81136	GS 81136
	183	250	247	56	22	17	1.5	190	245	81236M	552.5	2 127.2	206.2	0.470	1 310	580	9.90	K81236M	WS 81236	GS 81236
	184	184	360	109	36	36.5	5	200	351	89436M	1 767.0	6 918.9	626.3	5.100	1 040	360	60.0	K89436M	WS 89436	GS 89436
190	193	240	237	37	15	11	1.1	197	233	81138M	308.5	1 355.6	131.4	0.170	1 330	570	4.74	K81138M	WS 81138	GS 81138
	194	270	267	62	26	18	2	200	265	81238M	701.9	2 599.6	246.9	0.680	1 220	530	12.8	K81238M	WS 81238	GS 81238
	195	380	380	115	38	38.5	5	214	373	89438M	1 958.8	7 738.0	689.2	6.500	990	330	72.1	K89438M	WS 89438	GS 89438
200	203	250	247	37	15	11	1.1	206	243	81140M	312.6	1 402.6	134.1	0.190	1 270	530	4.95	K81140M	WS 81140	GS 81140
	204	280	277	62	26	18	2	210	275	81240M	720.8	2 737.9	256.7	0.790	1 170	485	14.2	K81240M	WS 81240	GS 81240
	205	400	400	122	40	41	5	226	393	89440M	2 159.7	8 602.9	754.6	8.000	940	315	82.6	K89440M	WS 89440	GS 89440
220	223	270	267	37	15	11	1.1	226	263	81144M	333.6	1 581.8	147.4	0.240	1 170	470	5.22	K81144M	WS 81144	GS 81144
	224	300	297	63	26	18.5	2	230	296	81244M	756.5	3 014.7	276.0	0.910	1 080	435	15.3	K81244M	WS 81244	GS 81244
	225	420	420	122	40	41	6	244	411	89444M	2 340.5	9 843.7	846.8	10.000	870	270	90.1	K89444M	WS 89444	GS 89444
240	243	300	297	45	18	13.5	1.5	248	296	81148M	478.3	2 270.1	205.5	0.500	1 050	440	8.45	K81148M	WS 81148	GS 81148
	244	340	335	78	32	23	2.1	261	335	81248M	1 098.7	4 321.6	382.9	1.900	960	395	26.2	K81248M	WS 81248	GS 81248
	245	440	440	122	40	41	6	266	433	89448M	2 407.4	10 510.3	887.9	12.000	830	250	95.9	K89448M	WS 89448	GS 89448
260	263	320	317	45	18	13.5	1.5	268	316	81152M	488.9	2 404.6	213.0	0.560	980	390	9.80	K81152M	WS 81152	GS 81152
	264	360	355	79	32	23.5	2.1	280	353	81252M	1 152.0	4 735.0	411.2	2.300	910	355	28.6	K81252M	WS 81252	GS 81252
	265	480	480	132	44	44	6	288	472	89452M	2 857.3	12 588.6	1 036.8	16.000	760	224	125.0	K89452M	WS 89452	GS 89452
280	283	350	347	53	22	15.5	4.5	288	346	81156M	689.1	3 306.3	285.7	1.100	900	345	12.6	K81156M	WS 81156	GS 81156
	284	380	375	80	32	24	2.1	300	373	81256M	1 170.9	4 958.7	422.6	2.400	850	335	31.0	K81256M	WS 81256	GS 81256
	285	520	520	145	48	48.5	6	311	512	89456M	3 377.4	13 194.7	1 061.6	19.000	700	199	159.0	K89456M	WS 89456	GS 89456
300	304	380	376	62	25	18.5	2	315	373	81160M	852.5	4 054.1	342.4	1.500	840	330	19.4	K81160M	WS 81160	GS 81160
	304	420	415	95	38	28.5	3	328	413	81260M	1 545.5	6 388.8	530.5	4.200	780	305	48.2	K81260M	WS 81260	GS 81260
	305	540	540	145	48	48.5	6	331	533	89460M	3 479.6	15 993.9	1 268.1	25.920	670	188	170.0	K89460M	WS 89460	GS 89460
320	324	400	396	63	25	19	2	334	394	81164M	876.8	4 311.5	358.0	1.900	790	290	20.7	K81164M	WS 81164	GS 81164



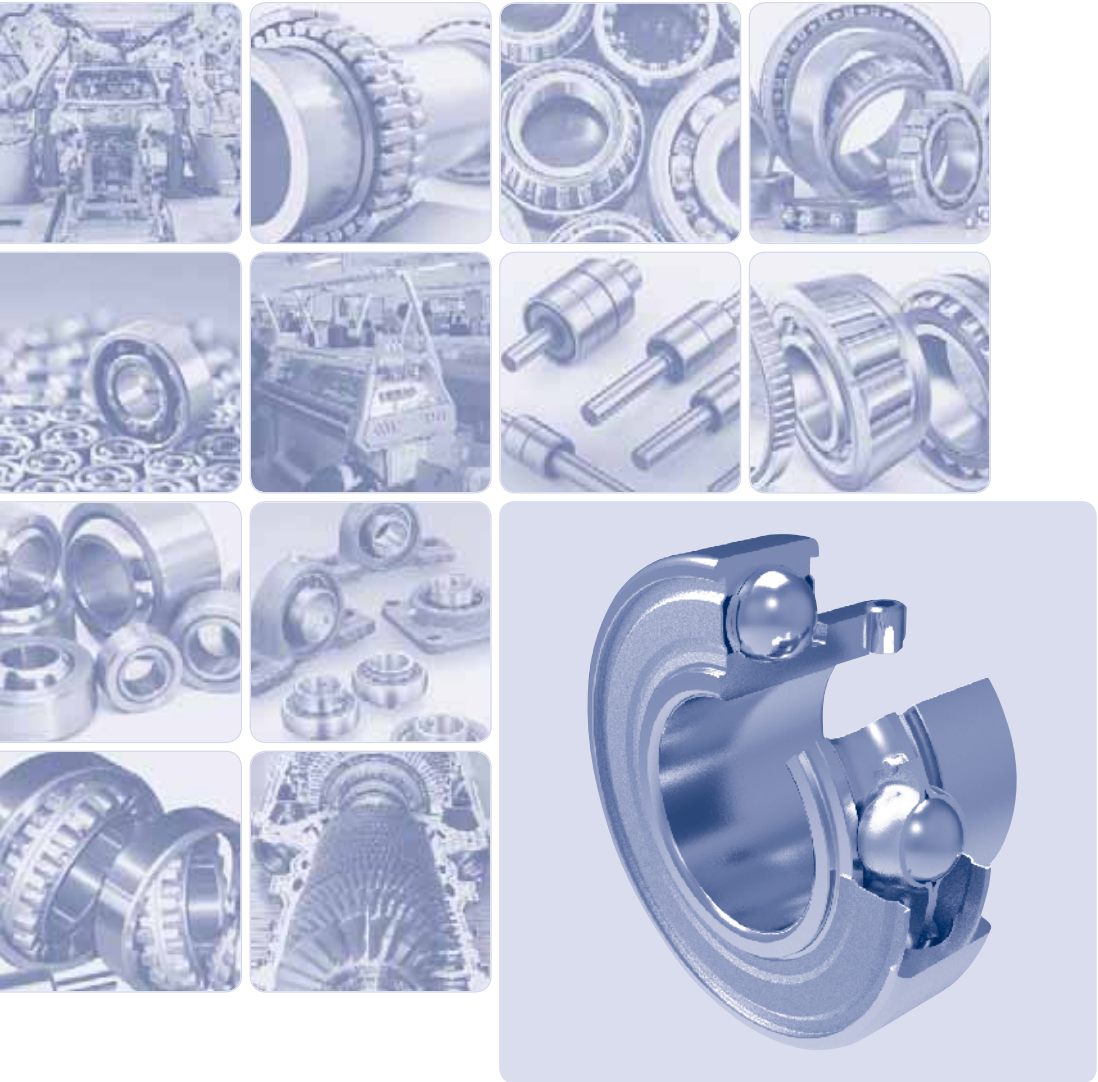

Insert bearings and Housing units

Insert bearings

Insert bearings

Insert bearings are single-row ball bearings with double seal on both sides. The outer ring has a spherical surface and can therefore tilt in the housing to compensate any misalignments between the shaft and the housing. The inner ring is wider than the outer ring and is mounted to the shaft using an eccentric adapter ring or screws.

The bearings are filled with a high-quality plastic lubricant, whose properties ensure reliable lubrication, usually throughout the life of the bearing. If necessary, the bearings can be additionally lubricated using a lubrication head located on the housing.

Insert bearings are suitable for short shaft arrangements and for arrangements with small thermal dilatations, which are compensated by the axial clearance in the bearings or by the pliancy of the structure on which the bearing housings are mounted.

The maximum operating temperature is 100°C and the minimum operating temperature is -30°C.

Construction Design

Insert bearings are available in several designs, which cover different technical requirements. All insert bearings have a spherical surface of the outer ring and a seal that provides optimal protection against contamination, especially in a polluted operating environment.

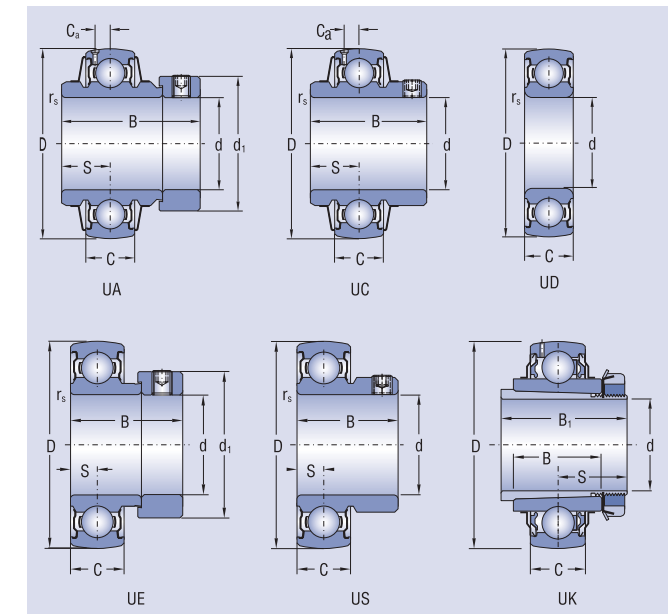

UA Design

The UA design insert bearings have a prolonged inner ring on both sides. The design is similar to the UC bearing design. The only difference is the shaft mounting. The inner ring of the bearing is mounted on the shaft using an eccentric adapter ring, which is fixed to the shaft by screw(s). The UA design enables fast, efficient and easy mounting of bearings on the shaft and they are suitable for one-directional rotation.

UC Design The UC design insert bearings have a prolonged inner ring on both sides, so a more effective seal can be used. Bearing units with these bearings have larger internal space for a larger quantity of plastic lubricant and hence extended servicing time, especially for operations in difficult conditions. Like the US design, the inner ring is fixed to the shaft with two screws. The UC design bearings can be additionally lubricated through the lubrication bores on the outer ring.

UE Design The UA design insert bearings have a prolonged inner ring on one side and are mounted on the shaft using an eccentric adapter ring. These bearings are suitable for applications with one-directional rotation.

UD Design The UD design insert bearings have the outer and inner ring of equal width.

US Design The US design insert bearings have a prolonged inner ring on one side. These bearings are suitable for standard applications with changes in the direction of rotation. The inner ring is fixed to the shaft with two screws, which are placed at a 120° angle. This fixing guarantees fast, efficient and easy mounting of the bearing on the shaft.

UK Design The UK design insert bearings have a prolonged inner ring on both sides and a tapered bore – conicity of 1:12. They are mounted on the shaft using an adapter sleeve. The designation of adapter sleeves belonging to the individual bearings with a tapered bore is given in the dimension tables. The UK design insert bearings have the ability to withstand heavy loads. Because they are mounted using adapter sleeves, they can be mounted on shafts of different diameters by replacing different types of adapter sleeves, which is more versatile than other types of insert bearings.

Boundary Dimensions The boundary dimensions of insert bearings and eccentric adapter rings comply with the ISO 9628 international standard.

Designation The designation of insert bearings with the basic design is given in the dimension tables.

Cages Insert bearings have cages pressed from sheet steel, which are not designated.

Precision Insert bearings are normally manufactured with normal precision grade P0 (the P0 mark is not designated). For special bearing arrangements, bearings are manufactured with higher precision grade P6 and P5. The supply of such bearings needs to be negotiated in advance.

Insert bearings have a uniform bore diameter tolerance – H6. This tolerance ensures a movable arrangement in each case when machining a shaft in the tolerance zone h. As a rule, it is sufficient to manufacture the shaft from drawn steel produced in tolerance h8 to h11. For higher loads and higher speeds, it is necessary to manufacture the shaft in tolerance h6 or h7.

Radial Clearance Insert bearings have the C3 radial clearance, which is not designated and whose range corresponds to the range of radial clearances of single-row ball bearings of the same dimensions. The supply of bearings with a different range of radial clearance needs to be negotiated in advance.

Limiting Speed The limiting speed that the insert bearings can achieve depends primarily on the arrangement on the shaft.

The following table shows the limiting speeds for the various shaft diameter tolerances.

Bore diameter d mm	Limiting speed with a plastic lubricant for bearings of the UA, UE, UD and UC series with shaft tolerance				
	h6	h7	h8	h9	h11
17	9 500	6 000	4 300	1 500	950
20	8 500	5 300	3 800	1 300	850
25	7 000	4 500	3 200	1 000	700
30	6 300	4 000	2 800	900	630
35	5 300	3 400	2 200	750	530
40	4 800	3 000	1 900	670	480
45	4 300	2 600	1 700	600	430
50	4 000	2 400	1 600	560	400
55	3 600	2 000	1 400	500	360
60	3 400	1 900	1 300	480	340
65	3 000	1 700	1 100	430	300
70	2 800	1 600	1 000	400	280
80	2 400	1 400	900	360	240
90	2 000	1 200	800	320	200

Minimum Load Insert bearings must be subjected to a certain minimum load to ensure reliable bearing function. The minimum load is 1% of the basic dynamic bearing capacity.

Radial and Static Equivalent Dynamic Load

Radial Equivalent Dynamic Load

The equivalent dynamic load of insert bearings is determined in the same way as for standard ball bearings:

$$P_r = F_r \quad \text{pre } F_a/F_r \leq e$$

$$P_r = 0,56 \cdot F_r + Y \cdot F_a \quad \text{pre } F_a/F_r > e$$

Radial Equivalent Static Load

The following applies to the static load of insert bearings:

$$P_{0r} = 0,6 \cdot F_r + 0,5 \cdot F_a \quad \text{pre } (P_{0r} \geq F_r)$$

Insert bearings UC200

d = 12 - 90 mm

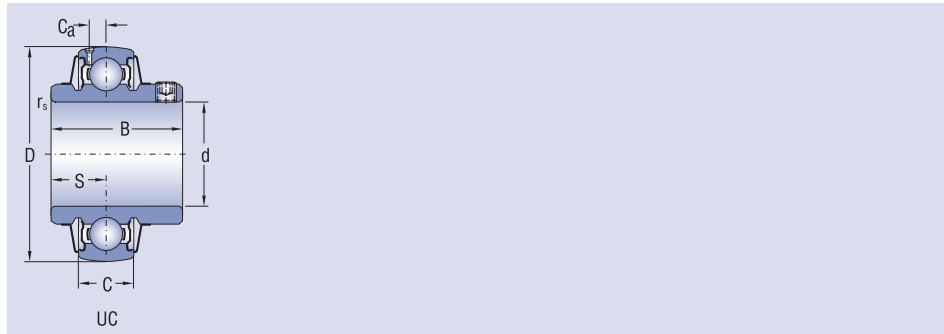

Dimensions									Bearing designation	Set screw	Basic load rating		Weight
d	D	d ₁	B	s	C	C ₁	r	G			dynamic	static	
mm											kN	kg	
12	47	28.6	31	12.7	17	3.6	0.6	4.5	UC201	M6x1	12.8	6.7	0.21
15	47	28.6	31	12.7	17	3.6	0.6	4.5	UC202	M6x1	12.8	6.7	0.19
17	47	28.6	31	12.7	17	3.6	0.6	4.5	UC203	M6x1	12.8	6.7	0.18
20	47	28.6	31	12.7	17	4	1	4.5	UC204	M6x1	12.8	6.7	0.16
25	52	33.8	34.1	14.3	17	4.3	1	5.0	UC205	M6x1	14.0	7.9	0.22
30	62	39.8	38.1	15.9	19	5	1	5	UC206	M6x1	19.5	11.3	0.35
35	72	46.8	42.9	17.5	20	5.7	1.1	6	UC207	M8x1	25.7	15.2	0.52
40	80	52.5	49.2	19	21	6.2	1.1	8	UC208	M8x1	32.0	17.8	0.70
45	85	57.3	49.2	19	22	6.3	1.1	8	UC209	M8x1	32.7	20.2	0.74
50	90	62.1	51.6	19	24	6.5	1.1	9	UC210	M10x1	35.1	23.2	0.83
55	100	70.0	55.6	22.2	25	7.2	1.5	9	UC211	M10x1	43.3	29.2	1.15
60	110	77.0	65.1	25.4	27	8.2	1.5	10	UC212	M10x1	47.8	32.8	1.15
65	120	82.1	65.1	25.4	27	8	1.5	10	UC213	M10x1	57.2	40.1	1.96
70	125	87.0	74.6	30.2	29	9	1.5	12	UC214	M12x1.5	60.8	40.5	2.18
75	130	91.5	77.8	33.3	30	9	1.5	12	UC215	M12x1.5	66.8	49.5	2.42
80	140	98.5	82.6	33.3	33	10.3	2	14	UC216	M12x1.5	71.5	54.2	2.82
85	150	105.0	85.7	34.1	36	11	2	14	UC217	M12x1.5	83.5	63.8	3.40
90	160	111.5	96	39.7	37	12	2	14	UC218	M12x1.5	95.8	71.5	4.30

Insert bearings UA200

d = 15 - 80 mm

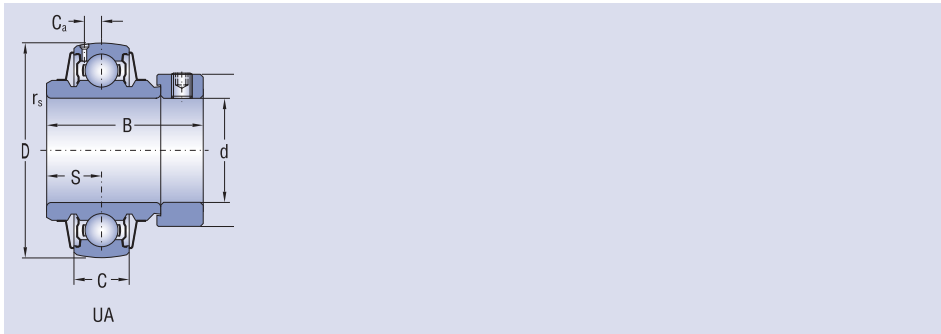

Dimensions							Bearing designation	Set screw	Basic load rating		Weight	
d	D	C	C ₁	s	B ₁	k			dynamic	static		
mm												
15	40	14	3.6	13.9	37.3	28.6	UA202	M6x1	12.8	6.7	0.22	
17	40	14	3.6	13.9	37.3	28.6	UA203	M6x1	12.8	6.7	0.20	
20	47	16	4	17.1	43.7	33.3	UA204	M6x1	12.8	6.7	0.22	
25	52	17	4.3	17.4	44.3	38.1	UA205	M6x1	14.0	7.9	0.25	
30	62	19	5	18.3	48.4	44.5	UA206	M8x1	19.5	11.3	0.41	
35	72	20	5.7	18.8	51.1	55.6	UA207	M8x1	25.7	15.2	0.60	
40	80	21	6.2	21.4	56.3	60.3	UA208	M8x1	32.0	17.8	0.78	
45	85	22	6.3	21.4	56.3	63.5	UA209	M8x1	32.7	20.2	0.85	
50	90	23	6.5	24.6	62.7	69.9	UA210	M8x1	35.1	23.2	1.01	
55	100	25	7.2	27.8	71.4	76.2	UA211	M10x1	43.3	29.2	1.39	
60	110	27	8.2	31	77.8	84.2	UA212	M10x1	47.8	32.8	1.87	
65	120	28	8	34.1	85.7	97	UA213	M10x1	57.2	40.1	2.41	
70	125	30	9	34.1	85.7	97	UA214	M10x1	60.8	40.5	2.57	
75	130	30	9	37.3	92.1	102	UA215	M12x1	66.8	49.5	2.85	
80	140	33	10.3	40.5	100	111.1	UA216	M12x1	71.5	54.2	3.12	

Insert bearings UE200

d = 12 - 60 mm

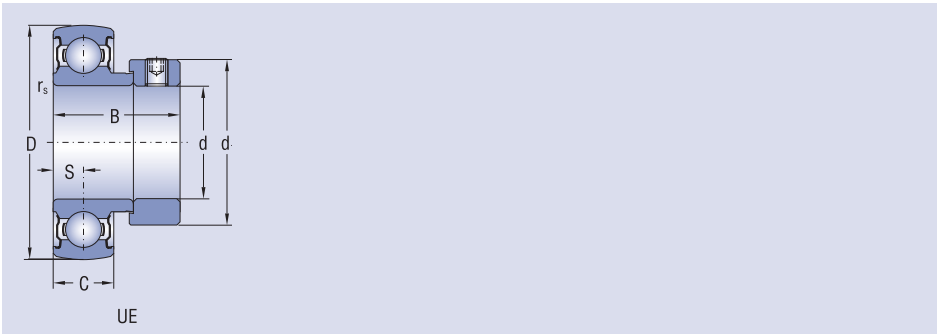

Dimensions							Bearing designation	Basic load rating		Weight
d	D	C	C ₁	s	B ₁	d ₁		dynamic	static	
mm								kN		kg
12	40	12	3.6	6	28.6	28.6	UE201	9.6	4.6	0.14
15	40	12	3.6	6	28.6	28.6	UE202	9.6	4.6	0.13
17	40	12	3.6	6	28.6	28.6	UE203	9.6	4.6	0.12
20	47	14	4	7.5	31	33.3	UE204	12.8	6.7	0.15
25	52	15	4.3	7.5	31	38.1	UE205	14.0	7.9	0.19
30	62	16	5	9	35.7	44.5	UE206	19.5	11.3	0.31
35	72	17	5.7	9.5	38.9	55.6	UE207	25.7	15.2	0.50
40	80	18	6.2	11	43.7	60.3	UE208	32.0	17.8	0.66
45	85	19	6.3	11	43.7	63.5	UE209	32.7	20.2	0.73
50	90	20	6.5	11	43.7	69.9	UE210	35.1	23.2	0.82
55	100	21	7.2	12	48.4	76.2	UE211	43.3	29.2	0.87
60	110	22	8.2	13.5	53.1	84.2	UE212	47.8	32.8	1.30

Insert bearings UD200

d = 12 - 50 mm

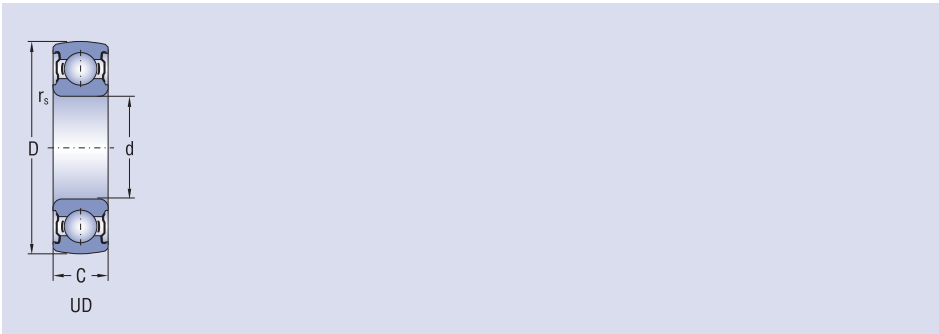

Dimensions			Bearing designation	Basic load rating		Weight
d	D	B		dynamic	static	
mm				kN		kg
12	32	10	UD201	12.8	6.7	0.04
15	35	11	UD202	12.8	6.7	0.04
17	40	12	UD203	12.8	6.7	0.06
20	47	14	UD204	12.8	6.7	0.10
25	52	15	UD205	14.0	7.9	0.13
30	62	16	UD206	19.5	11.3	0.20
35	72	17	UD207	25.7	15.2	0.29
40	80	18	UD208	32.0	17.8	0.37
45	85	19	UD209	32.7	20.2	0.46
50	90	20	UD210	35.1	23.2	0.57

Insert bearings US200

d = 12 - 60 mm

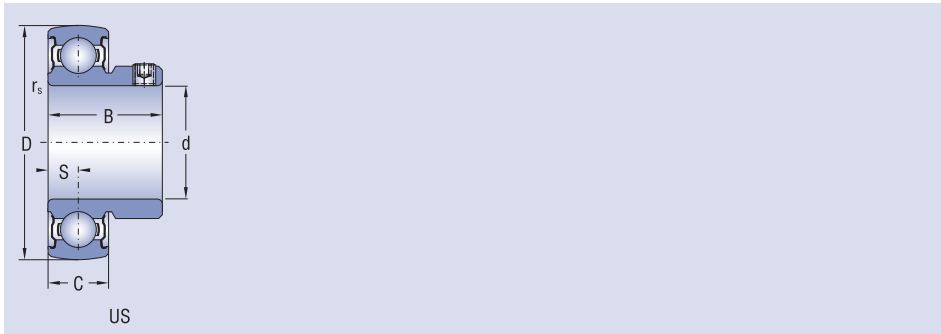

Dimensions						Bearing designation	Basic load rating		Weight
d	D	C	C ₁	s	B ₁		dynamic	static	
mm							kN		kg
12	40	12	3.6	6	22	US201	9.6	4.6	0.10
15	40	12	3.6	6	22	US202	9.6	4.6	0.10
17	40	12	3.6	6	22	US203	9.6	4.6	0.10
20	47	14	4	7	25	US204	12.8	6.7	0.12
25	52	15	4.3	7.5	27	US205	14.0	7.9	0.16
30	62	16	5	8	30	US206	19.5	11.3	0.25
35	72	17	5.7	8.5	32	US207	25.7	15.2	0.36
40	80	18	6.2	9	34	US208	32.0	17.8	0.45
45	85	19	6.3	10.2	41.2	US209	32.7	20.2	0.56
50	90	20	6.5	10.9	43.5	US210	35.1	23.2	0.62
55	100	21	7.2	11.8	45.3	US211	43.3	29.2	1.10
60	110	22	8.2	14.9	53.7	US212	47.8	32.8	1.30

Bearing units

Bearing units

Bearing units are a combination of insert bearings and a bearing housing, which can be in different shapes. Bearing units are supplied pre-assembled. Bearings contain lubricant for longer life. If necessary, the units can be additionally lubricated. The threaded bore for mounting a lubricator is closed with a plastic plug. The lubricator is a part of the supply and is packaged separately.

Use

Bearing units are mainly used in agricultural machinery, transport equipment, food machinery, etc.

Misalignment

Bearing units are self-aligning due to the spherical shape of the seat and bearing. A bearing unit allows angular movement in all directions. This solution to some extent compensates the misalignment of the shaft.

Bearing Housings

Bearing housings include pillow block units (the P construction design), flanged units (the F construction design) and take-up units (the T construction design).

Bearing housings are made of grey cast iron as a standard. In special cases, a supply from another material may be arranged. All external surfaces of the bearing housing that are not machined are protected by paint. Functional machined surfaces are protected by an anti-corrosion protective layer, which is easily removable during mounting.

Boundary Dimensions of Bearing Housings

The boundary dimensions of bearing housings comply with ISO 3228.

Replaceability of Bearings

Insert bearings in the bearing unit are replaceable. In the event of a bearing malfunction, a new bearing can be mounted in the existing bearing housing.

Designation

The designation of the bearing units is given in the table section, which also contains the designation of the respective bearing and bearing housing.



Plummer block housing units

d = 12 - 90 mm

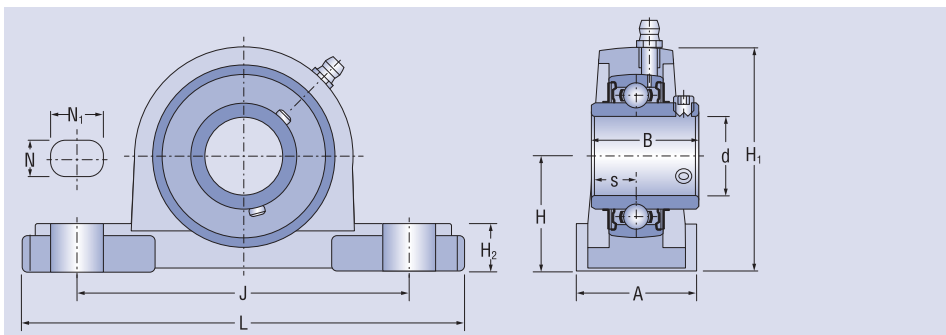

Dimensions												Bearing unit	Bolt size	Insert bearing	Housing	Weight
d	L	J	A	N	N ₁	H	H ₁	H ₂	B	S						
mm																kg
12	127	95	38	13	19	30.2	62	14	31.0	12.7	UCP201	M10	UC201	P203	0.7	
15	127	95	38	13	19	30.2	62	14	31.0	12.7	UCP202	M10	UC202	P203	0.7	
17	127	95	38	13	19	30.2	62	14	31.0	12.7	UCP203	M10	UC203	P203	0.7	
20	127	95	38	13	19	33.3	65	14	31.0	12.7	UCP204	M10	UC204	P204	0.7	
25	140	105	38	13	19	36.5	70	15	34.1	14.3	UCP205	M10	UC205	P205	0.8	
30	165	121	48	17	21	42.9	83	17	38.1	15.9	UCP206	M12	UC206	P206	1.3	
35	167	127	48	17	21	47.6	92	18	42.9	17.5	UCP207	M12	UC207	P207	1.6	
40	184	137	54	17	21	49.2	98	18	49.2	19.0	UCP208	M12	UC208	P208	1.9	
45	190	146	54	17	21	54.0	106	20	49.2	19.0	UCP209	M12	UC209	P209	2.2	
50	206	159	60	20	25	57.2	112	21	51.6	19.0	UCP210	M16	UC210	P210	2.6	
55	219	171	60	20	25	63.5	126	22	55.6	22.2	UCP211	M16	UC211	P211	3.3	
60	241	184	70	20	25	69.8	137	25	65.1	25.4	UCP212	M16	UC212	P212	4.6	
65	265	203	70	25	29	76.2	150	27	65.1	25.4	UCP213	M20	UC213	P213	5.9	
70	266	210	72	25	30	79.4	156	27	74.6	30.2	UCP214	M20	UC214	P214	6.6	
75	275	217	74	25	30	82.6	163	28	77.8	33.3	UCP215	M20	UC215	P215	7.4	
80	292	232	78	25	30	88.9	175	30	82.6	33.3	UCP216	M20	UC216	P216	9.0	
85	310	247	83	25	30	95.2	187	32	85.7	34.1	UCP217	M20	UC217	P217	11.0	
90	327	262	88	27	33	101.6	200	34	96.0	39.7	UCP218	M22	UC218	P218	13.0	

Take-up housing units

d = 17 - 85 mm

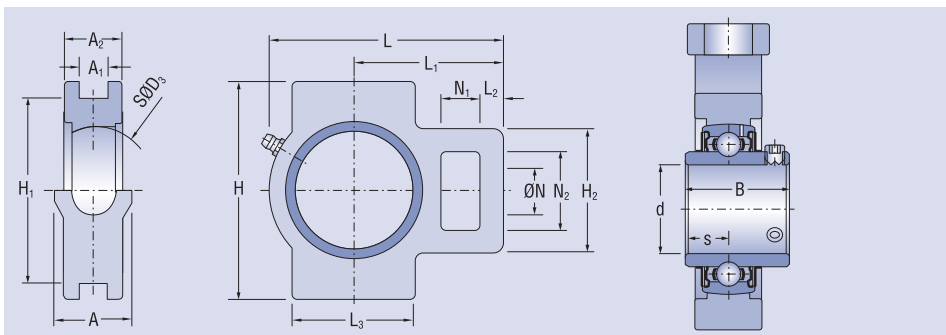

Dimensions																Bearing unit	Insert bearing	Housing	Weight
d	B	s	L	L ₁	L ₂	L ₃	H	H ₁	H ₂	A	A ₁	A ₂	N	N ₁	N ₂				
17	31.0	12.7	94	61	10	51	89	76	51	32	12	21	19	16	32	UCT203	UC203	T204	0.8
20	31.0	12.7	94	61	10	51	89	76	51	32	12	21	19	16	32	UCT204	UC204	T204	0.8
25	34.1	14.3	97	62	10	51	89	76	51	32	12	24	19	16	32	UCT205	UC205	T205	0.9
30	38.1	15.9	113	70	10	57	102	89	56	37	12	28	22	16	37	UCT206	UC206	T206	1.3
35	42.9	17.5	129	78	13	64	102	89	64	37	12	30	22	16	37	UCT207	UC207	T207	1.7
40	49.2	19.0	144	88	16	83	114	102	83	49	16	33	29	19	49	UCT208	UC208	T208	2.3
45	49.2	19.0	144	87	16	83	117	102	83	49	16	35	29	19	49	UCT209	UC209	T209	2.4
50	51.6	19.0	149	90	16	86	117	102	83	49	16	37	29	19	49	UCT210	UC210	T210	2.5
55	55.6	22.2	171	106	19	95	146	130	102	64	22	38	35	25	64	UCT211	UC211	T211	4.0
60	65.1	25.4	194	119	19	102	146	130	102	64	22	42	35	32	64	UCT212	UC212	T212	4.9
65	65.1	25.4	224	137	21	121	167	151	111	70	26	44	41	32	70	UCT213	UC213	T213	7.0
70	74.6	30.2	224	137	21	121	167	151	111	70	26	46	41	32	70	UCT214	UC214	T214	7.1
75	77.8	33.3	232	140	21	121	167	151	111	70	26	48	41	32	70	UCT215	UC215	T215	7.5
80	82.6	33.3	235	140	21	121	184	165	111	70	26	51	41	32	70	UCT216	UC216	T216	8.2
85	85.7	34.1	260	162	29	157	198	173	124	73	30	54	48	38	73	UCT217	UC217	T217	11.0

Four-bolt flanged housing units

d = 17 - 90 mm

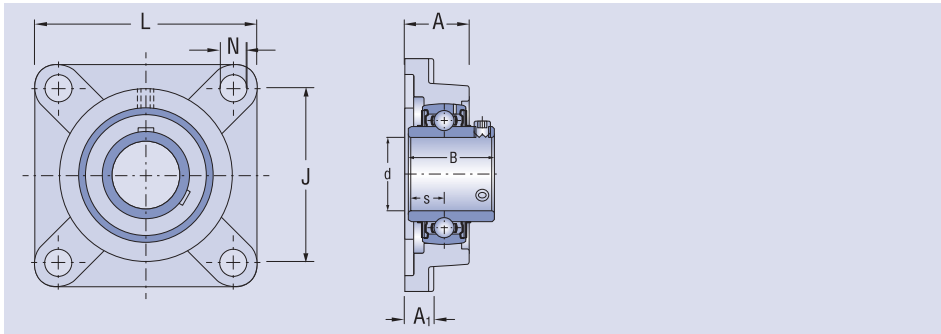

Dimensions								Bearing unit	Bolt size	Insert bearing	Housing	Weight
d	L	J	B	A	A ₁	N	S					
mm												kg
17	86	64	31.0	33.3	12	12	12.7	UCF203	M10	UC203	F204	0.6
20	86	64	31.0	33.3	12	12	12.7	UCF204	M10	UC204	F204	0.7
25	95	70	34.1	35.8	14	12	14.3	UCF205	M10	UC205	F205	0.9
30	108	83	38.1	40.2	14	12	15.9	UCF206	M10	UC206	F206	1.1
35	117	92	42.9	44.4	16	14	17.5	UCF207	M12	UC207	F207	1.5
40	130	102	49.2	51.2	16	16	19.0	UCF208	M14	UC208	F208	1.9
45	137	105	49.2	52.2	18	16	19.0	UCF209	M14	UC209	F209	2.3
50	143	111	51.6	54.6	18	16	19.0	UCF210	M16	UC210	F210	2.7
55	162	130	55.6	58.4	20	19	22.2	UCF211	M16	UC211	F211	3.9
60	175	143	65.1	68.7	20	19	25.4	UCF212	M16	UC212	F212	4.7
65	187	149	65.1	69.7	22	19	25.4	UCF213	M16	UC213	F213	5.7
70	193	152	74.6	75.4	22	19	30.2	UCF214	M16	UC214	F214	6.1
75	200	159	77.8	78.5	22	19	33.3	UCF215	M16	UC215	F215	6.9
80	208	165	82.6	83.3	22	23	33.3	UCF216	M20	UC216	F216	8.1
85	220	175	85.7	87.6	24	23	34.1	UCF217	M20	UC217	F217	9.3
90	235	187	96.0	96.3	24	23	39.7	UCF218	M20	UC218	F218	11.0

Two-bolt flanged housing units

d = 12 - 90 mm

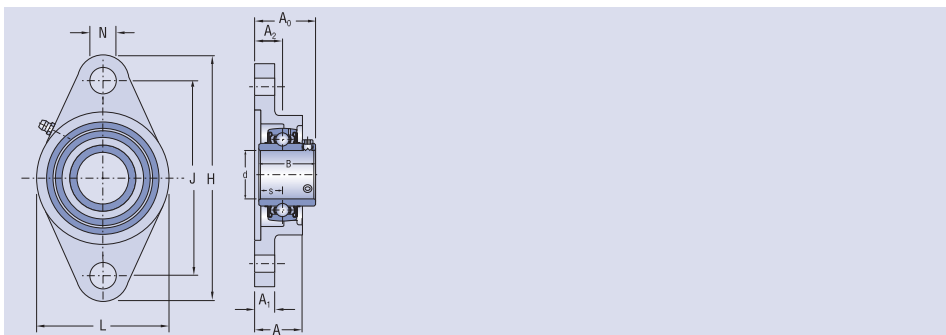

Dimensions											Bearing unit	Bolt size	Insert bearing	Housing	Weight
d	H	J	L	A	A ₁	A ₂	A ₀	N	s						
mm															
12	113	90	60	25.5	12	15	33.3	12	12.7	UCFL201	M10	UC201	FL204	0.5	
15	113	90	60	25.5	12	15	33.3	12	12.7	UCFL202	M10	UC202	FL204	0.5	
17	113	90	60	25.5	12	15	33.3	12	12.7	UCFL203	M10	UC203	FL204	0.5	
20	113	90	60	25.5	12	15	33.3	12	12.7	UCFL204	M10	UC204	FL204	0.5	
25	130	99	68	27.0	14	16	35.8	16	14.3	UCFL205	M14	UC205	FL205	0.6	
30	148	117	80	31.0	14	18	40.2	16	15.9	UCFL206	M14	UC206	FL206	0.9	
35	161	130	90	34.0	16	19	44.4	16	17.5	UCFL207	M14	UC207	FL207	1.2	
40	175	144	100	36.0	16	21	51.2	16	19.0	UCFL208	M14	UC208	FL208	1.5	
45	188	148	108	38.0	18	22	52.2	19	19.0	UCFL209	M16	UC209	FL209	1.9	
50	197	157	115	40.0	18	22	54.6	19	19.0	UCFL210	M16	UC210	FL210	2.2	
55	224	184	130	43.0	18	25	58.4	18	22.2	UCFL211	M16	UC211	FL211	3.1	
60	250	202	140	48.0	18	29	68.7	18	25.4	UCFL212	M16	UC212	FL212	4.0	
65	258	210	155	50.0	20	30	69.7	23	25.4	UCFL213	M20	UC213	FL213	5.0	
70	265	216	160	54.0	20	31	75.4	23	30.2	UCFL214	M20	UC214	FL214	5.6	
75	275	225	164	55.0	22	34	78.5	23	33.3	UCFL215	M20	UC215	FL215	6.0	
80	290	233	180	58.0	22	34	83.3	25	33.3	UCFL216	M22	UC216	FL216	7.8	
85	305	248	190	63.0	22	36	87.6	25	34.1	UCFL217	M22	UC217	FL217	9.8	
90	320	265	205	68.0	23	40	96.3	25	39.7	UCFL218	M22	UC218	FL218	12.4	



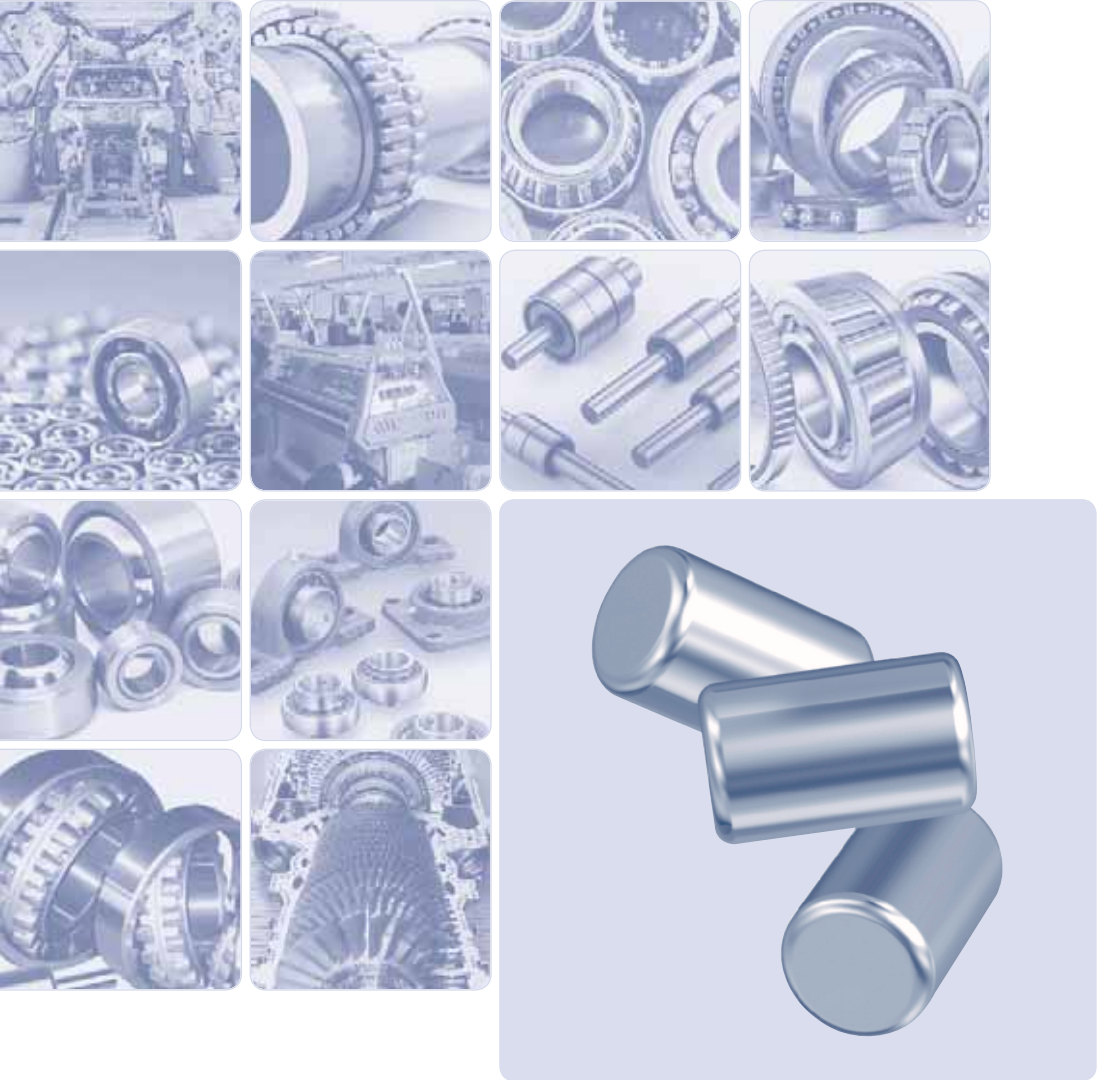

Accessories

Accessories

The term “accessories” involve standardized machine components used for locking the rolling bearings on the shaft or in the housing bore. These are: adapter and withdrawal sleeves, locknuts and withdrawal nuts and locking washers.

The adapter sleeves are the most common type used and their mounting is simpler than that of the withdrawal sleeves. The bearings using withdrawal sleeves must be supported by a firm part for ex. shoulder. The withdrawal sleeves have to be locked in place by means of a locknut or end plate.

Adapter sleeves

The adapter sleeves are used for locking the double row self-aligning ball bearings and double row spherical-roller bearings with a taper bore (K) onto the cylindrical shaft. These sleeves make the mounting and dismounting of the bearing much easier and simplify the seating construction.

The adapter sleeves are delivered as a set, including locknut and locking washer.

The designation of the adapter sleeves including nuts and locking devices is indicated in the dimension tables. The boundary dimensions of adapter sleeves correspond to the norm ISO 2982-1.

The adapter sleeves corresponding to the respective bearings with tapered bore are indicated in the dimension tables of double row self-aligning ball bearings and double row spherical-roller bearings.

Withdrawal Sleeves

Withdrawal sleeves are used for locking of the double row spherical-roller bearings with a tapered bore (K) on the cylindrical shafts.

The designation of the withdrawal sleeves including nuts and locking devices is indicated in the dimensions tables. The boundary dimensions of adapter sleeves correspond to the norm ISO 2982-1.

The withdrawal sleeves corresponding to the respective bearings with tapered bore are indicated in the dimension tables of double row spherical-roller bearings.

The nuts for withdrawal are not included and must be ordered separately.

Locknuts and Withdrawal Nuts

The round locknuts are used for locking the inner ring of the bearing on the adapter sleeve or directly on the shaft. The withdrawal nuts are applied for dismounting of double row spherical-roller bearings with a tapered bore secured by a withdrawal sleeve.

The designation of the locknuts and withdrawal nuts is indicated in the dimensions tables.

The boundary dimensions of locknuts and withdrawal nuts correspond to the norm ISO 2982-2.

Locking Washer

The locking washers are used for locking the locknuts. The designation of the locking washers is indicated in the dimensions tables.

The boundary dimensions of locking washers correspond to the norm ISO 2982-2.

Adapter sleeves

d = 14 – 70 mm

Adapter sleeves

d = 75 – 170 mm

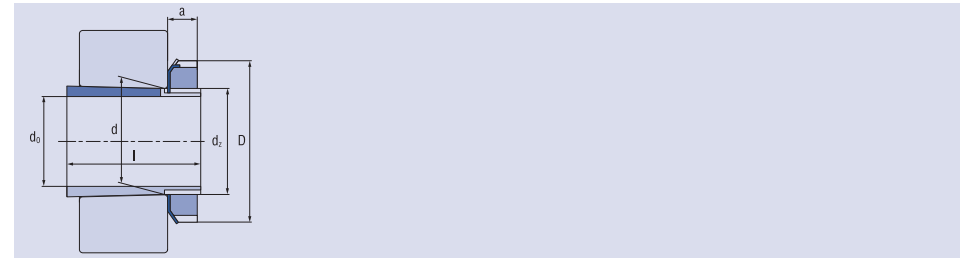
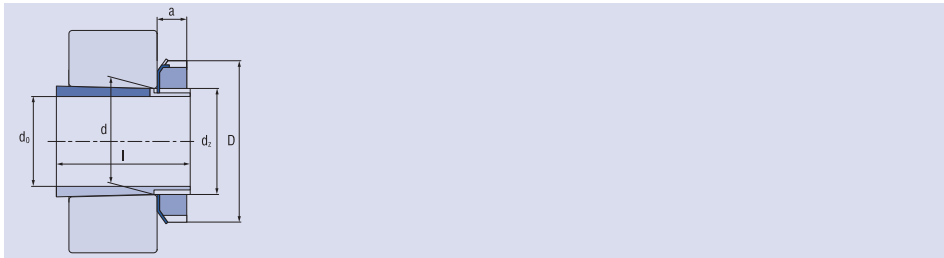

Dimensions						Designation	Mass	The relevant parts	
d ₀	d	d _z	D	l	a			Nuts	Washers
mm							kg		
14	17	M17x1	28	20	6	H203	0.030	KM3	MB3
17	20	M20x1	32	24	7	H204	0.036	KM4	MB4
	20	M20x1	32	28	7	H304	0.045	KM4	MB4
20	25	M25x1.5	38	26	8	H205	0.064	KM5	MB5
	25	M25x1.5	38	29	8	H305	0.071	KM5	MB5
	25	M25x1.5	38	35	8	H2305	0.085	KM5	MB5
25	30	M30x1.5	45	27	8	H206	0.086	KM6	MB6
	30	M30x1.5	45	31	8	H306	0.095	KM6	MB6
	30	M30x1.5	45	38	8	H2306	0.11	KM6	MB6
30	35	M35x1.5	52	29	9	H207	0.12	KM7	MB7
	35	M35x1.5	52	35	9	H307	0.14	KM7	MB7
	35	M35x1.5	52	43	9	H2307	0.16	KM7	MB7
35	40	M40x1.5	58	31	10	H208	0.17	KM8	MB8
	40	M40x1.5	58	36	10	H308	0.19	KM8	MB8
	40	M40x1.5	58	46	10	H2308	0.22	KM8	MB8
40	45	M45x1.5	65	33	11	H209	0.22	KM9	MB9
	45	M45x1.5	65	39	11	H309	0.25	KM9	MB9
	45	M45x1.5	65	50	11	H2309	0.28	KM9	MB9
45	50	M50x1.5	70	35	12	H210	0.26	KM10	MB10
	50	M50x1.5	70	42	12	H310	0.28	KM10	MB10
	50	M50x1.5	70	55	12	H2310	0.35	KM10	MB10
50	55	M55x2	75	37	12	H211	0.28	KM11	MB11
	55	M55x2	75	45	12	H311	0.32	KM11	MB11
	55	M55x2	75	59	12	H2311	0.39	KM11	MB11
55	60	M60x2	80	38	13	H212	0.32	KM12	MB12
	60	M60x2	80	47	13	H312	0.37	KM12	MB12
	60	M60x2	80	62	13	H2312	0.45	KM12	MB12
60	65	M65x2	85	40	14	H213	0.36	KM13	MB13
	65	M65x2	85	50	14	H313	0.42	KM13	MB13
	65	M65x2	85	65	14	H2313	0.52	KM13	MB13
	60	70	M70x2	92	41	14	H214	0.55	KM14
60	70	M70x2	92	52	14	H314	0.67	KM14	MB14
	70	M70x2	92	68	14	H2314	0.88	KM14	MB14
	65	75	M75x2	98	43	15	H215	0.66	KM15
65	75	M75x2	98	55	15	H315	0.78	KM15	MB15
	75	M75x2	98	73	15	H2315	1.08	KM15	MB15
	70	80	M80x2	105	46	17	H216	0.83	KM16
70	80	M80x2	105	59	17	H316	0.96	KM16	MB16
	80	M80x2	105	78	17	H2316	1.22	KM16	MB16

Dimensions						Designation	Mass	The relevant parts	
d ₀	d	d _z	D	l	a			Nuts	Washers
mm							kg		
75	85	M85x2	110	50	18	H217	0.95	KM17	MB17
	85	M85x2	110	63	18	H317	1.12	KM17	MB17
	85	M85x2	110	82	18	H2317	1.28	KM17	MB17
80	90	M90x2	120	52	18	H218	1.12	KM18	MB18
	90	M90x2	120	65	18	H318	1.26	KM18	MB18
	90	M90x2	120	86	18	H2318	1.63	KM18	MB18
85	95	M95x2	125	55	19	H219	1.25	KM19	MB19
	95	M95x2	125	68	19	H319	1.46	KM19	MB19
	95	M95x2	125	90	19	H2319	1.82	KM19	MB19
90	100	M100x2	130	58	20	H220	1.43	KM20	MB20
	100	M100x2	130	71	20	H320	1.65	KM20	MB20
	100	M100x2	130	76	20	H3120	1.82	KM20	MB20
	100	M100x2	130	97	20	H2320	2.08	KM20	MB20
100	110	M110x2	145	77	21	H322	2.11	KM22	MB22
	110	M110x2	145	81	21	H3122	2.37	KM22	MB22
	110	M110x2	145	105	21	H2322	2.75	KM22	MB22
110	120	M120x2	145	72	22	H3024	1.89	KML24	MBL24
	120	M120x2	155	88	22	H3124	2.55	KM24	MB24
	120	M120x2	155	112	22	H2324	3.10	KM24	MB24
115	130	M130x2	155	80	23	H3026	2.85	KML26	MBL26
	130	M130x2	165	92	23	H3126	3.56	KM26	MB26
	130	M130x2	165	121	23	H2326	4.58	KM26	MB26
125	140	M140x2	165	82	24	H3028	3.09	KML28	MBL28
	140	M140x2	180	97	24	H3128	4.18	KM28	MB28
	140	M140x2	180	131	24	H2328	5.47	KM28	MB28
135	150	M150x2	180	87	26	H3030	3.82	KML30	MBL30
	150	M150x2	195	111	26	H3130	5.40	KM30	MB30
	150	M150x2	195	139	26	H2330	6.51	KM30	MB30
140	160	M160x3	190	93	28	H3032	5.13	KML32	MBL32
	160	M160x3	210	119	28	H3132	7.43	KM32	MB32
	160	M160x3	210	147	28	H2332	8.92	KM32	MB32
150	170	M170x3	200	101	29	H3034	5.88	KML34	MBL34
	170	M170x3	220	122	29	H3134	8.22	KM34	MB34
	170	M170x3	220	154	29	H2334	10.05	KM34	MB34
160	180	M180x3	210	109	30	H3036	6.75	KML36	MBL36
	180	M180x3	230	131	30	H3136	9.32	KM36	MB36
	180	M180x3	230	161	30	H2326	11.13	KM36	MB36
170	190	M190x3	220	112	31	H3038	7.35	KML38	MBL38
	190	M190x3	240	141	31	H3138	10.67	KM38	MB38
	190	M190x3	240	169	31	H2338	12.28	KM38	MB38

Adapter sleeves

d = 180 – 380 mm

Withdrawal Sleeves

d = 35 – 115 mm

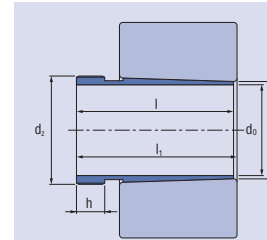
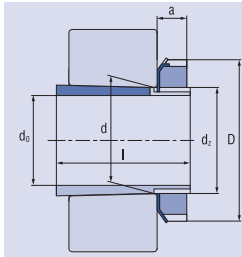

Dimensions						Designation	Mass	The relevant parts	
d ₀	d	d _z	D	l	a			Nuts	Washers
mm							kg		
180	200	M200x3	240	120	32	H3040	9.04	KML40	MBL40
	200	M200x3	250	150	32	H3140	12.03	KM40	MB40
	200	M200x3	250	176	32	H2340	13.72	KM40	MB40
200	220	M220x4	260	126	30	H3044	9.90	HML44	MBL44
	220	M220x4	280	161	35	H3144	15.00	HM44	MB44
	220	M220x4	280	186	35	H2344	17.00	HM44	MB44
220	240	M240x4	290	133	34	H3048	12.00	HML48	MBL48
	240	M240x4	300	172	37	H3148	16.00	HM48	MB48
	240	M240x4	300	199	37	H2348	19.00	HM48	MB48
240	260	Tr260x4	310	145	34	H3052	13.05	HML52	MBL52
	260	Tr260x4	330	190	39	H3152	21.00	HM52	MB52
	260	Tr260x4	330	211	39	H2352	23.00	HM52	MB52
260	280	Tr280x4	330	152	38	H3056	16.00	HML56	MBL56
	280	Tr280x4	350	195	41	H3156	23.00	HM56	MB56
	200	Tr280x4	350	224	41	H2356	27.00	HM56	MB56
280	300	Tr300x4	360	168	42	H3060	20.50	HML60	MSL60
	300	Tr300x4	380	208	40	H3160	29.00	HM60	MS60
	300	Tr300x4	380	240	40	H2360	32.00	HM60	MS60
300	320	Tr320x5	380	171	42	H3064	22.00	HML64	MSL64
	320	Tr320x5	400	226	42	H3164	32.00	HM64	MS64
	320	Tr320x5	400	258	42	H2364	35.00	HM64	MS64
320	340	Tr340x5	400	187	45	H3068	27.00	HML68	MSL68
	340	Tr340x5	440	254	55	H3168	50.00	HM68	MS68
	340	Tr340x5	440	288	72	H2368	51.50	HM68	MS68
340	360	Tr360x5	420	188	45	H3072	29.00	HML72	MSL72
	360	Tr360x5	460	259	58	H3172	56.00	HM72	MS72
	360	Tr360x5	460	299	75	H2372	60.50	HM72	MS72
360	380	Tr380x5	450	193	48	H3076	35.50	HML76	MSL76
	380	Tr380x5	490	264	60	H3176	61.50	HM76	MS76
	380	Tr380x5	490	310	60	H2376	69.50	HM76	MS76
380	400	Tr400x5	470	210	52	H3080	40.00	HML80	MSL80
	400	Tr400x5	520	272	62	H3180	73.00	HM80	MS80
	400	Tr400x5	520	328	62	H2380	81.00	HM80	MS80

Dimensions						Designation	Mass	The relevant parts	
d ₀	d	d _z	l	l ₁	h			Nuts	Washers
mm							kg		
35	40	M45x1.5	29	32	6	AH308	0.093	KM9	
	40	M45x1.5	40	43	7	AH2308	0.129	KM9	
40	45	M50x1.5	31	34	6	AH309	0.12	KM10	
	45	M50x1.5	44	47	7	AH2309	0.16	KM10	
45	50	M55x2	35	38	7	AHX310	0.132	KM11	
	50	M55x2	50	53	9	AHX2310	0.190	KM11	
50	55	M60x2	37	40	7	AHX311	0.168	KM12	
	55	M60x2	54	57	10	AHX2311	0.257	KM12	
55	60	M65x2	40	43	8	AHX312	0.194	KM13	
	60	M65x2	58	61	11	AHX2312	0.298	KM13	
60	65	M70x2	42	45	8	AH313	0.20	KM14	
	65	M70x2	61	64	12	AH2313	0.36	KM14	
65	70	M75x2	43	47	8	AH314	0.25	KM15	
	70	M75x2	64	68	12	AHX2314	0.47	KM15	
70	75	M80x2	45	49	8	AH315	0.30	KM16	
	75	M80x2	68	72	12	AHX2315	0.48	KM16	
75	80	M90x2	48	52	8	AH316	0.37	KM18	
	80	M90x2	71	75	12	AHX2316	0.58	KM18	
80	85	M95x2	52	56	9	AHX317	0.44	KM19	
	85	M95x2	74	78	13	AHX2317	0.66	KM19	
85	90	M100x2	53	57	9	AHX318	0.47	KM20	
	90	M100x2	63	67	10	AHX3218	0.58	KM20	
	90	M100x2	79	83	14	AHX2318	0.77	KM20	
90	95	M105x2	57	61	10	AHX319	0.54	KM21	
	95	M105x2	85	89	16	AHX2319	0.90	KM21	
95	100	M110x2	59	63	10	AHX320	0.59	KM22	
	100	M105x2	62	71	12	AH24020	0.50	KM21	
	100	M110x2	64	68	11	AHX3120	0.67	KM22	
	100	M110x2	73	77	11	AHX3220	0.77	KM22	
105	100	M110x2	90	94	16	AHX2320	1.02	KM22	
	110	M120x2	63	67	12	AHX322	0.75	KM24	
	110	M120x2	68	72	11	AHX3122	0.77	KM24	
	110	M120x2	82	86	11	AHX3222	0.98	KM24	
115	110	M115x2	82	91	13	AH24122	0.71	KM23	
	110	M110x2	98	102	16	AHX2322	1.38	KM24	
	120	M130x2	60	64	13	AHX3024	0.75	KM26	
	120	M125x2	73	82	13	AH24024	0.71	KM25	
120	120	M130x2	75	79	12	AHX3124	0.95	KM26	
	120	M130x2	90	94	13	AHX3224	1.26	KM26	
	120	M130x2	93	102	13	AH24124	1.01	KM26	
	120	M130x2	105	109	17	AHX2324	1.58	KM26	

Withdrawal Sleeves

d = 125 – 170 mm

Withdrawal Sleeves

d = 180 – 260 mm

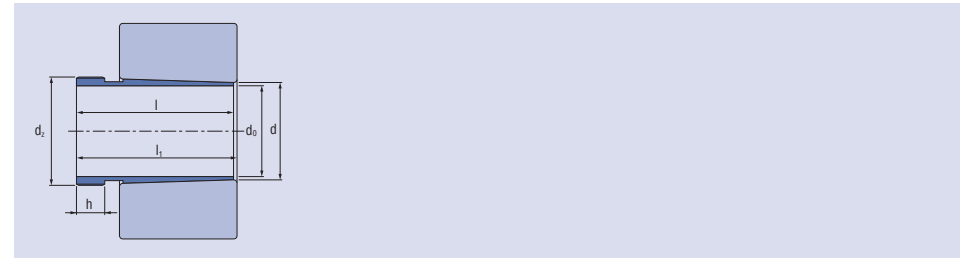
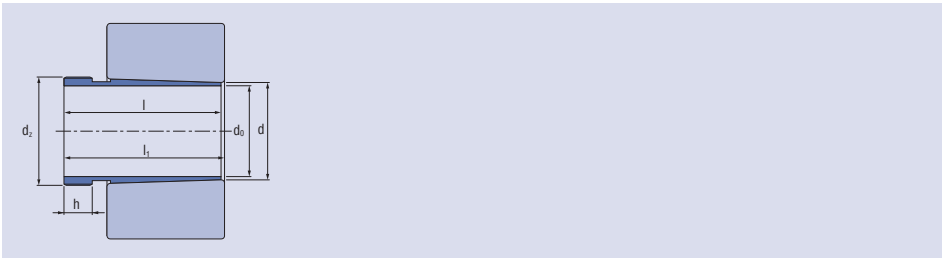

Dimensions						Designation	Mass	The relevant parts
d ₀	d	d _z	l	l ₁	h			
mm							kg	
125	130	M140x2	67	71	14	AHX3026	0.92	KM28
	130	M140x2	78	82	12	AHX3126	1.10	KM28
	130	M135x2	83	93	14	AH24026	0.88	KM27
	130	M140x2	94	104	14	AH24126	1.14	KM28
	130	M145x2	98	102	15	AHX3226	1.52	KM29
	130	M145x2	115	119	19	AHX2326	1.95	KM29
135	140	M150x2	77	82	14	AHX3028	1.12	KM30
	140	M150x2	83	88	14	AHX3128	1.29	KM30
	140	M145x2	83	93	14	AH24028	0.95	KM29
	140	M150x2	99	109	14	AH24128	1.29	KM30
	140	M155x2	104	109	15	AHX3228	1.85	KM31
	140	M155x2	125	130	20	AHX2328	2.37	KM31
145	150	M160x3	72	77	15	AHX3030	1.16	KM32
	150	M155x2	90	101	15	AH24030	1.08	KM31
	150	M165x3	96	101	15	AHX3130	1.70	KM33
	150	M165x3	114	119	17	AHX3230	2.10	KM33
	150	M160x3	115	126	15	AHX24130	1.55	KM32
	150	M165x3	135	140	24	AHX2330	2.75	KM33
150	160	M170x3	77	82	16	AH3032	2.05	KM34
	160	M170x3	95	106	15	AH24032	2.31	KM34
	160	M180x3	103	108	16	AH3132	2.97	KM36
	160	M180x3	124	130	20	AH3232	3.65	KM36
	160	M170x3	124	135	15	AH24132	3.00	KM34
	160	M180x3	140	146	24	AH2332	4.35	KM36
160	170	M180x3	85	90	17	AH3034	2.46	KM36
	170	M190x3	104	109	16	AH3134	3.45	KM38
	170	M180x3	106	117	16	AH24034	2.73	KM36
	170	M180x3	125	136	16	AH24134	3.26	KM36
	170	M190x3	134	140	24	AH3234	4.81	KM38
	170	M190x3	146	152	24	AH2334	5.28	KM38
170	180	M190x3	92	98	17	AH3036	2.83	KM38
	180	M200x3	105	110	17	AH2236	3.74	KM40
	180	M200x3	116	122	19	AH3136	3.81	KM40
	180	M190x3	116	127	16	AH24036	3.21	KM38
	180	M190x3	134	145	16	AH24136	3.74	KM38
	180	M200x3	140	146	24	AH3236	5.28	KM40
180	M200x3	154	160	26	AH2326	6.04	KM40	

Dimensions						Designation	Mass	The relevant parts	
d ₀	d	d _z	l	l ₁	h				Nuts
mm							kg		
180	190	Tr205x4	96	102	18	AH3038	3.35	HML41T	
	190	Tr210x4	112	117	18	AH2238	4.24	HM42T	
	190	M200x3	118	131	18	AH24038	3.51	KM40	
	190	Tr210x4	125	131	20	AH3138	4.45	HM42T	
	190	Tr210x4	145	152	25	AH3238	5.40	HM42T	
	190	M200x3	146	159	18	AH24138	4.42	KM40	
	190	Tr210x4	160	167	26	AH2338	6.20	HM42T	
	190	200	Tr215x4	102	108	19	AH3040	3.77	HML43T
		200	Tr220x4	118	123	19	AH2240	4.70	HM44T
200		Tr210x4	127	140	18	AH24040	3.98	HM42T	
200		Tr220x4	134	140	21	AH3140	5.63	HM44T	
200		Tr220x4	153	160	25	AH3240	6.61	HM44T	
200		Tr210x4	158	171	18	AH24140	5.03	HM42T	
200		Tr220x4	170	177	30	AH2340	7.62	HM44T	
200	220	Tr230x4	111	117	20	AH3044	7.40	HML47T	
	220	Tr240x4	130	136	20	AH2244	9.20	HM48T	
	220	Tr230x4	138	152	20	AOH24044	7.45	HM46T	
	220	Tr240x4	145	151	23	AH3144	9.30	HM48T	
	220	Tr230x4	170	184	20	AOH24144	10.00	HM46T	
	220	Tr240x4	181	189	30	AH2344	13.50	HM48T	
	220	240	Tr260x4	116	123	21	AH3048	7.95	HM52T
240		Tr250x4	138	153	20	AOH24048	8.05	HM50T	
240		Tr260x4	144	150	21	AH2248	11.10	HM52T	
240		Tr260x4	154	161	25	AH3148	12.00	HM52T	
240		Tr260x4	180	195	20	AOH24148	11.50	HM52T	
240		Tr260x4	189	197	30	AH2348	14.00	HM52T	
240		260	Tr280x4	128	135	23	AH3052	9.60	HM56T
	260	Tr290x4	155	161	23	AH2252	12.50	HM58T	
	260	Tr270x4	162	178	22	AOH24052	10.50	HM56T	
	260	Tr290x4	172	179	26	AH3152	16.00	HM58T	
	260	Tr280x4	202	218	22	AOH24152	14.00	HM56T	
	260	Tr290x4	205	213	30	AH2352	17.50	HM58T	
	260	280	Tr300x4	131	139	24	AH3056	11.00	HM3060
280		Tr300x4	155	163	24	AH2256	15.00	HM62T	
280		Tr300x4	162	179	22	AOH24056	13.50	HM58T	
280		Tr300x4	175	183	28	AH3156	17.00	HM62T	
280		Tr300x4	202	219	22	AOH24156	15.00	HM3160	
280		Tr300x4	212	220	30	AH2356	21.50	HM62T	

Withdrawal Sleeves

d = 280 – 380 mm

Locknuts and Withdrawal Nuts

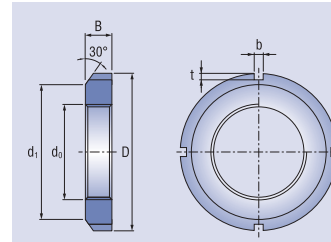
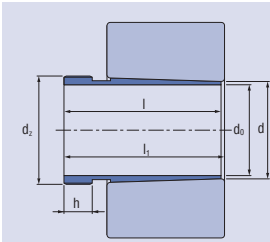

	Dimensions					Designation	Mass	The relevant parts
	d ₀	d	d _z	l	l ₁			
	mm						kg	
280	300	Tr320x5	145	153	26	AH3060	13.00	HM3064
	300	Tr330x5	170	178	26	AH2260	18.00	HM66T
	300	Tr310x5	184	202	24	AOH24060	14.00	HM62T
	300	Tr330x5	192	200	30	AH3160	19.00	HM66T
	300	Tr330x5	228	236	34	AH3260	23.50	HM66T
	300	Tr320x5	224	242	24	AOH24160	18.50	HM3164
300	320	Tr340x5	149	157	27	AH3064	16.50	HML69T
	320	Tr340x5	180	190	27	AH2264	20.00	HM70T
	320	Tr340x5	184	202	24	AOH24064	18.00	HM66T
	320	Tr340x5	209	217	31	AH3164	24.50	HM70T
	320	Tr340x5	246	254	36	AH3264	27.50	HM70T
	320	Tr340x5	242	260	24	AOH24164	20.50	HM3168
320	340	Tr365x5	162	171	28	AH3068	17.50	HML73T
	340	Tr360x5	206	225	26	AOH24068	18.00	HM3072
	340	Tr370x5	225	234	33	AH3168	26.50	HM74T
	340	Tr370x5	264	273	38	AH3268	32.00	HM74T
	340	Tr360x5	269	288	26	AOH24168	25.50	HM3172
	340	360	Tr385x5	167	176	30	AH3072	19.00
360		Tr380x5	206	226	26	AOH24072	20.00	HM76T
360		Tr400x5	229	238	35	AH3172	30.00	HM3180
360		Tr400x5	274	283	40	AH3272	33.00	HM3180
360		Tr380x5	269	289	26	AOH24172	26.00	HM3176
360		380	Tr400x5	170	180	31	AH3076	22.50
	380	Tr400x5	208	228	28	AOH24076	23.50	HM3080
	380	Tr400x5	232	242	36	AH3176	33.00	HM3184
	380	Tr400x5	284	294	42	AH3276	42.00	HM3184
	380	Tr400x5	271	291	28	AOH24176	31.00	HM3180
	380	400	Tr430x5	183	193	33	AH3080	27.00
400		Tr420x5	228	248	28	AOH24080	27.00	HM3084
400		Tr440x5	240	250	38	AH3180	39.50	HM3188
400		Tr440x5	303	312	44	AH3280	51.50	HM3188
400		Tr420x5	278	298	28	AOH24180	35.00	HM3184

	Dimensions					Designation	Mass	Relevant part-washer
	d ₀	d	d _z	D	l			
	mm						kg	
M17x1	24	28	5	4	2	KM3	0.012	MB3
M20x1	26	32	6	4	2	KM4	0.020	MB4
M25x1.5	32	38	7	5	2	KM5	0.028	MB5
M30x1.5	38	45	7	5	2	KM6	0.038	MB6
M35x1.5	44	52	8	5	2	KM7	0.058	MB7
M40x1.5	50	58	9	6	2.5	KM8	0.078	MB8
M45x1.5	56	65	10	6	2.5	KM9	0.11	MB9
M50x1.5	61	70	11	6	2.5	KM10	0.14	MB10
M55x2	67	75	11	7	3	KM11	0.15	MB11
M60x2	73	80	11	7	3	KM12	0.16	MB12
M65x2	79	85	12	7	3	KM13	0.19	MB13
M70x2	85	92	12	8	3.5	KM14	0.22	MB14
M75x2	90	98	13	8	3.5	KM15	0.27	MB15
M80x2	95	105	15	8	3.5	KM16	0.36	MB16
M85x2	102	110	16	8	3.5	KM17	0.42	MB17
M90x2	108	120	16	10	4	KM18	0.51	MB18
M95x2	113	125	17	10	4	KM19	0.58	MB19
M100x2	120	130	18	10	4	KM20	0.68	MB20
M105x2	126	140	18	12	5	KM21	0.81	MB21
M110x2	133	145	19	12	5	KM22	0.89	MB22
M115x2	137	150	19	12	5	KM23	0.91	MB23
M120x2	135	145	20	12	5	KML24	0.69	MBL24
	138	155	20	12	5	KM24	0.98	MB24
M125x2	148	160	21	12	5	KM25	1.12	MB25
M130x2	145	155	21	12	5	KML26	0.084	MBL26
	149	165	21	12	5	KM26	1.21	MB26
M135x2	160	175	22	14	6	KM27	1.39	MB27
M140x2	155	165	22	12	5	KML28	0.92	MBL28
	160	180	22	14	6	KM28	1.40	MB28
M145x2	171	190	22	14	6	KM29	1.65	MB29
	170	180	24	14	5	KML30	1.29	MBL30
M150x2	171	195	24	14	6	KM30	1.85	MB30
	182	200	25	16	7	KM31	2.05	MB31
M160x3	180	190	25	14	5	KML32	1.42	MBL32
	182	210	25	16	7	KM32	2.25	MB32
M165x3	193	210	26	16	7	KM33	2.31	MB33
M170x3	190	200	26	16	5	KML34	1.60	MBL34
	193	220	26	16	7	KM34	2.55	MB34
M180x3	200	210	27	16	5	KML36	1.82	MBL36
	203	230	27	18	8	KM36	2.70	MB36

Locknuts and Withdrawal Nuts

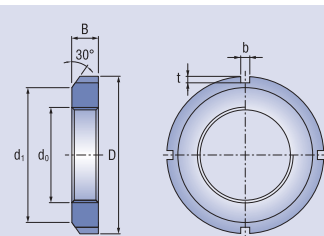

Dimensions						Designation	Mass	Relevant part-washer
d ₀	d	d _z	D	l	a			
mm							kg	
M190x3	210	220	28	16	5	KML38	1.90	MBL38
	214	240	28	18	8	KM38	3.04	MB38
M200x3	222	240	29	18	8	KML40	2.58	MBL40
	226	250	29	18	8	KM40	3.30	MB40
Tr205x4	232	250	30	18	8	HML41T	3.20	MBL41
Tr210x4	238	270	30	20	10	HM42T	4.22	MS42
TR215x4	242	260	30	20	9	HML43T	3.72	MSL43
Tr220x4	250	280	32	20	10	HM44T	4.84	MB44
Tr230x4	260	290	34	20	10	HM46T	5.40	MS46
Tr235x4	262	280	34	20	9	HML47T	4.10	MSL47
Tr240x4	270	300	34	20	10	HM48T	5.60	MB48
Tr250x4	290	320	36	20	10	HM50T	7.20	MS50
Tr260x4	300	330	36	24	12	HM52T	7.33	MB52
Tr280x4	320	350	38	24	12	HM56T	8.60	MS56
Tr290x4	330	370	40	24	12	HM58T	10.54	MS58
Tr300x4	336	360	42	24	12	HM3060	8.40	MS3060
	340	380	40	24	12	HM3160	10.60	MS3160
Tr310x5	350	390	42	24	12	HM62T	13.00	MS62
Tr320x5	356	380	42	24	12	HM3064	8.84	MS3064
	360	400	42	24	12	HM3164	11.82	MS3164
Tr330x5	380	420	52	28	15	HM66T	20.00	MS66
Tr340x5	400	440	55	28	15	HM3168	21.42	MS3168
Tr345x5	384	410	45	28	13	HML69T	13.00	MSL69
Tr350x5	410	450	55	28	15	HM70T	22.80	MS70
Tr360x5	394	420	45	28	13	HM3072	10.60	MS3072
	420	460	58	28	15	HM3172	24.00	MS3172
Tr365x5	404	430	48	28	13	HML73T	14.00	MSL73
Tr370x5	430	470	58	28	15	HM74T	28.00	MS74
Tr380x5	430	470	45	32	18	HM76T	20.20	MS76
Tr385x5	440	490	60	32	18	HM3176	28.20	MS3176
	422	450	48	28	14	HML77T	15.00	MSL77
Tr400x5	442	470	52	28	14	HM3080	16.00	MS3080
	460	520	62	32	18	HM3180	33.60	MS3180
Tr410x5	452	480	52	32	14	HML82T	19.00	MSL82
Tr420x5	462	490	52	32	14	HM3084	16.80	MS3084
	490	540	70	32	18	HM3184	40.40	MS3184
Tr430x5	472	500	52	32	14	HML86T	20.00	MS86
Tr440x5	510	560	70	36	20	HM3188	41.60	MS3188

Locking Washer

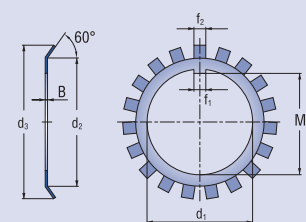

Dimensions							Washer marking	Mass of 100 pcs.
d ₁	d ₂	d ₃	B	f ₁	f ₂	M		
mm								kg
17	24	32	1	4	4	15.5	MB3	0.32
20	26	36	1	4	4	18.5	MB4	0.35
25	32	42	1.25	5	5	23	MB5	0.64
30	38	49	1.25	5	5	27.5	MB6	0.78
35	44	57	1.25	6	5	32.5	MB7	1.04
40	50	62	1.25	6	6	37.5	MB8	1.23
45	56	69	1.25	6	6	42.5	MB9	1.52
50	61	74	1.25	6	6	47.5	MB10	1.60
55	67	81	1.5	8	7	52.5	MB11	1.96
60	73	86	1.5	8	7	57.5	MB12	2.53
65	79	92	1.5	8	7	62.5	MB13	2.90
70	85	98	1.5	8	8	66.5	MB14	3.34
75	90	104	1.5	8	8	71.5	MB15	3.56
80	95	112	1.8	10	8	76.5	MB16	4.64
85	102	119	1.8	10	8	81.5	MB17	5.24
90	108	126	1.8	10	10	86.5	MB18	6.23
95	113	133	1.8	10	10	91.5	MB19	6.70
100	120	140	1.8	12	10	96.5	MB20	7.65
105	126	145	1.8	12	12	100.5	MB21	8.26
110	133	154	1.8	12	12	105.5	MB22	9.40
115	137	159	2	12	12	110.5	MB23	10.80
	135	148	2	14	12	115	MBL24	7.00
120	138	164	2	14	12	115	MB24	10.50
	148	170	2	14	12	120	MB25	11.80
130	145	158	2	14	12	125	MBL26	8.70
	149	175	2	14	12	125	MB26	11.30
135	160	185	2	14	14	130	MB27	14.40
140	155	170	2	16	12	135	MBL28	10.90
	160	192	2	16	14	135	MB28	14.20
145	172	202	2	16	14	140	MB29	14.80
	170	186	2	16	14	145	MBL30	11.30
150	171	205	2	16	14	145	MB30	15.50
	182	212	2.5	16	16	147.5	MB31	20.90
160	180	197	2.5	18	14	154	MBL32	16.20
	182	217	2.5	18	16	154	MB32	22.20
165	193	222	2.5	18	16	157.5	MB33	24.10
170	190	209	2.5	18	16	164	MBL34	17.00
	193	232	2.5	18	16	164	MB34	24.70

Locking Washer

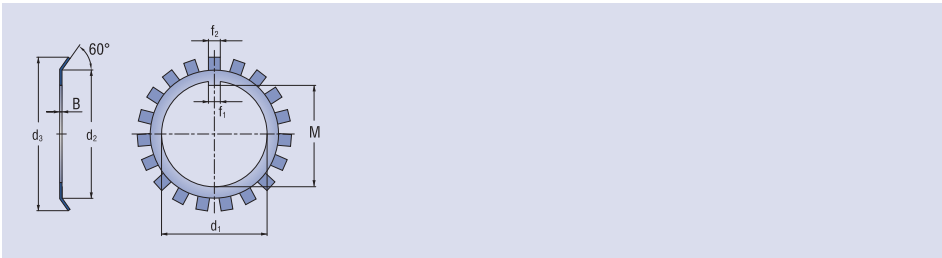

Dimensions							Washer marking	Mass of 100 pcs.	
d ₁	d ₂	d ₃	B	f ₁	f ₂	M		kg	
180	200	215	2.5	20	16	174	MBL36	18.00	
	203	242	2.5	20	18	174	MB36	26.80	
190	210	228	2.5	20	16	184	MBL38	20.50	
	214	252	2.5	20	18	184	MB38	27.80	
200	222	248	2.5	20	18	194	MBL40	21.40	
	226	262	2.5	20	18	194	MB40	29.30	
220	250	292	3.0	24	22	210	MB44	35.0	
240	270	312	3.0	24	22	233	MB48	45.0	
260	300	342	3.0	28	26	253	MB52	65.0	
280	320	362	3.0	28	26	273	MB56	105.0	



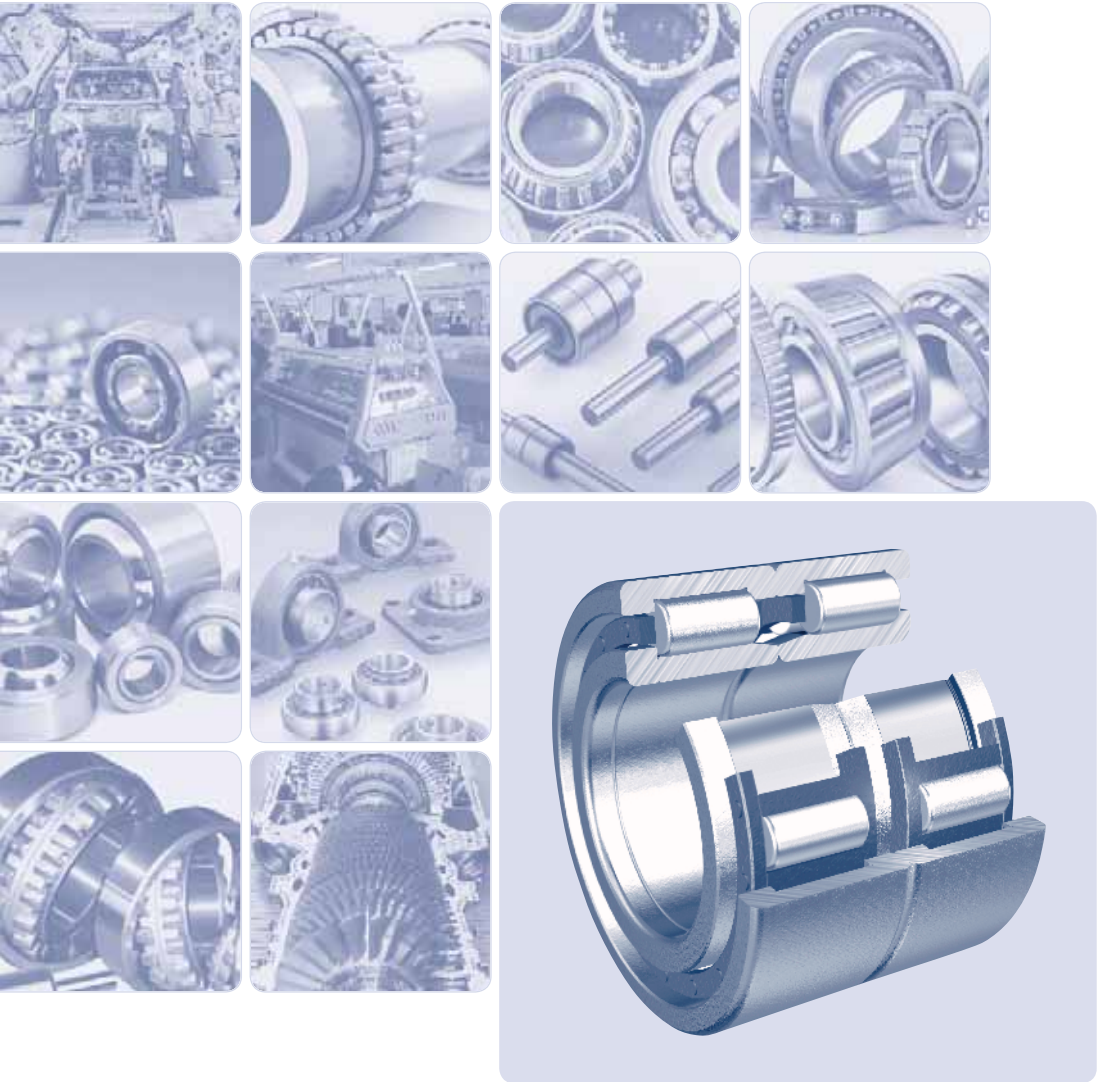

**Special Cylindrical Roller Bearings
for Railway Vehicles**

Special Cylindrical Roller Bearings for Railway Vehicles

KINEX bearings are used in railway vehicles for axleboxes, in traction motors and generators, in drives of blowers, in exciters and axle-driven generators, in compressors' motors and in gear-boxes.

For railway vehicle axleboxes the bearings with machined brass or plastic cages are manufactured. For higher speeds the internal design is specifically adapted.

The roller bearings with machined brass cages, in various design versions, are used mostly for traction motors and drives arrangements.

Under the term "railway vehicle" we understand:

- diesel and electric locomotives,
- diesel and electric motor train sets,
- motor coaches,
- passenger coaches,
- goods wagons,
- special railway vehicles.

The axle box bearing production is assured in compliance with the European standard EN 12080. The axle bearings correspond to the requirements of the European standard EN 12082, UIC 515-5.

Detailed information on bearings for railway vehicles (calculations, mounting, dismantling, maintenance...) are given in a special publication "Bearings for Railway Vehicles".

Single Row Cylindrical Roller Bearings for Railway Vehicle Axleboxes

d = 100 - 180 mm

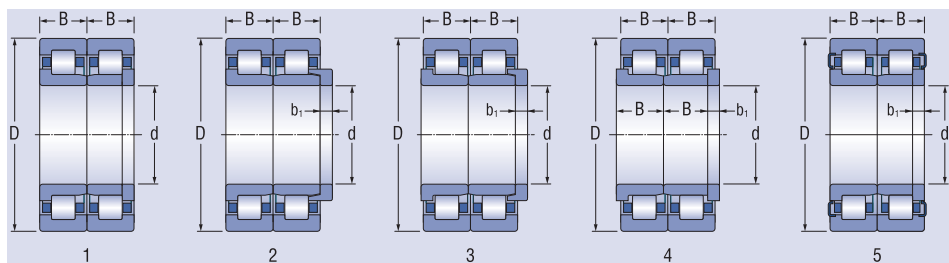

Dimensions				Bearing designation	Cage		Basic load rating		Maximum speed of rail vehicle	Mass of a pair of bearings	Pict.		
d	D	B	b ₁				d _r	C _r					C _{or}
mm													
100	180	60.3	-	PLC 49-200-2-1 (WJ100X180)	PLC 49-201-2 (WJP 100x180) ¹⁾³⁾⁴⁾	TNG		333.5	444.4	160	12.2	1	
	180	120.6	-	WJ/WJP 100x180x120,8 P TN C4		TNG		333.5	444.4	160	12.1	1	
110	215	73	-	PLC 410-207-1 (WJ110X215M)	PLC 410-208-1 (WJP 110x215M) ¹⁾⁴⁾⁵⁾	M		494.5	668.6	160	24.4	1	
	215	80	-	PLC 410-213-3	PLC410-214-3 ¹⁾⁴⁾⁵⁾	M		519.8	740.9	160	25.7	1	
	240	80	-	WJ 118x240x80 TN	WJP 118x240x80 P TN ¹⁾³⁾⁴⁾	TNG		553.8	742.5	160	32.4	1	
118	240	80	-	PLC 410-23	PLC 410-24 ¹⁾²⁾⁴⁾	TNG		553.8	742.5	160	34.2	1	
	240	80	-	WJ 118,5x240x80 TN	WJP 118,5x240x80 P TN ¹⁾³⁾⁴⁾	M		553.8	742.5	160	32.3	1	
	240	80	-	WJ 119x240x80 TN	WJP 119x240x80 P TN ¹⁾³⁾⁴⁾	TNG		553.8	742.5	160	32.1	1	
119.3	240	80	-	WJ 119,3x240x80 TN	WJP 119,3x240x80 P TN ¹⁾³⁾⁴⁾	TNG		553.8	742.5	160	32.1	1	
	200	62	-	PLC 49-202	PLC 49-203 ¹⁾⁴⁾⁵⁾	M		372.8	549.1	120	16	1	
	215	73	-	PLC 410-231-2 (WJ 120x215x73)	PLC 410-232-2 (WJP 120x215x73) ¹⁾³⁾⁴⁾	TNG		518.5	717.5	160	21	1	
120	215	80	-	PLC 410-213	PLC 410-214 ¹⁾²⁾⁴⁾	M		519.8	740.9	160	25.2	1	
	240	80	-	PLC 410-13	PLC 410-14 ¹⁾²⁾⁴⁾	M		553.8	742.5	160	33.7	1	
	240	80	-	PLC 410-13-1	PLC 410-14-1 ¹⁾⁴⁾⁵⁾	M		553.8	742.5	160	33.7	1	
	240	80	-	WJ 120x240x80 TN	WJP 120x240x80 P TN ¹⁾³⁾⁴⁾	TNG		553.8	742.5	160	31.9	1	
	240	80	-	PLC 410-15-3	PLC 410-16-3 ¹⁾³⁾⁴⁾	M		516.3	752.1	160	33.1	1	
	240	80	-	PLC 410-15-2-3 (WJ 128x240)	PLC 410-16-2-3 (WJP 128x240) ¹⁾³⁾⁴⁾	TNG		516.3	752.1	160	31	1	
128	240	80	-	WJ 128x240x80 TN	WJP 128x240x80 P TN ¹⁾³⁾⁴⁾	TNG		539.6	775.4	160	30.8	1	
	240	80	-	PLC 410-15-4	PLC 410-16-4 ¹⁾³⁾⁴⁾	M		516.3	752.1	160	32.9	1	
	240	80	-	PLC 410-15-2-4 (WJ 129x240)	PLC 410-16-2-4 (WJP 129x240) ¹⁾³⁾⁴⁾	TNG		516.3	752.1	160	30.8	1	
129	240	80	-	WJ 129x240x80 TN	WJP 129x240x80 P TN ¹⁾³⁾⁴⁾	TNG		539.6	775.4	160	30.6	1	
	240	80	-	WJ 129,3x240x80 TN	WJP 129,3x240x80 P TN ¹⁾³⁾⁴⁾	TNG		539.6	775.4	160	30.5	1	
	220	73	-	PLC 410-223-2	PLC 410-224-2 ¹⁾³⁾⁴⁾	TNG		505.0	761.7	160	21.08	1	
130	240	80	-	PLC 410-15	PLC 410-16 ¹⁾²⁾⁴⁾	M		516.3	752.1	160	32.6	1	
	240	80	-	PLC 410-15-2 (WJ 130x240)	PLC 410-16-2 (WJP 130x240) ¹⁾³⁾⁴⁾	TNG		516.3	752.1	160	30.4	1	
	240	80	-	PLC 410-33-1	PLC 410-34-1 ¹⁾²⁾⁴⁾	M		539.6	775.4	160	32.7	1	
	240	80	-	WJ 130x240x80 TN	WJP 130x240x80 P TN ¹⁾³⁾⁴⁾	TNG		539.6	775.4	160	30.3	1	
	240	86	21.55	WJ 130x240x80 TN	WJP 130x240x86 P TN ¹⁾³⁾⁴⁾	TNG		539.6	775.4	160	30.7		
	240	160	-	PLC 410-215/216		TNG		539.6	775.4	200	30.6	5	
	250	80	-	PLC 410-17	PLC 410-18 ¹⁾²⁾⁴⁾	M		580.0	800.3	160	36.3	1	
	250	80	-	PLC 410-17-2	PLC 410-18-2 ¹⁾³⁾⁴⁾	TNG		580.0	800.3	160	33.8	1	
	158	300	84	15	PLC 411-200	PLC 411-201 ¹⁾²⁾⁴⁾	M		869.5	1 214.3	160	58.3	2
	159	300	84	15	PLC 411-20	PLC 411-21 ¹⁾²⁾⁴⁾	M		869.5	1 214.3	160	57.9	2
160	300	84	15	PLC 411-10	PLC 411-12 ¹⁾²⁾⁴⁾	M		869.5	1 214.3	160	57.1	2	
180	320	86	12	NJ2236M C4A450-900	NUC2236M C4 + HJ2236X16.33 ²⁾⁴⁾	M		713.5	1 082.8	160	64.4	2	
	320	86	15	NJ2236XM C4	NUC2236M C4 + PLC 810-1	M		713.5	1 082.8	160	64.5	3	
	320	86	15	NJ2236XMAS C4	NUC2236MAS C4 + PLC 810-1	MAS		713.5	1 082.8	160	64.9	3	
	320	86	17	NJ2236XM C4	NUC2236M C4+príložný krúžok NUP2236	M		713.5	1 082.8	160	64.6	4	

¹⁾ Pair of bearings is marked shortly e. g. PLC410-13/14

²⁾ Machined brass cage (steel riveted) or-1 (cross piece riveted)

³⁾ Glass-fiber reinforced polyamide cage, roller centred

⁴⁾ Inner ring interchangeable

⁵⁾ Two-piece machined brass pronged cage

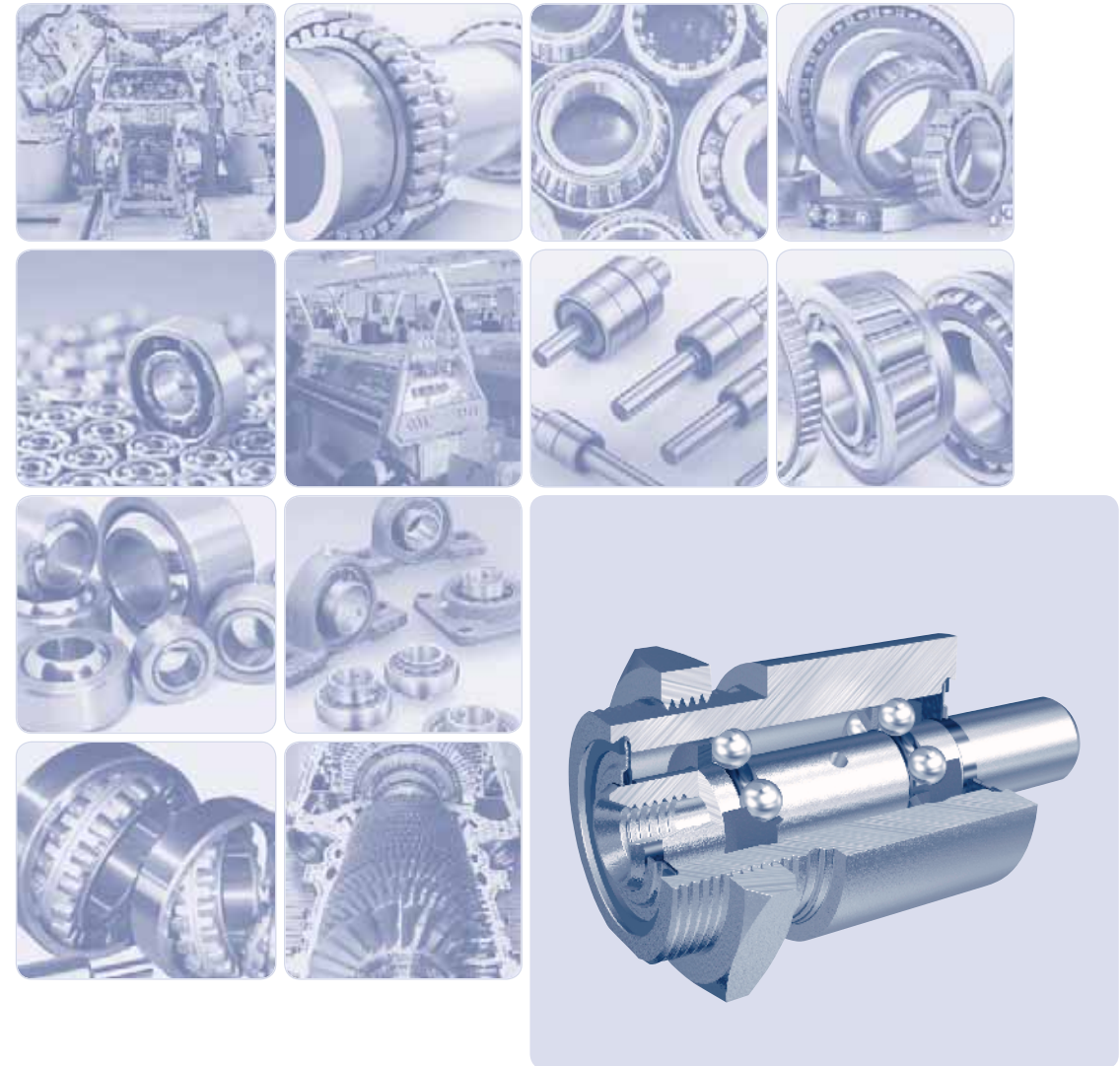

**Special Double Row Ball Bearings
for Textile Machines and Measuring Instruments**

Special Double Row Ball Bearings for Textile Machines and Measuring Instruments

Special double-row ball bearings for textile machines and measurement instruments built not separable unit, which consists of cylindrical bushing and shaft, arranged in two rows of balls. The balls are led in light one-sided cages. The raceways on the shaft and in cylindrical bushing are made in high accuracy degree. Effective contact or non-contact seals on both sides of bearings prevent penetration of impurities. The bearings are filled with a grease of high quality providing constant lubrication during their whole life. In some cases the design of the bushings makes possible relubrication during a bearings life.

A special double-row ball bearing creates a complete bearing unit which enables simple assembly and maintenance. The development of these bearing hangs together with a solution of arrangements of the most important parts in the textile machines but also for measuring instruments.

Special double-row ball bearing for textile machines are designed for high rotational speed and relatively light load. They are known for their high dimensional accuracy and smooth run warranting their high effectiveness. KINEX BEARINGS, a.s. supplies these bearings according to demand of the users complemented with some other components, e.g. pulleys drive discs. In some cases there are complete integrated bearing units which make from the technological and economical point of view possible the more effective production of textile machines.

Special double-row ball bearing for textile machines are used in shaping machines such as spindles of torsional units, in non-spindle spinning machines by housing a bearing of spinning chamber, of card strips disc etc.

Special double-row ball bearing for measuring instruments are known for their high dimensional accuracy as well as for operational reliability, but they are working at lower rotational speeds as the bearings in textile machines.

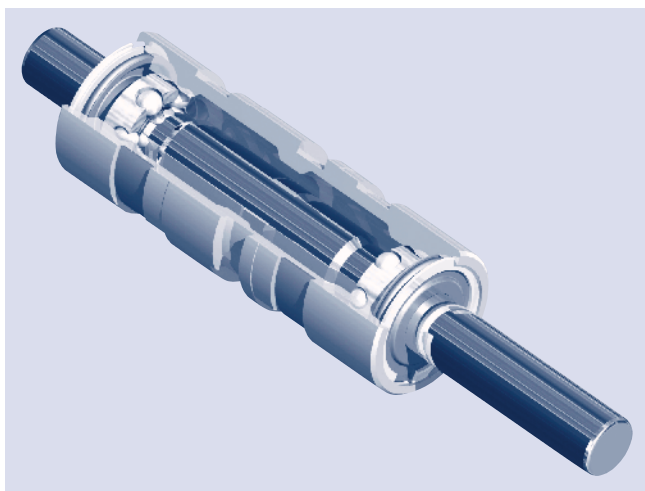

Special Double Row Ball Bearings for Textile Machines and Measuring Instruments

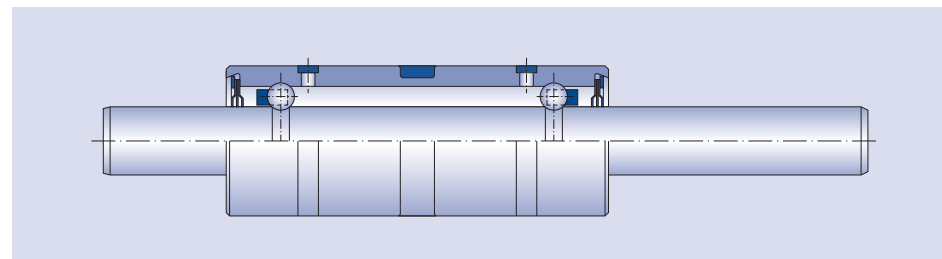

Bearing designation	Basic load ratings		Limiting Speed	
	dynamic C_r kN	static C_{0r}		
72-6	1.88	0.55	90 000	
73-1-13	2.00	0.69	40 000	
73-1-14	2.33	0.69	60 000	
73-1-14b	2.33	0.69	60 000	
73-1-20	2.33	0.69	40 000	
73-1-22	2.33	0.69	60 000	
73-1-24	2.33	0.69	75 000	
73-1-28	1.96	0.69	15 000	
73-1-31	2.33	0.69	80 000	
73-1-35	2.33	0.69	15 000	
73-1-36	1.96	0.69	15 000	
73-1-40	2.00	0.69	15 000	
73-1-43	1.96	0.69	15 000	
73-1-49	2.00	0.69	15 000	
73-1-64	2.00	0.69	60 000	
73-7-3	3.62	1.55	20 000	
73-7-4	3.62	1.55	8 000	
73-7-5	3.62	1.52	7 500	
76-3	5.11	2.35	10 000	
76-3-1	5.11	2.35	12 000	
76-3-7	5.11	2.35	10 000	
T001	1.88	0.55	90 000	
T004	1.62	0.48	80 000	
T010	1.31	0.38	105 000	
T011	1.31	0.38	105 000	
T013	1.31	0.38	105 000	
T100			110 000	
83-15			80 000	
83-18-5			105 000	
83-18-6			115 000	
83-23-1			100 000	

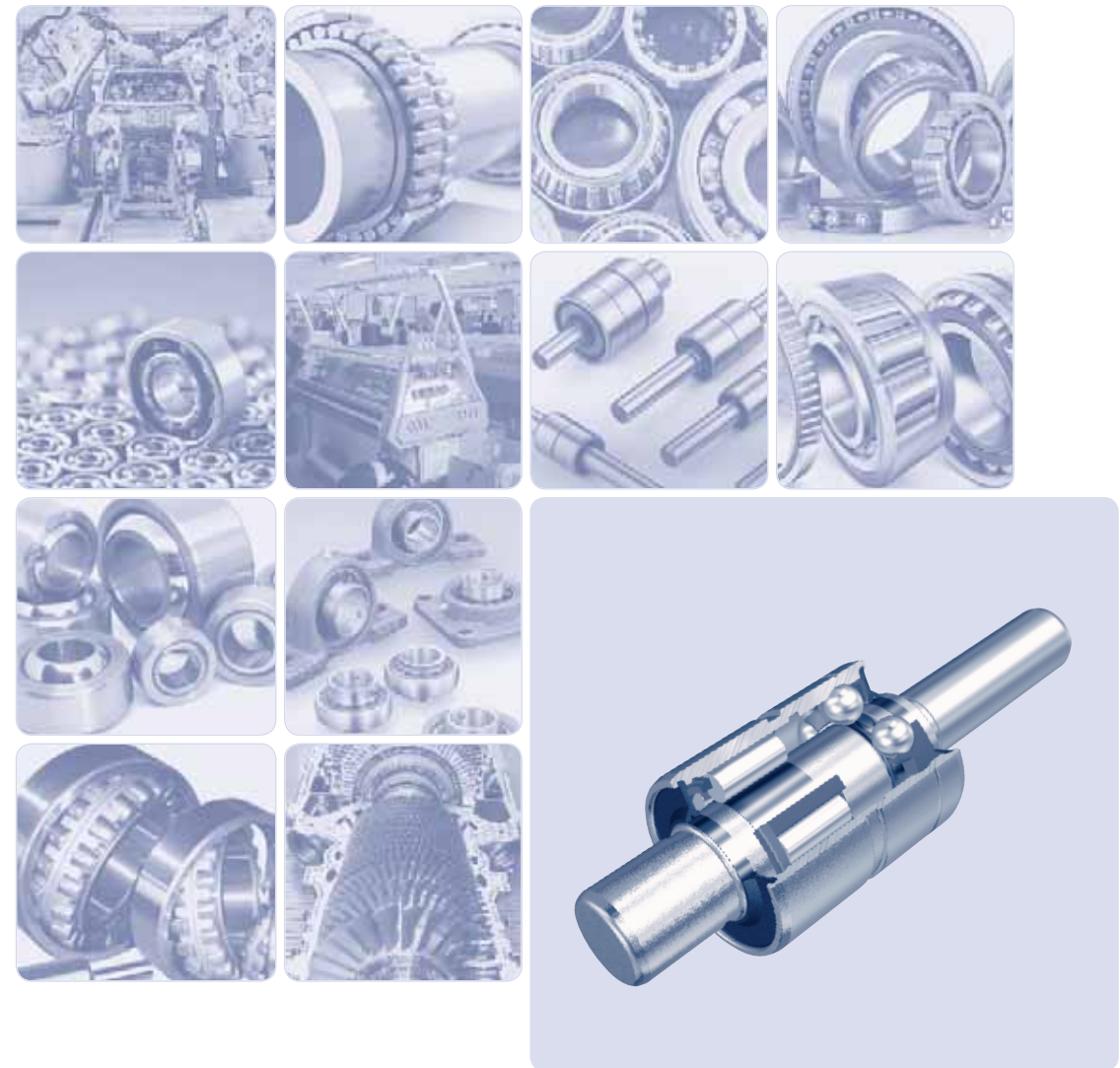

**Special Double Row Bearings
for Water Pumps of Combustion Engines**

Special Double Row Bearings for Water Pumps of Combustion Engines

The special double row bearings built not separable and sealed unit. They are composed of a shaft and cylindrical bushing which is arranged in two rows of rolling elements. The rolling elements are seated in light single-sided plastic cages. The raceways on the shaft and in the cylindrical bushing are produced with a very high degree of accuracy. In order to protect them against penetration of impurities, they are equipped on both sides by efficiency contact sealing. The bearings are filled with high quality grease, which provides the sufficient lubrication for the whole lifetime of the bearing. They have been designed to meet all customer's requirements for minimum weight, maximal compactness, high quality and stability of material and close quality supervision during the whole production process.

On the market, KINEX BEARINGS, a.s., presents three modifications of bearings for water pumps:

- **Double-row with two rows of balls - type K**

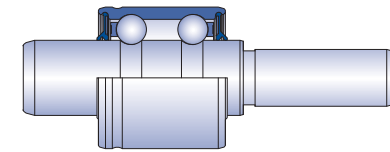

- **Double-row with one row of balls and one row of rollers - type R**

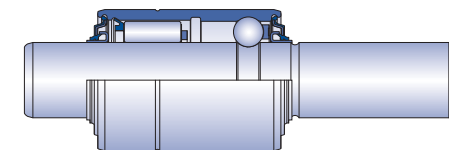

- **Triple-row with one row of balls and two rows of rollers**

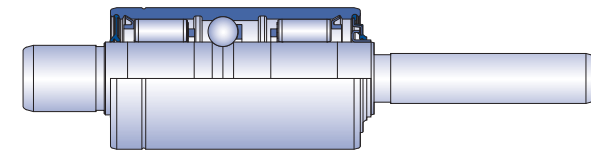

The R type is characteristic by significantly higher resistance against radial load on the cylindrical rollers row side. The rollers are placed on the loaded side of the bearings that extends its lifetime.

The bearings are designated by type (K or R) and three- or four-figures number. In certain cases the numbers is followed by OS or S which means, in comparison with bearing without OS or S that the special double-row bearing has been produced for repairs of water pumps.

Bearings are produced with four types of seals:

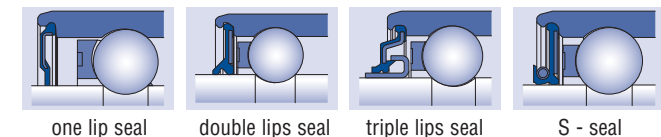

Seals are made of materials NBR, HNBR, FKM.

Water pump bearings type K

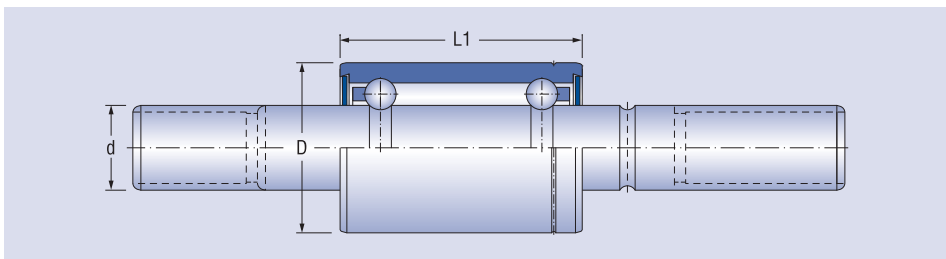

D mm	L1 mm	d mm	
24	19,9 - 33,5	12,000	
26	30,0 - 40,0	12,000	
28	20,0	15,918	
30	22,0 - 59,0	15,000	
	22,0 - 59,0	15,918	
	22,0 - 59,0	16,000	
	22,0 - 59,0	17,200	
32	45,0	16,000	
34	30,0 - 47,0	17,000	
35	29,9 - 46,0	15,918	
	29,9 - 54,0	16,000	
	29,9 - 56	17,500	
36	30,0 - 60,0	16,000	
	30,0 - 60,0	17,000	
	30,0 - 60,0	18,961	
	30,0 - 60,0	20,000	
38	38,9 - 58,0	18,961	
40	38,9 - 62,0	15,918	
	42,0 - 62,0	17,000	
	42,0 - 62,0	18,961	
	24,0 - 25,0	19,012	
	42,0 - 62,0	20,000	
	22,0	24,500	
42	42,0 - 46,0	16,000	
	39,0	18,961	
	42,0 - 46,0	20,000	
	32,0	22,000	
47	30,0 - 75,0	20,000	
	30,0 - 75,0	25,400	
52	59,0	25,061	

Water pump bearings type R

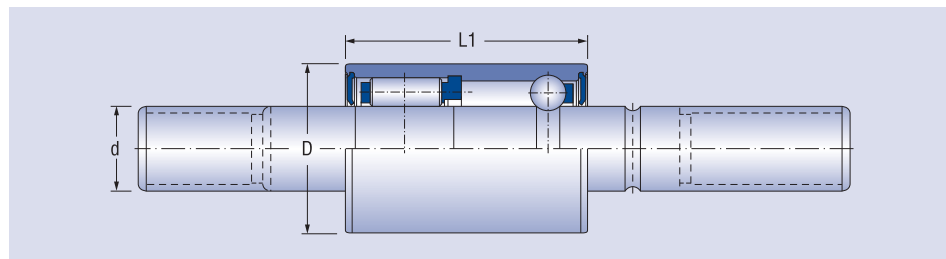

D mm	L1 mm	d mm	
56	70,0	25,000	
24	26,9	12,008	
28	20 - 27	17,200	
30	27,0 - 52,0	15,000	
	22,9 - 52	15,918	
	27,0 - 52,0	16,000	
	27,0 - 52,0	17,200	
30,254	38,9 - 52	15,918	
35	38,9 - 56,0	18,961	
36	40,0 - 56,0	18,961	
38	41,1 - 54,1	18,961	
40	38,9 - 52,5	18,961	
	38,9 - 52,5	20,000	
41	38,9 - 52,5	20,000	
42	32,0 - 52,5	20,000	
47,587	69,85	25,362	
47,625	54,1 - 69,9	25,400	
52	53,5	25,000	
55	60,0 - 75,0	25,000	



